

Programming Guide

Agilent Technologies EPM-P Series Power Meters



Agilent Technologies

**Agilent Technologies Part no. E4416-90029
Fourth Edition, March 5, 2013**

© Copyright 2000–2013 Agilent Technologies

All rights reserved. Reproduction, adaptation, or translation without prior written permission is prohibited, except as allowed under the copyright laws.

Printed in Malaysia.

Equipment Operation

Warnings and Cautions

This guide uses warnings and cautions to denote hazards.

WARNING

A warning calls attention to a procedure, practice or the like, which, if not correctly performed or adhered to, could result in injury or the loss of life. Do not proceed beyond a warning until the indicated conditions are fully understood and met.

Caution

A caution calls attention to a procedure, practice or the like which, if not correctly performed or adhered to, could result in damage to or the destruction of part or all of the equipment. Do not proceed beyond a caution until the indicated conditions are fully understood and met.

Personal Safety Considerations

WARNING

This is a Safety Class I product (provided with a protective earthing ground incorporated in the power cord). The mains plug shall only be inserted in a socket outlet provided with a protective earth contact. Any interruption of the protective conductor, inside or outside the instrument, is likely to make the instrument dangerous. Intentional interruption is prohibited.

If this instrument is not used as specified, the protection provided by the equipment could be impaired. This instrument must be used in a normal condition (in which all means of protection are intact) only.

No operator serviceable parts inside. Refer servicing to qualified personnel. To prevent electrical shock, do not remove covers.

For continued protection against fire hazard, replace the line fuse(s) only with fuses of the same type and rating (for example, normal blow, time delay, etc.). The use of other fuses or material is prohibited.

General Safety Considerations

WARNING

Before this instrument is switched on, make sure it has been properly grounded through the protective conductor of the ac power cable to a socket outlet provided with protective earth contact. Any interruption of the protective (grounding) conductor, inside or outside the instrument, or disconnection of the protective earth terminal can result in personal injury.

Caution

Any adjustments or service procedures that require operation of the instrument with protective covers removed should be performed only by trained service personnel.

User Environment

The product is suitable for indoor use only.

About this Guide

Chapter 1: Power Meter Remote Operation

This chapter describes the parameters which configure the power meter and helps you determine settings to optimize performance.

Chapter 2: MEASurement Instructions

This chapter explains how to use the MEASure group of instructions to acquire data using a set of high level instructions.

Chapter 3: CALCulate Subsystem

This chapter explains how to use the CALCulate subsystem to perform post acquisition data processing.

Chapter 4: CALibration Subsystem

This chapter explains how to use the CALibration command subsystem to zero and calibrate the power meter.

Chapter 5: DISPlay Subsystem

This chapter explains how the DISPlay subsystem is used to control the the selection and presentation of the windows used on the power meter's display.

Chapter 6: FORMat Subsystem

This chapter explains how the FORMat subsystem is used to set a data format for transferring numeric information.

Chapter 7: MEMory Subsystem

This chapter explains how the MEMory command subsystem is used to create, edit and review sensor calibration tables.

Chapter 8: OUTput Subsystem

This chapter explains how the OUTput command subsystem is used to switch the POWER REF output on and off.

About this Guide

Chapter 9: SENSE Subsystem

This chapter explains how the `SENSE` command subsystem directly affects device specific settings used to make measurements.

Chapter 10: STATUS Subsystem

This chapter explains how the `STATUS` command subsystem enables you to examine the status of the power meter by monitoring the “Device Status Register”, “Operation Status Register” and the “Questionable Status Register”.

Chapter 11: SYSTEM Subsystem

This chapter explains how to use the `SYSTEM` command subsystem to return error numbers and messages from the power meter, preset the power meter, set the GPIB address, set the command language and query the SCPI version.

Chapter 12: TRACE Subsystem

This chapter explains how to use the `TRACE` command subsystem to configure and read back the measured power trace.

Chapter 13: TRIGGER Subsystem

This chapter explains how the `TRIGGER` command subsystem is used to synchronize device actions with events.

Chapter 14: UNIT Subsystem

This chapter explains how to use the `UNIT` command subsystem to set the power meter measurement units to Watts and % (linear), or dBm and dB (logarithmic).

Chapter 15: SERVICE Subsystem

This chapter explains how to use the `SERVICE` command subsystem to obtain and set information useful for servicing the power meter.

Chapter 16: IEEE488.2 Command Reference

This chapter contains information about the IEEE488.2 Common Commands that the power meter supports.

Appendix A

This appendix contains information about the calibration factor block layout.

Related Publications

The *EPM-P Series Power Meters User's Guide* is available on the CD-ROM and in the following languages:

- English Language User's Guide - Standard
- German Language User's Guide - Option ABD
- Spanish Language User's Guide - Option ABE
- French Language User's Guide - Option ABF
- Italian Language User's Guide - Option ABZ
- Japanese Language User's Guide - Option ABJ

Useful information on SCPI (Standard Commands for Programmable Instruments) can be found in:

- *A Beginner's Guide to SCPI*, which is available by ordering Agilent Part Number 5010-7166.
- The SCPI reference manuals which are available from:
SCPI Consortium,
8380 Hercules Drive, Suite P3,
La Mesa, CA 91942, USA.
Telephone: 619-697-4301
Fax: 619-697-5955

Table of Contents

	Page
Equipment Operation	-iii
Personal Safety Considerations	-iii
General Safety Considerations	-iv
User Environment	-iv
About this Guide	-v
Related Publications	-viii
Table of Contents	Contents-1
List of Tables	Tables-1
List of Figures	Figures-1
Power Meter Remote Operation	1-1
Introduction	1-2
Configuring the Remote Interface	1-3
Interface election	1-3
GPIB Address	1-3
RS232/RS422 Configuration	1-4
Zeroing and Calibrating the Power Meter	1-5
Zeroing	1-5
Calibration	1-5
Setting the Reference Calibration Factor	1-7
Making Measurements	1-8
Using MEASure?	1-9
Using the CONFigure Command	1-14
Using the Lower Level Commands	1-23
Making Measurements on Wireless Communication Standards	1-24
Measuring GSM	1-24
Measuring EDGE	1-25
Measuring NADC	1-27
Measuring iDEN	1-30
Measuring Bluetooth	1-32
Measuring cdmaOne	1-34
Measuring W-CDMA	1-36
Measuring cdma2000	1-38

Using Sensor Calibration Tables	1-40
Overview	1-40
Editing Sensor Calibration Tables	1-43
Selecting a Sensor Calibration Table	1-48
Enabling the Sensor Calibration Table System	1-48
Making the Measurement	1-49
Using Frequency Dependent Offset Tables	1-50
Overview	1-50
Editing Frequency Dependent Offset Tables	1-52
Selecting a Frequency Dependent Offset Table	1-55
Enabling A Frequency Dependent Offset Table	1-55
Making The Measurement	1-55
Setting the Range, Resolution and Averaging	1-57
Range	1-57
Resolution	1-58
Averaging	1-58
Setting Offsets	1-61
Channel Offsets	1-61
Display Offsets	1-61
Example	1-62
Setting Measurement Limits	1-63
Setting Limits	1-64
Checking for Limit Failures	1-65
Example	1-66
Measuring Pulsed Signals	1-67
Using Duty Cycle	1-67
Making the Measurement	1-67
Getting the Best Speed Performance	1-70
Measurement Rate	1-70
Sensor	1-71
Trigger Mode	1-71
Output Format	1-72
Units	1-72
Command Used	1-73
Fast Mode	1-73
How Measurements are Calculated	1-74
Status Reporting	1-75
The General Status Register Model	1-76
How to Use Registers	1-78
Status Registers	1-83
Using the Operation Complete Commands	1-93
Saving and Recalling Power Meter Configurations	1-95
How to Save and Recall a Configuration	1-95

Example Program.....	1-95
Using Device Clear to Halt Measurements	1-96
An Introduction to the SCPI Language	1-97
Syntax Conventions	1-99
SCPI Data Types	1-99
Input Message Terminators.....	1-105
Summary Of Commands	1-106
MEASurement Commands	1-107
CALCulate Subsystem	1-108
CALibration Subsystem	1-109
DISPlay Subsystem	1-109
FORMat Subsystem	1-109
MEMory Subsystem	1-111
OUTPut Subsystem	1-111
[SENSe] Subsystem	1-113
STATus Subsystem	1-115
SYSTem Subsystem	1-116
TRACe Subsystem	1-116
TRIGger Subsystem.....	1-117
UNIT Subsystem	1-117
SERvice Subsystem	1-118
SCPI Compliance Information	1-119

Measurement Commands.....	2-1
Measurement Commands.....	2-2
CONFigure[1]2 3 4?	2-6
CONFigure[1]2 3 4 Commands.....	2-8
CONFigure[1]2 3 4[:SCALar][:POWer:AC] [<expected_value>[,<resolution>[,<source list>]]]	2-9
CONFigure[1]2 3 4[:SCALar][:POWer:AC]:RELative [<expected_value>[,<resolution>[,<source list>]]]	2-11
CONFigure[1]2 3 4[:SCALar][:POWer:AC]:DIFFerence [<expected_value>[,<resolution>[,<source list>]]]	2-13
CONFigure[1]2 3 4[:SCALar][:POWer:AC]:DIFFerence:RELative [<expected_value>[,<resolution>[,<source list>]]]	2-15
CONFigure[1]2 3 4[:SCALar][:POWer:AC]:RATio [<expected_value>[,<resolution>[,<source list>]]]	2-17
CONFigure[1]2 3 4[:SCALar][:POWer:AC]:RATio:RELative [<expected_value>[,<resolution>[,<source list>]]]	2-19
FETCh[1]2 3 4 Queries.....	2-21
FETCh[1]2 3 4[:SCALar][:POWer:AC]? [<expected_value>[,<resolution>[,<source list>]]]	2-22
FETCh[1]2 3 4[:SCALar][:POWer:AC]:RELative?	

[<expected_value>[,<resolution>[,<source list>]]].....	2-24
FETCh[1]2 3 4[:SCALar][:POWer:AC]:DIFFerence?	
[<expected_value>[,<resolution>[,<source list>]]].....	2-27
FETCh[1]2 3 4[:SCALar][:POWer:AC]:DIFFerence:RELative?	
[<expected_value>[,<resolution>[,<source list>]]].....	2-29
FETCh[1]2 3 4[:SCALar][:POWer:AC]:RATio?	
[<expected_value>[,<resolution>[,<source list>]]].....	2-31
FETCh[1]2 3 4[:SCALar][:POWer:AC]:RATio:RELative?	
[<expected_value>[,<resolution>[,<source list>]]].....	2-33
READ[1]2 3 4 Commands	2-35
READ[1]2 3 4[:SCALar][:POWer:AC]? [<expected_value>[,<resolu- tion>[,<source list>]]].....	2-36
READ[1]2 3 4[:SCALar][:POWer:AC]:RELative?	
[<expected_value>[,<resolution>[,<source list>]]].....	2-38
READ[1]2 3 4[:SCALar][:POWer:AC]:DIFFerence?	
[<expected_value>[,<resolution>[,<source list>]]].....	2-41
READ[1]2 3 4[:SCALar][:POWer:AC]:DIFFerence:RELative?	
[<expected_value>[,<resolution>[,<source list>]]].....	2-43
READ[1]2 3 4[:SCALar][:POWer:AC]:RATio? [<expected_value>[,<resolu- tion>[,<source list>]]].....	2-45
READ[1]2 3 4[:SCALar][:POWer:AC]:RATio:RELative?	
[<expected_value>[,<resolution>[,<source list>]]].....	2-47
MEASure[1]2 3 4 Commands	2-49
MEASure[1]2 3 4[:SCALar][:POWer:AC]? [<expected_value>[,<resolu- tion>[,<source list>]]].....	2-50
MEASure[1]2 3 4[:SCALar][:POWer:AC]:RELative?	
[<expected_value>[,<resolution>[,<source list>]]].....	2-52
MEASure[1]2 3 4[:SCALar][:POWer:AC]:DIFFerence?	
[<expected_value>[,<resolution>[,<source list>]]].....	2-54
MEASure[1]2 3 4[:SCALar][:POWer:AC]:DIFFerence:RELative?	
[<expected_value>[,<resolution>[,<source list>]]].....	2-56
MEASure[1]2 3 4[:SCALar][:POWer:AC]:RATio?	
[<expected_value>[,<resolution>[,<source list>]]].....	2-58
MEASure[1]2 3 4[:SCALar][:POWer:AC]:RATio:RELative?	
[<expected_value>[,<resolution>[,<source list>]]].....	2-60

CALCulate Subsystem	3-1
CALCulate Subsystem	3-2
CALCulate[1]2 3 4:FEED[1]2 <string>	3-4
CALCulate[1]2 3 4:GAIN Commands	3-6
CALCulate[1]2 3 4:GAIN[:MAGNitude] <numeric_value>	3-7
CALCulate[1]2 3 4:GAIN:STATe <boolean>	3-9
CALCulate[1]2 3 4:LIMit Commands	3-11

CALCulate[1] 2 3 4:LIMit:CLEar:AUTO <boolean> ONCE	3-12
CALCulate[1] 2 3 4:Limit:CLEar[:IMMediate]	3-14
CALCulate[1] 2 3 4LIMit:FAIL?	3-15
CALCulate[1] 2 3 4:LIMit:FCOut?	3-16
CALCulate[1] 2 3 4:LIMit:LOWer[:DATA] <numeric_value>	3-18
CALCulate[1] 2 3 4:LIMit:UPPer[:DATA] <numeric_value>	3-20
CALCulate[1] 2 3 4:LIMit:STATe <boolean>	3-22
CALCulate[1] 2 3 4:MATH Commands	3-24
CALCulate[1] 2 3 4:MATH[:EXPRession] <string>	3-25
CALCulate[1] 2 3 4:MATH[:EXPRession]:CATalog?	3-27
CALCulate[1] 2 3 4:PHOLd:CLEar	3-28
CALCulate[1] 2 3 4:RELative Commands.....	3-29
CALCulate[1] 2 3 4:RELative[:MAGNitude]:AUTO <boolean> ONCE .	3-30
CALCulate[1] 2 3 4:RELative:STATe <boolean>	3-32
CALibration Subsystem	4-1
CALibration Subsystem	4-2
CALibration[1] 2[:ALL]	4-3
CALibration[1] 2[:ALL]?.....	4-5
CALibration[1] 2:AUTO <boolean>.....	4-7
CALibration[1] 2:ECONtrol:STATe <boolean>	4-9
CALibration[1] 2:RCALibration <boolean>	4-10
CALibration[1] 2:RCFactor <numeric_value>	4-12
CALibration[1] 2:ZERO:AUTO <boolean>	4-14
CALibration[1] 2:ZERO:NORMAl:AUTO <boolean>	4-15
DISPlay Subsystem	5-1
DISPlay Subsystem	5-2
DISPlay:CONTRast <numeric_value>	5-3
DISPlay:ENABle <boolean>	5-5
DISPlay:SCREen:FORMat <character_data>	5-6
DISPlay[:WINDow[1] 2] Commands	5-8
DISPlay[:WINDow[1] 2]:ANALog Commands	5-9
DISPlay[:WINDow[1] 2]:ANALog:LOWer <numeric_value>	5-10
DISPlay[:WINDow[1] 2]:ANALog:UPPer <numeric_value>	5-12
DISPlay[:WINDow[1] 2]:FORMat <character_data>	5-14
DISPlay[:WINDow[1] 2]:METer Commands	5-16
DISPlay[:WINDow[1] 2]:METer:LOWer <numeric_value>	5-17
DISPlay[:WINDow[1] 2]:METer:UPPer <numeric_value>	5-19
DISPlay[:WINDow[1] 2][:NUMeric[1] 2]:RESolution <numeric_value>	5-21
DISPlay[:WINDow[1] 2]:SELect[1] 2	5-23
DISPlay[:WINDow[1] 2][:STATe] <boolean>	5-24
DISPlay[:WINDow[1] 2]:TRACe:FEED <character_data>.....	5-26
DISPlay[:WINDow[1] 2]:TRACe:LOWer <numeric_value>	5-28

DISPlay[:WINDow[1] 2]:TRACe:UPPer <numeric_value>	5-30
FORMat Subsystem	6-1
FORMat Subsystem	6-2
FORMat[:READings]:BORDER <character_data>	6-3
FORMat[:READings][:DATA] <character_data>	6-4
MEMory Subsystem	7-1
MEMory Subsystem	7-2
MEMory:CATalog Commands	7-4
MEMory:CATalog[:ALL]?	7-5
MEMory:CATalog:STATe?	7-7
MEMory:CATalog:TABLE?	7-8
MEMory:CLEar Commands	7-10
MEMory:CLEar[:NAME] <character_data>	7-11
MEMory:CLEar:TABLE	7-12
The MEMory:FREE Commands	7-13
MEMory:FREE[:ALL]?	7-14
MEMory:FREE:STATe?	7-15
MEMory:FREE:TABLE?	7-16
MEMory:NStates?	7-17
The MEMory:STATe Commands	7-18
MEMory:STATe:CATalog?	7-19
MEMory:STATe:DEFine <character_data>,<numeric_value>	7-20
MEMory:TABLE Commands	7-21
MEMory:TABLE:FREQuency <numeric_value>{,<numeric_value>}	7-22
MEMory:TABLE:FREQuency:POINts?	7-25
MEMory:TABLE:GAIN[:MAGNitude] <numeric_value>{,<numeric_value>} 7-26	
MEMory:TABLE:GAIN[:MAGNitude]:POINts?	7-28
MEMory:TABLE:MOVE <character_data>,<character_data>	7-29
MEMory:TABLE:SElect <character_data>	7-30
OUTPut Subsystem	8-1
OUTPut Subsystem	8-2
OUTPut:RECOOrder[1] 2:FEED <data_handle>	8-3
OUTPut:RECOOrder[1] 2:LIMit:LOWer <numeric_value>	8-5
OUTPut:RECOOrder[1] 2:LIMit:UPPer <numeric_value>	8-7
OUTPut:RECOOrder[1] 2:STATe <boolean>	8-9
OUTPut:ROSCillator[:STATe] <boolean>	8-10
OUTPut:TRIGger[:STATe] <boolean>	8-11
OUTPut:TTL[1] 2:ACTive HIGH LOW	8-12
OUTPut:TTL[1] 2:FEED <string>	8-14
OUTPut:TTL[1] 2:STATe <boolean>	8-16

SENSe Subsystem	9-1
[SENSe] Subsystem	9-2
[SENSe[1]]SENSe2:AVERAge Commands	9-5
[SENSe[1]]SENSe2:AVERAge:COUNT <numeric_value>	9-6
[SENSe[1]]SENSe2:AVERAge:COUNT:AUTO <boolean>	9-8
[SENSe[1]]SENSe2:AVERAge:SDETECT <boolean>	9-11
[SENSe[1]]SENSe2:AVERAge[:STATe] <boolean>	9-13
[SENSe[1]]SENSe2:AVERAge2 Commands.....	9-14
[SENSe[1]]SENSe2:AVERAge2:COUNT <numeric_value>	9-15
[SENSe[1]]SENSe2:AVERAge2[:STATe] <boolean>	9-17
[SENSe[1]]SENSe2:BANDwidth BWIDTH:VIDEo <character_data>	9-18
[SENSe[1]]SENSe2:CORREction Commands	9-20
[SENSe[1]]SENSe2:CORREction:CFACtor GAIN[1][:INPut][:MAGNitude]	
<numeric_value>	9-21
[SENSe[1]]SENSe2:CORREction:CSET[1] CSET2 Commands	9-23
[SENSe[1]]SENSe2:CORREction:CSET[1] CSET2[:SElect] <string> ..	9-24
[SENSe[1]]SENSe2:CORREction:CSET[1] CSET2:STATe <boolean> .	9-26
[SENSe[1]]SENSe2:CORREction:DCYClE GAIN3 Commands	9-28
[SENSe[1]]SENSe2:CORREction:DCYClE GAIN3[:INPut][:MAGNitude]	
<numeric_value>	9-29
[SENSe[1]]SENSe2:CORREction:DCYClE GAIN3:STATe <boolean> .	9-32
[SENSe[1]]SENSe2:CORREction:FDOFfset GAIN4[:INPut][:MAGNitude]?	
9-34	
[SENSe[1]]SENSe2:CORREction:GAIN2 Commands	9-35
[SENSe[1]]SENSe2:CORREction:GAIN2:STATe <boolean>	9-36
[SENSe[1]]SENSe2:CORREction:GAIN2[:INPut][:MAGNitude]	
<numeric_value>	9-38
[SENSe[1]]SENSe2:DETEctor:FUNCTion <character_data>	9-40
[SENSe[1]]SENSe2:FREQuency[:CW :FIXed] <numeric_value>	9-42
[SENSe[1]]SENSe2:MRATE <character_data>	9-44
[SENSe[1]]SENSe2:POWer:AC:RANGe <numeric_value>	9-46
[SENSe[1]]SENSe2:POWer:AC:RANGe:AUTO <boolean>	9-47
[SENSe[1]]SENSe2:SPEEd <numeric_value>	9-49
[SENSe[1]]SENSe2:SWEEp[1] 2 3 4 Commands	9-51
[SENSe[1]]SENSe2:SWEEp[1] 2 3 4:OFFSet:TIME <numeric_value> .	9-52
[SENSe[1]]SENSe2:SWEEp[1] 2 3 4:TIME <numeric_value>	9-54
[SENSe[1]]SENSe2:TRACe Commands	9-56
[SENSe[1]]2:TRACe:LIMit:LOWer <numeric_value>	9-57
[SENSe[1]]2:TRACe:LIMit:UPPer <numeric_value>	9-59
[SENSe[1]]SENSe2:TRACe:OFFSet:TIME <numeric_value>	9-61
[SENSe[1]]SENSe2:TRACe:TIME <numeric_value>	9-63
[SENSe[1]]SENSe2:TRACe:UNIT <character_data>	9-65
[SENSe[1]]SENSe2:V2P ATYPe DTYPE	9-66

STATus Subsystem	10-1
STATus Subsystem	10-2
Status Register Set Commands	10-4
Device Status Register Sets	10-8
Operation Register Sets	10-10
STATus:OPERation	10-11
STATus:OPERation:CALibrating[:SUMMARY]	10-12
STATus:OPERation:LLFail[:SUMMARY]	10-13
STATus:OPERation:MEASuring[:SUMMARY]	10-14
STATus:OPERation:SENSE[:SUMMARY]	10-15
STATus:OPERation:TRIGger[:SUMMARY]	10-16
STATus:OPERation:ULFail[:SUMMARY]	10-17
STATus:PRESet	10-18
Questionable Register Sets	10-19
STATus:QUEStionable	10-20
STATus:QUEStionable:CALibration[:SUMMARY]	10-21
STATus:QUEStionable:POWer[:SUMMARY]	10-22
Status Block Diagram	10-25
SYSTem Subsystem	11-1
SYSTem Subsystem	11-2
SYSTem:COMMunicate:GPIB[:SELF]:ADDRess <numeric_value> ..	11-4
SYSTem:COMMunicate:Serial Commands	11-6
SYSTem:COMMunicate:SERial:CONTRol:DTR <boolean>	11-7
SYSTem:COMMunicate:SERial:CONTRol:RTS <boolean>	11-8
SYSTem:COMMunicate:SERial[:RECeive]:BAUD <numeric_value> ..	11-9
SYSTem:COMMunicate:SERial[:RECeive]:BITs <numeric_value> ..	11-11
SYSTem:COMMunicate:SERial[:RECeive]:PACE XON NONE	11-13
SYSTem:COMMunicate:SERial[:RECeive]:PARity[:TYPE] EVEN ODD ZE- RO ONE NONE	11-14
SYSTem:COMMunicate:SERial[:RECeive]:SBITs <numeric_value> ..	11-16
SYSTem:COMMunicate:SERial:TRANSmIt:AUTO?	11-17
SYSTem:COMMunicate:SERial:TRANSmIt:BAUD <numeric_value> ..	11-18
SYSTem:COMMunicate:SERial:TRANSmIt:BITs <numeric_value> ..	11-20
SYSTem:COMMunicate:SERial:TRANSmIt:ECHO <boolean>	11-21
SYSTem:COMMunicate:SERial:TRANSmIt:PACE XON NONE	11-22
SYSTem:COMMunicate:SERial:TRANSmIt:PARity[:TYPE] EVEN ODD ZERO ONE NONE	11-23
SYSTem:COMMunicate:SERial:TRANSmIt:SBITs <numeric_value> ..	11-25
SYSTem:HELP:HEADers?	11-26
SYSTem:LOCAl	11-27
SYSTem:PRESet <character_data>	11-28
Preset Values	11-30

SYSTEM:REMOte.....	11-58
SYSTEM:RINterface GPIB RS232 RS422	11-59
SYSTEM:RWLock	11-60
SYSTEM:VERSion?	11-61
TRACe Subsystem	12-1
TRACe Subsystem	12-2
TRACe[1] 2[:DATA]? <character_data>	12-3
TRACe[1] 2:STATe <boolean>	12-5
TRACe[1] 2:UNIT <character_data>	12-6
TRIGger Subsystem.....	13-1
TRIGger Subsystem	13-2
ABORT[1] 2]	13-3
INITiate Commands	13-4
INITiate[1] 2:CONTInuous <boolean>	13-5
INITiate[1] 2[:IMMEDIATE]	13-7
INITiate:CONTInuous:ALL <boolean>	13-8
INITiate:CONTInuous:SEQuence[1] 2 <boolean>	13-9
INITiate[:IMMEDIATE]:ALL	13-11
INITiate[:IMMEDIATE]:SEQuence[1] 2	13-12
TRIGger Commands	13-13
TRIGger[1] 2:DELay:AUTO <boolean>	13-14
TRIGger[1] 2[:IMMEDIATE]	13-16
TRIGger[1] 2:SOURce BUS EXTernal HOLD IMMEDIATE INTernal[[1] 2]	13-17
TRIGger[:SEQuence]:DELay <numeric_value>	13-19
TRIGger[:SEQuence]:HOLDoff <numeric_value>	13-21
TRIGger[:SEQuence]:HYSTERESIS <numeric_value>	13-23
TRIGger[:SEQuence]:LEVel <numeric_value>	13-25
TRIGger[:SEQuence]:LEVel:AUTO <boolean>	13-27
TRIGger[:SEQuence]:SLOPe <character_data>	13-29
TRIGger[:SEQuence[1] 2]:COUNT <numeric_value>	13-31
TRIGger[:SEQuence[1] 2]:DELay:AUTO <boolean>	13-33
TRIGger[:SEQuence[1] 2]:IMMEDIATE	13-35
TRIGger[:SEQuence[1] 2]:SOURce BUS EXTernal HOLD IMMEDIATE INTernal[[1] 2]	13-36
UNIT Subsystem	14-1
UNIT Subsystem	14-2
UNIT[1] 2 3 4:POWer <amplitude_unit>	14-3
UNIT[1] 2 3 4:POWer:RATio <ratio_unit>	14-6

SERvice Subsystem	15-1
SERvice Subsystem	15-2
SERvice:BIST:CALibrator <boolean>.....	15-3
SERvice:BIST:FPATH[1]2:MEASure?	15-4
SERvice:BIST:FPATH[1]2:REFerence <numeric_value>	15-5
SERvice:BIST:FPATH[1]2:STATe <boolean>	15-6
SERvice:BIST:TBASe:STATe <boolean>	15-7
SERvice:BIST:TRIGger:LEVel:STATe	15-8
SERvice:BIST:TRIGger:TEST?.....	15-9
SERvice:OPTion <character_data>	15-10
SERvice:SENSor[1]2:CALFactor <cal_factor_data>	15-11
SERvice:SENSor[1]2:CDATe?	15-13
SERvice:SENSor[1]2:CORRections:STATe <boolean>	15-14
SERvice:SENSor[1]2:CPLace?	15-16
SERvice:SENSor[1]2:FREQuency:MAXimum?	15-17
SERvice:SENSor[1]2:FREQuency:MINimum?	15-18
SERvice:SENSor[1]2:PCALfactor <cal_factor_data>	15-19
SERvice:SENSor[1]2:POWER:AVERage:MAXimum?	15-20
SERvice:SENSor[1]2:POWER:PEAK:MAXimum?	15-21
SERvice:SENSor[1]2:POWER:USABLE:MAXimum?	15-22
SERvice:SENSor[1]2:POWER:USABLE:MINimum?	15-23
SERvice:SENSor[1]2:RADc?	15-24
SERvice:SENSor[1]2:SNUMber?	15-25
SERvice:SENSor[1]2:TNUMber?	15-26
SERvice:SENSor[1]2:TYPE?	15-27
SERvice:SNUMber <character_data>	15-28
SERvice:VERSion:PROcESSor <character_data>	15-29
SERvice:VERSion:SYSTem <character_data>	15-30
IEEE488.2 Command Reference	16-1
IEEE-488 Compliance Information	16-2
Universal Commands	16-3
DCL	16-3
GET	16-3
GTL	16-3
LLO	16-3
PPC	16-4
PPD	16-4
PPE	16-4
PPU	16-5
SDC.....	16-5
SPD.....	16-5
SPE.....	16-5

*CLS	16-6
*DDT <arbitrary block program data> <string program data>	16-7
*ESE <NRf>	16-9
*ESR?	16-10
*IDN?	16-11
*OPC	16-12
*OPT?	16-13
*RCL <NRf>	16-14
*RST	16-15
*SAV <NRf>	16-16
*SRE <NRf>	16-17
*STB?	16-19
*TRG	16-21
*TST?	16-22
*WAI	16-23
Calibration Factor Block Layout	A-1
Calibration Factor Block Layout.....	A-2
Index	Index-1

THIS PAGE HAS BEEN INTENTIONALLY LEFT BLANK.

List of Tables

	Page
0-1	MEASure? and CONFigure Preset States 1-8
0-2	Range of Values for Window Limits..... 1-64
0-3	Bit Definitions - Status Byte Register 1-84
0-4	Bit Definitions - Standard Event Register 1-86
0-5	Measurement Units 3-18
0-6	Measurement Units 3-20
0-7	Measurement Units 5-10
0-8	Measurement Units 5-12
0-9	Measurement Units 5-17
0-10	Measurement Units 5-19
0-11	Measurement Units 5-28
0-12	Measurement Units 5-30
0-13	Measurement Units 9-57
0-14	Measurement Units 9-59
0-15	Commands and events affecting Status Registers 10-2
0-1	DEfault: Power Meter Presets 11-30
0-2	GSM900: Power Meter Presets 11-34
0-3	GSM900: Power Meter Presets: Window/Measurement Settings..... 11-35
0-4	GSM900: Power Meter Presets For Secondary Channel Sensors 11-36
0-5	EDGE: Power Meter Presets 11-38
0-6	EDGE: Power Meter Presets: Window/Measurement Settings..... 11-39
0-7	EDGE: Power Meter Presets For Secondary Channel Sensors 11-39
0-8	NADC: Power Meter Presets..... 11-40
0-9	NADC: Power Meter Presets: Window/Measurement Settings 11-42
0-10	NADC: Power Meter Presets For Secondary Channel Sensors 11-42
0-11	BLUetooth: Power Meter Presets 11-44
0-12	BLUetooth: Power Meter Presets: Window/Measurement Settings 11-45
0-13	BLUetooth: Power Meter Presets For Secondary Channel Sensors..... 11-45
0-14	CDMAone: Power Meter Presets 11-46
0-15	CDMAone: Power Meter Presets: Window/Measurement Settings..... 11-47
0-16	CDMAone: Power Meter Presets For Secondary Channel Sensors 11-48
0-17	WCDMA: Power Meter Presets 11-49
0-18	WCDMA: Power Meter Presets: Window/Measurement Settings..... 11-50
0-19	WCDMA: Power Meter Presets For Secondary Channel Sensors 11-51
0-20	CDMA2000: Power Meter Presets 11-52
0-21	CDMA2000: Power Meter Presets: Window/Measurement Settings .. 11-53

0-22	CDMA2000: Power Meter Presets For Secondary Channel Sensors ...	11-54
0-23	iDEN: Power Meter Presets	11-55
0-24	iDEN: Power Meter Presets: Window/Measurement Settings	11-56
0-25	iDEN: Power Meter Presets For Secondary Channel Sensors	11-57
0-26	PPD Mapping	16-4
0-27	PPE Mapping	16-4
0-28	*ESE Mapping	16-9
0-29	*ESR? Mapping	16-10
0-30	*SRE Mapping.....	16-17
0-31	*STB? Mapping	16-19

List of Figures

		Page
0-1	Sensor Calibration Tables.....	1-41
0-2	Frequency Dependent Offset Tables	1-51
0-3	Averaged Readings.....	1-59
0-4	Averaging Range Hysteresis	1-59
0-5	Limits Checking Application.....	1-63
0-6	Limits Checking Results.....	1-64
0-7	Pulsed Signal	1-67
0-8	How Measurements are Calculated	1-74
0-9	Generalized Status Register Model	1-76
0-10	Typical Status Register Bit Changes	1-77
0-11	Status System.....	1-83
0-12	CALCulate Block	3-2
0-13	Averaged Readings.....	9-8
0-1	A Trace Display Of The Active Timeslots	11-40

THIS PAGE HAS BEEN INTENTIONALLY LEFT BLANK.

1

———— **Power Meter Remote Operation**

Introduction

This chapter describes the parameters which configure the power meter and help you determine settings to optimize performance. It contains the following sections:

- “Configuring the Remote Interface”, on page 1-3.
- “Zeroing and Calibrating the Power Meter”, on page 1-5.
- “Making Measurements”, on page 1-8.
- “Making Measurements on Wireless Communication Standards”, on page 1-24
- “Using Sensor Calibration Tables”, on page 1-40.
- “Using Frequency Dependent Offset Tables”, on page 1-50
- “Setting the Range, Resolution and Averaging”, on page 1-57.
- “Setting Offsets”, on page 1-61.
- “Setting Measurement Limits”, on page 1-63.
- “Measuring Pulsed Signals”, on page 1-67.
- “END”, on page 1-69.
- “Getting the Best Speed Performance”, on page 1-70.
- “How Measurements are Calculated”, on page 1-74.
- “Status Reporting”, on page 1-75.
- “Saving and Recalling Power Meter Configurations”, on page 1-95.
- “Using Device Clear to Halt Measurements”, on page 1-96.
- “An Introduction to the SCPI Language”, on page 1-97.
- “Summary Of Commands”, on page 1-106.
- “SCPI Compliance Information”, on page 1-119.

Configuring the Remote Interface

This section describes how to configure the GPIB, RS232 and RS422 remote interfaces.

Interface election

You can choose to control the power meter remotely using either the GPIB, RS232 or RS422 standard interfaces.

For information on selecting the remote interface manually from the front panel, refer to the *EPM-P Series Power Meters User's Guide*.

To select the interface remotely use the:

- `SYSTEM:RINTerface` command

To query the current remote interface selection use the:

- `SYSTEM:RINTerface?` command

GPIB Address

Each device on the GPIB (IEEE-488) interface must have a unique address. You can set the power meter's address to any value between 0 and 30. The address is set to 13 when the power meter is shipped from the factory.

The address is stored in non-volatile memory, and does not change when the power meter is switched off, or after a remote interface reset.

Your GPIB bus controller has its own address. Avoid using the bus controller's address for any instrument on the interface bus. Hewlett-Packard controllers generally use address 21.

For information on setting the GPIB address manually from the front panel, refer to the *EPM-P Series Power Meters User's Guide*.

To set the GPIB address from the remote interface use the:

- `SYSTEM:COMMunicate:GPIB:ADDRESS` command.

To query the GPIB address from the remote interface use the;

- `SYSTEM:COMMunicate:GPIB:ADDRESS?` query.

RS232/RS422 Configuration

The RS232/RS422 serial port on the rear panel is a nine pin D-type connector configured as a DTE (Data Terminal Equipment). For pin-out information and cable length restrictions refer to the *EPM-P Series Power Meters User's Guide*.

You can set the baud rate, word length, parity, number of stop bits, software and hardware pacing, either remotely or from the front panel. For front panel operation refer to the *EPM-P Series Power Meter User's Guide*. For remote operation use the following commands:

```
SYSTEM:COMMunicate:SERial:CONTRol:DTR  
SYSTEM:COMMunicate:SERial:CONTRol:RTS  
SYSTEM:COMMunicate:SERial[:RECeive]:BAUD  
SYSTEM:COMMunicate:SERial[:RECeive]:BITs  
SYSTEM:COMMunicate:SERial[:RECeive]:PACE  
SYSTEM:COMMunicate:SERial[:RECeive]:PARity[:TYPE]  
SYSTEM:COMMunicate:SERial[:RECeive]:SBITs  
SYSTEM:COMMunicate:SERial:TRANsmiT:AUTO?  
SYSTEM:COMMunicate:SERial:TRANsmiT:BAUD  
SYSTEM:COMMunicate:SERial:TRANsmiT:BITs  
SYSTEM:COMMunicate:SERial:TRANsmiT:ECHO  
SYSTEM:COMMunicate:SERial:TRANsmiT:PACE  
SYSTEM:COMMunicate:SERial:TRANsmiT:PARity[:TYPE]  
SYSTEM:COMMunicate:SERial:TRANsmiT:SBITs
```

Zeroing and Calibrating the Power Meter

This section describes how to zero and calibrate the power meter.

The calibration and zeroing commands are overlapped commands refer to “Using the Operation Complete Commands”, on page 1-93 to determine when the commands are complete.

Zeroing

Zeroing adjusts the power meter’s specified channel for a zero power reading with no power applied to the power sensor.

The command used to zero the power meter is:

```
CALibration[1|2]:ZERO:AUTO ONCE
```

The command assumes that there is no power being applied to the sensor. It turns the power reference oscillator off, then after zeroing, returns the power reference oscillator to the same state it was in prior to the command being received.

When to Zero?

Zeroing of the power meter is recommended:

- when a 5⁰C change in temperature occurs.
- when you change the power sensor.
- every 24 hours.
- prior to measuring low level signals. For example, 10 dB above the lowest specified power for your power sensor.

Calibration

Calibration sets the gain of the power meter using a 50 MHz 1 mW calibrator as a traceable power reference. The power meter’s POWER REF output or a suitable external reference is used as the signal source for calibration. An essential part of calibrating is setting the correct reference calibration factor for the power sensor you are using. The 8480 Series power sensors and N8480 Series power sensors with Option CFT require you to set the reference calibration factor. All E-Series power sensors and N8480 Series power sensors (excluding Option CFT) set the reference calibration factor automatically. Offset, relative and duty cycle settings are ignored during calibration.

Power Meter Remote Operation

Zeroing and Calibrating the Power Meter

The command used to calibrate the power meter is:

```
CALibration[1|2]:AUTO ONCE
```

The command assumes that the power sensor is connected to a 1 mW reference signal. It turns the power reference oscillator on, then after calibrating, returns the power reference oscillator to the same state it was in prior to the command being received. It is recommended that you zero the power meter before calibrating.

Calibration Sequence

This feature allows you to perform a complete calibration sequence with a single query. The query is:

```
CALibration[1|2][:ALL]?
```

The query assumes that the power sensor is connected to the power reference oscillator. It turns the power reference oscillator on, then after calibrating, returns the power reference oscillator to the same state it was in prior to the command being received. The calibration sequence consists of:

- Zeroing the power meter (`CALibration[1|2]:ZERO:AUTO ONCE`), and
- calibrating the power meter (`CALibration[1|2]:AUTO ONCE`).

The query enters a number into the output buffer when the sequence is complete. If the result is 0 the sequence was successful. If the result is 1 the sequence failed. Refer to `CALibration[1|2][:ALL]?` on page 4-5 for further information.

Note

The `CALibration[1|2][:ALL]` command is identical to the `CALibration[1|2][:ALL]?` query except that no number is returned to indicate the outcome of the sequence. You can examine the Questionable Status Register or the error queue to discover if the sequence has passed or failed. Refer to “Status Reporting”, on page 1-75 for further information.

Setting the Reference Calibration Factor

All the 8480 Series power sensors and N8480 Series power sensors with Option CFT require you to set the reference calibration factor. The reference calibration factor can be set by:

- entering the value into the power meter using the `CALibrate[1|2]:RCFactor` command.
- selecting and enabling the sensor calibration table. The reference calibration factor is automatically set by the power meter using the reference calibration factor stored in the sensor calibration table. See “Using Sensor Calibration Tables”, on page 1-40 for further information.

Examples

- a) To enter a reference calibration factor of 98.7% for channel A, you should use the following command:

```
CAL:RCF 98.7PCT
```

This overrides any RCF previously set by selecting a sensor calibration table.

- b) To automatically set the reference calibration factor, you have to use a sensor calibration table as described in “Using Sensor Calibration Tables”, on page 1-40. To select and enable the table use the following commands:

```
[SENSe[1]]|SENSe2:CORRection:CSET1:SElect <string>  
[SENSe[1]]|SENSe2:CORRection:CSET1:STATe ON
```

When the sensor calibration table is selected the RCF from the table overrides any value previously set.

Querying the Reference Calibration Factor

To determine the current reference calibration factor, use the following command:

```
CALibration[1|2]:RCFactor?
```

Making Measurements

The MEASure? and CONFigure commands provide the most straight-forward method to program the power meter for measurements. You can select the measurement's expected power level, resolution and with the E4417A the measurement type (that is single channel, difference or ratio measurements) all in one command. The power meter automatically presets other measurement parameters to default values as shown in Table 0-1.

Table 0-1: MEASure? and CONFigure Preset States

Command	MEASure? and CONFigure Setting
Trigger source (TRIGger : SOURce)	Immediate
Filter (SENSe : AVERAge : COUNT : AUTO)	On
Filter state (SENSe : AVERAge : STATE)	On
Trigger cycle (INITiate : CONTinuous)	Off
Trigger Delay (TRIGger : DELay : AUTO)	On

An alternative method to program the power meter is to use the lower level commands. The advantage of using the lower level commands over the CONFigure command is that they give you more precise control of the power meter. As shown in Table 0-1 the CONFigure command presets various states in the power meter. It may be likely that you do not want to preset these states. Refer to "Using the Lower Level Commands", on page 1-23 for further information.

Using MEASure?

The simplest way to program the power meter for measurements is by using the MEASure? query. However, this command does not offer much flexibility. When you execute the command, the power meter selects the best settings for the requested configuration and immediately performs the measurement. You cannot change any settings (other than the expected power value, resolution and with the E4417A the measurement type) before the measurement is taken. This means you cannot fine tune the measurement, for example, you cannot change the filter length. To make more flexible and accurate measurements use the CONFIGure command. The measurement results are sent to the output buffer. MEASure? is a compound command which is equivalent to an ABORT, followed by a CONFIGure, followed by a READ?.

MEASure? Examples

The following commands show a few examples of how to use the MEASure? query to make a measurement. It is advisable to read through these examples in order as they become increasingly more detailed. These examples configure the power meter for a measurement (as described in each individual example), automatically place the power meter in the “wait-for-trigger” state, internally trigger the power meter to take one reading, and then sends the reading to the output buffer.

These examples give an overview of the MEASure? query. For further information on the MEASure? commands refer to the section “Running H/F 2” starting on page 2-49.

Example 1 - The Simplest Method

The following commands show the simplest method of making single channel (for example A or B) measurements. Using MEAS1? will result in an upper window measurement, and MEAS2? in a lower window measurement. The channel associated with the window can be set using the source list parameter (see example 2), or will default as in this example (See also page 1-12).

specifies window
↓
MEAS1?
MEAS2?

Example 4 - Specifying the Resolution Parameter

The previous examples detailed the use of the expected value and source list parameters. The resolution parameter is used to set the resolution of the specified window. This parameter does not affect the resolution of the GPIB data, however it does affect the auto averaging setting (refer to Figure 0-3 on page 1-59).

Since the filter length used for a channel with auto-averaging enabled is dependent on the window resolution setting, a conflict arises when a given channel is set up in both windows and the resolution settings are different. In this case, the higher resolution setting is used to determine the filter length.

The following example uses the resolution parameter to specify a resolution setting of 3. This setting represents 3 significant digits if the measurement suffix is W or %, and 0.01 dB if the suffix is dB or dBm. Refer to Chapter 2, “Measurement Commands” for further details on the resolution parameter. The expected power and source list parameters are defaulted in the example. The expected power value will be left unchanged at its current setting. The source list parameter will be defaulted as described in the note on page 1-12. Note that as the source list parameter is the last specified parameter you do not have to specify DEF. The measurement is carried out on the upper window.

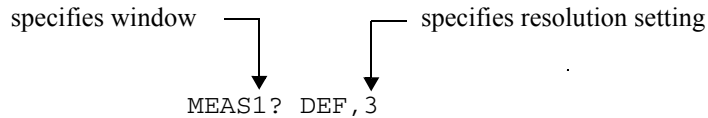

Example 5 - Making a Difference Measurement

The following command can only be carried out on the HP EPM-442A. It queries the lower window to make a difference measurement of channel B - channel A. The expected power and resolution parameters are defaulted, leaving them at their current settings.

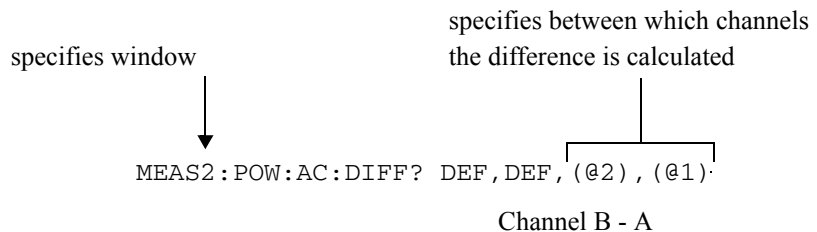

Example 6 - Making a Ratio Measurement

The following command can only be carried out on the E4417A. It queries the upper window to make a ratio measurement of channel A/B. The expected power and resolution parameters are defaulted, leaving them at their current settings.

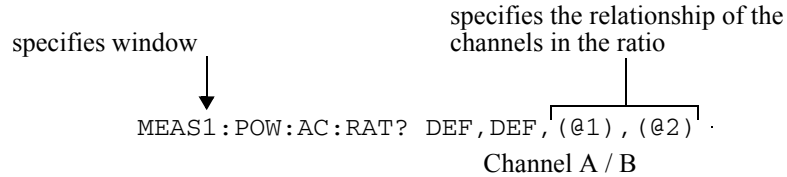

Note E4417A only.

The operation of the MEASure? command when the source list parameter is defaulted depends on the current setup of the window concerned (for example, A, B, A/B, A-B etc.) and on the particular command used (for example, MEAS [: POW] [: AC] ? and MEAS : POW : AC : RAT?).

This means that when the source list parameter is defaulted, there are a number of possibilities.

Command	Current Window Setup	Measurement
MEAS1 [: POW] [AC] ?	Upper Window: A B Any Other	A B A
MEAS2 [: POW] [AC] ?	Lower Window: A B Any Other	A B B
MEAS1 : POW : AC : RAT	Upper Window: A/B B/A Any Other	A/B B/A A/B
MEAS2 : POW : AC : RAT	Lower Window: A/B	A/B

Command	Current Window Setup	Measurement
	B/A Any Other	B/A A/B
MEAS1 : POW : AC : DIFF?	Upper Window: A-B B-A Any Other	A-B B-A A-B
MEAS2 : POW : AC : DIFF?	Lower Window: A-B B-A Any Other	A-B B-A A-B

Using the CONFigure Command

When you execute this command, the power meter presets the best settings for the requested configuration (like the MEASure? query). However, the measurement is not automatically started and you can change measurement parameters before making measurements. This allows you to incrementally change the power meter's configuration from the preset conditions. The power meter offers a variety of low-level commands in the SENSE, CALCulate, and TRIGger subsystems. For example, if you want to change the averaging use the [SENSE[1]] | SENSE2: AVERage: COUNT command.

Use the INITiate or READ? query to initiate the measurement.

Using READ?

CONFigure does not take the measurement. One method of obtaining a result is to use the READ? query. The READ? query takes the measurement using the parameters set by the CONFigure command then sends the reading to the output buffer. Using the READ? query will obtain new data.

Using INITiate and FETCh?

CONFigure does not take the measurement. One method of obtaining the result is to use the INITiate and FETCh? commands. The INITiate command causes the measurement to be taken. The FETCh? query retrieves a reading when the measurement is complete, and sends the reading to the output buffer. FETCh? can be used to display the measurement results in a number of different formats (for example, A/B and B/A) without taking fresh data for each measurement.

CONFigure Examples

The following program segments show how to use the READ? command and the INITiate and FETCh? commands with CONFigure to make measurements.

It is advisable to read through these examples in order as they become increasingly more detailed.

These examples give an overview of the CONFigure command. For further information on the CONFigure commands refer to Chapter 2, "Measurement Commands".

Example 1 - The Simplest Method

The following program segments show the simplest method of querying the upper and lower window's measurement results respectively.

Using READ?

```
*RST      Reset instrument
CONF1     Configure upper window - defaults to a channel A
           measurement
READ1?    Take upper window (channel A) measurement

*RST      Reset instrument
CONF2     Configure the lower window - defaults to channel A      (E4416A),
           Channel B (E4417A) measurement
READ2?    Take lower window measurement (channel A on
           E4416A, B on E4417A)
```

Using INITiate and FETCh?

```
*RST      Reset instrument
CONF1     Configure upper window - defaults to a channel A
           measurement
INIT1     Causes channel A to make a measurement
FETC1?    Retrieves the upper window's measurement
```

For the E4416A only:

```
*RST      Reset instrument
CONF2     Configure lower window - E4416A defaults to
           channel A
INIT1?    Causes channel A to make measurement
FETC2?    Retrieves the lower window's measurement
```

For the E4417A only:

```
*RST      Reset instrument
CONF2     Configure lower window
INIT2?    Causes channel B to make measurement
FETC2?    Retrieves the lower window's measurement
```

Example 2 - Specifying the Source List Parameter

The `CONFigure` and `READ?` commands have three optional parameters, an expected power value, a resolution and a source list. These parameters must be entered in the specified order. If parameters are omitted, they will default from the right. The parameter `DEFault` is used as a place holder.

The following examples use the source list parameter to specify the measurement channel as channel A. The expected power and resolution parameters are defaulted, leaving them at their current settings. The measurement is carried out on the upper window.

Although the `READ?` and `FETCH?` queries have three optional parameters it is not necessary to define them as shown in these examples. If they are defined they must be identical to those defined in the `CONFigure` command otherwise an error occurs.

Note

For the HP EPM-441A it is not necessary to specify a channel as only one channel is available.

Using `READ?`

<code>ABOR1</code>	<i>Aborts channel A</i>
<code>CONF1 DEF, DEF, (@1)</code>	<i>Configures the upper window to make a channel A measurement using the current expected power and resolution settings.</i>
<code>READ1?</code>	<i>Takes the upper window's measurement.</i>

Using `INITiate` and `FETCH?`

<code>ABOR1</code>	<i>Aborts channel A</i>
<code>CONF1 DEF, DEF, (@1)</code>	<i>Configures the upper window to make a channel A measurement using the current expected power and resolution settings.</i>
<code>INIT1</code>	<i>Causes channel A to make a measurement.</i>
<code>FETC1?</code>	<i>Retrieves the upper window's measurement.</i>

Example 3 - Specifying the Expected Power Parameter

The previous example details the three optional parameters which can be used with the `CONFigure` and `READ?` commands. The first optional parameter is used to enter an expected power value. Entering this parameter is only relevant if you are using an E-Series power sensor or N8480 Series power sensor (excluding Option CFT). The value entered determines which of the power sensor's two ranges is used for the measurement. If the current setting of the power sensor's range is no longer valid for the new measurement, specifying the expected power value decreases the time taken to obtain a result.

The following example uses the expected value parameter to specify a value of -50 dBm. This selects the power meter's lower range (refer to "Range", on page 1-57 for details of the range breaks). The resolution parameter is defaulted, leaving it at its current setting. The source list parameter specifies a channel B measurement. The measurement is carried out on the upper window.

Using `READ?`

<code>ABOR2</code>	<i>Aborts channel B</i>
<code>CONF1 -50, DEF, (@2)</code>	<i>Configures the upper window to make a channel B measurement using an expected power of -50 dBm and the current resolution setting.</i>
<code>READ1?</code>	<i>Takes the upper window's measurement.</i>

Some fine tuning of measurements can be carried out using the `CONFigure` and `READ?` commands. For example, in the above program segment some fine tuning can be carried out by setting the filter length to 1024 and the trigger delay off.

```
ABOR2
CONF1 -50, DEF, (@2)
SENS2: AVER: COUN 1024
TRIG2: DEL: AUTO OFF
READ1?
```

Using `INITiate` and `FETCh?`

<code>ABOR2</code>	<i>Aborts channel B</i>
--------------------	-------------------------

Power Meter Remote Operation Making Measurements

CONF1 -50,DEF, (@2)	<i>Configures the upper window to make a channel B measurement using an expected power of -50 dBm and the current resolution setting.</i>
INIT2	<i>Causes channel B to make a measurement.</i>
FETC1?	<i>Retrieves the upper window's measurement.</i>

Some fine tuning of measurements can be carried out using the CONFigure command and INITiate and FETCh? commands. For example, in the above program segment some fine tuning can be carried out by setting the filter length to 1024 and the trigger delay off.

```
ABOR2
CONF1 -50,DEF, (@2)
SENS2:AVER:COUN 1024
TRIG2:DEL:AUTO OFF
INIT2
FETC1?
```

Example 4 - Specifying the Resolution Parameter

The previous examples detailed the use of the expected value and source list parameters. The resolution parameter is used to set the resolution of the specified window. This parameter does not affect the resolution of the GPIB data, however it does affect the auto averaging setting (refer to Figure 0-3 on page 1-59).

Since the filter length used for a channel with auto-averaging enabled is dependent on the window resolution setting, a conflict arises when a given channel is set up in both windows and the resolution settings are different. In this case, the higher resolution setting is used to determine the filter length.

The following example uses the resolution parameter to specify a resolution setting of 3. This setting represents 3 significant digits if the measurement suffix is W or %, and 0.01 dB if the suffix is dB or dBm (for further details on the resolution parameter refer to the commands in Chapter 2, “Measurement Commands”). Also, in this example the expected power and source list parameters are defaulted. The expected power value will be left unchanged at its current setting. The source list parameter will be defaulted as described in the note on page 1-12. Note that as the source list parameter is the last specified parameter you do not have to specify DEF.

Using READ?

ABOR1	<i>Aborts channel A.</i>
CONF1 DEF, 3	<i>Configures the upper window to make a measurement using the current setting of the expected power and source list and a resolution setting of 3.</i>
READ1?	<i>Takes the upper window's measurement. This will be a channel A or B measurement depending on current window setup</i>

Some fine tuning of the above program segment can be carried out for example, by setting the trigger delay off. The following program segment assumes that channel A is currently being measured on the upper window.

```
ABOR1
CONF1 DEF, 3
TRIG1:DEL:AUTO OFF
READ1?
```

Using INITiate and FETCh?

Power Meter Remote Operation Making Measurements

The following program segment assumes that channel A is currently being measured on the upper window.

ABOR1	<i>Aborts channel A.</i>
CONF1 DEF, 3	<i>Configures the upper window to make a measurement using the current setting of the expected power and source list and a resolution setting of 3.</i>
INIT1	<i>Causes channel A to make a measurement.</i>
FETC1?	<i>Retrieves the upper window's measurement.</i>

Some fine tuning of the above program segment can be carried out for example, by setting the trigger delay off.

```
ABOR1
CONF1 DEF, 3
TRIG1:DEL:AUTO OFF
INIT1:IMM
FETC1?
```

Example 5 - Making a Difference Measurement

The following program segment can be carried out on the HP EPM-442A. It queries the lower window to make a difference measurement of channel A - channel B. The expected power level and resolution parameters are defaulted, leaving them at their current settings. Some fine tuning of the measurement is carried out by setting the averaging, and the trigger delay to off.

Using READ?

```
ABOR1
ABOR2
CONF2:POW:AC:DIFF DEF,DEF,(@1),(@2)
SENS1:AVER:COUN 1024
SENS2:AVER:COUN 1024
TRIG1:DEL:AUTO OFF
TRIG2:DEL:AUTO OFF
READ2:POW:AC:DIFF?
READ2:POW:AC:DIFF? DEF,DEF,(@2),(@1) (A second READ? query is sent
to make a channel B - channel A measurement using fresh measurement data.)
```

Using INITiate and FETCh?

```
ABOR1
ABOR2
CONF2:POW:AC:DIFF DEF,DEF,(@1),(@2)
SENS1:AVER:COUN 1024
SENS2:AVER:COUN 1024
TRIG1:DEL:AUTO OFF
TRIG2:DEL:AUTO OFF
INIT1:IMM
INIT2:IMM
FETC2:POW:AC:DIFF?
FETC2:POW:AC:DIFF? DEF,DEF,(@2),(@1) (A second FETCh? query is
sent to make a channel B - channel A measurement using the current measurement
data.)
```

Example 6 - Making a Ratio Measurement

The following program segment can be carried out on the HP EPM-442A. It queries the lower window to make a ratio measurement of channel A/B. The expected power level and resolution parameters are defaulted, leaving them at their current settings. Some fine tuning of the measurement is carried out by setting the averaging.

Using READ?

```
ABOR1
ABOR2
CONF2:POW:AC:RAT DEF,DEF, (@1) , (@2)
SENS1:AVER:COUN 512
SENS2:AVER:COUN 256
READ2:POW:AC:RAT?
READ2:POW:AC:RAT? DEF,DEF, (@2) , (@1) (A second READ? query is sent
to make a channel B - channel A ratio measurement using fresh measurement data.)
```

Using INITiate and FETCh?

```
ABOR1
ABOR2
CONF2:POW:AC:RAT DEF,DEF, (@1) , (@2)
SENS1:AVER:COUN 512
SENS2:AVER:COUN 256
INIT1:IMM
INIT2:IMM
FETC2:POW:AC:RAT?
FETC2:POW:AC:RAT? DEF,DEF, (@2) , (@1) (A second FETCh? query is sent
to make a channel B - channel A measurement using the current measurement data.)
```

Using the Lower Level Commands

An alternative method of making measurements is to use the lower level commands to set up the expected range and resolution. This can be done using the following commands:

```
[SENSE[1]] | SENSE2:POWER:AC:RANGE
DISPlay[:WINDow[1|2]]:RESolution
```

The measurement type can be set using the following commands in the CALCulate subsystem:

```
CALCulate[1|2]:MATH[:EXPRession]
CALCulate[1|2]:RELative[:MAGNitude]
```

The advantage of using the lower level commands over the CONFIGure command is that they give you more precise control of the power meter. As shown in Table 0-1 on page 1-8 the CONFIGure command presets various states in the power meter. It may be likely that you do not want to preset these states.

Example

The following example sets the expected power value to -50 dBm and the resolution setting to 3 using the lower level commands. The measurement is a single channel A measurement carried out on the lower window.

ABOR1	<i>Aborts channel A.</i>
CALC2:MATH:EXPR "(SENS1)"	<i>Displays channel A on lower window.</i>
SENS1:POW:AC:RANG 0	<i>Sets lower range (E-Series sensors and N8480 Series sensors (excluding Option CFT) only).</i>
DISP:WIND2:RES 3	<i>Sets the lower window's resolution to setting 3.</i>
INIT1	<i>Causes channel A to make a measurement.</i>
FETC2?	<i>Retrieves the lower window's measurement.</i>

Making Measurements on Wireless Communication Standards

The following sections describe typical measurements you may want to make. They are also described, for front panel operation, in the User's Guide.

Measuring GSM

The following shows you how to measure the average power in a GSM RF burst. Triggering is achieved using the rising edge of the burst. The 'useful' part of the GSM burst lasts for 542.8 μ s with a rise time of 28 μ s. As the power meter triggers during the rising power transition, the measurement gate is configured to measure the average power in a 520 μ s period, 20 μ s after triggering. The trigger is configured for the a power level of -20 dBm on a rising edge. A trigger hold off is also setup for 4275 μ s, disabling the trigger for 7.5 GSM time slots, ensuring the same time slot is measured at the next GSM frame. The single numeric window is configured to display the average power in gate 1. The trace window is configured to show the RF burst from 20 μ s ahead of the trigger for a duration of 700 μ s.

Note

The E9321A and E9325A sensors are best suited as they have the optimum dynamic range and low-level stability in the 300 kHz bandwidth.

*CLS	<i>Clears error queue</i>
*RST	<i>Resets meter settings to their default states</i>
:SYST:ERR? <read string>	<i>The system error query should return "0: No Error"</i>
SERV:SENS:TYPE?	<i>The sensor type query should return one of the following: E9321A E9322A E9323A E9325A E9326A E9327A</i>
	<i>The GSM setup is only valid with these sensors</i>
SENS:FREQ:900MHZ	<i>Sets the measurement frequency to 900 MHz</i>
SENS:BW:VID:HIGH	<i>Only send this command if using an E9321A or E9325A</i>

<code>SENS:BW:VID:LOW</code>	<i>Only send this command if using an E9323A or E9327A</i>
<code>SENS:SWE1:OFFS:TIME:0.00002</code>	<i>Sets gate1 start point to 20 μs after the trigger</i>
<code>SENS:SWE1:TIME0.00052</code>	<i>Sets gate1 length to 520 μs</i>
<code>INIT:CONT ON</code>	<i>Puts meter in "wait for trigger" state</i>
<code>TRIG:SOUR INT</code>	<i>Selects internal trigger</i>
<code>TRIG:LEV:AUTO OFF</code>	<i>Turn off auto leveling for trigger</i>
<code>TRIG:LEV -20.00DBM</code>	<i>Sets trigger level to -20.0 dBm</i>
<code>TRIG:DEL 0.00002</code>	<i>Actual trigger to occur 20 μs after trig level detected</i>
<code>TRIG:HOLD 0.004275</code>	<i>Sets trigger hold-off to 4.275 ms</i>
<code>DISP:WIND1:TRACE:LOW -35</code>	<i>Sets trace display minimum power to -35 dBm</i>
<code>DISP:WIND1:TRACE:UPP 20</code>	<i>Sets trace display maximum power to +20 dBm</i>
<code>SENS:TRAC:OFFS:TIME -0.00004</code>	<i>Trace starts 40 μs before trigger point</i>
<code>SENS:TRAC:TIME 0.0007</code>	<i>Trace span set to 700 μs</i>
<code>DISP:WIND1:FORM TRACE</code>	<i>Assigns upper window to a trace display</i>
<code>DISP:WIND2:FORM SNUM</code>	<i>Assigns lower window to a single numeric display</i>
<code>CALC2:FEED1 "POW:AVER ON SWEEP1"</code>	<i>Lower window to show average power using timing defined by gate1</i>

Measuring EDGE

Enhanced Data for Global Evolution or Enhanced Data for GSM Evolution is an enhancement of the GSM standard. The modulation scheme is 8PSK. As Edge does not have constant amplitude GMSK modulation like GSM, peak-to-average ratio may be of interest.

The following procedure shows you how to measure the average power in a GSM RF burst. Triggering is achieved using the rising edge of the burst. The 'useful' part of the GSM burst lasts for 542.8 μ s with a rise time of 28 μ s. Also, trigger hysteresis is

included to prevent small power transitions during the burst causing re-triggering. As the power meter triggers during the rising power transition, the measurement gate is configured to measure the average power in a 520 μ s period, 20 μ s after triggering. The display is configured to show the peak and peak-to-average results in the lower window in numeric format while the upper window shows the power trace starting 40 μ s before the trigger.

Note

The E9321A and E9325A sensors are best suited as they have the optimum dynamic range and low-level stability in the 300 kHz bandwidth.

*CLS	<i>Clears error queue</i>
*RST	<i>Resets meter settings to their default states</i>
:SYST:ERR? <read string>	<i>The system error query should return "0: No Error"</i>
SERV:SENS:TYPE?	<i>The sensor type query should return one of the following: E9321A E9322A E9323A E9325A E9326A E9327A</i>
	<i>The EDGE setup is only valid with these sensors</i>
SENS:FREQ:900MHZ	<i>Sets the measurement frequency to 900 MHz</i>
SENS:BW:VID:HIGH	<i>Only send this command if using an E9321A or E9325A</i>
SENS:BW:VID:LOW	<i>Only send this command if using an E9323A or E9327A</i>
SENS:SWE1:OFFS:TIME:0.00002	<i>Sets gate1 start point to 20 μs after the trigger</i>
SENS:SWE1:TIME0.00052	<i>Sets gate1 length to 520 μs</i>
INIT:CONT ON	<i>Puts meter in "wait for trigger" state</i>
TRIG:SOUR INT	<i>Selects internal trigger</i>
TRIG:LEV:AUTO OFF	<i>Turn off auto leveling for trigger</i>
TRIG:LEV -20.00DBM	<i>Sets trigger level to -20.0 dBm</i>

TRIG:DEL 0.00002	<i>Actual trigger to occur 20 μs after trig level detected</i>
TRIG:HOLD 0.004275	<i>Sets trigger hold-off to 4.275 ms</i>
TRIG:HYST 3.0	<i>Sets Hysteresis to 3 dB</i>
DISP:WIND1:TRACE:LOW -55	<i>Sets trace display minimum power to -55 dBm</i>
DISP:WIND1:TRACE:UPP 20	<i>Sets trace display maximum power to +20 dBm</i>
SENS:TRAC:OFFS:TIME -0.00004	<i>Trace starts 40 μs before trigger point</i>
SENS:TRAC:TIME 0.0007	<i>Trace span set to 700 μs</i>
DISP:WIND1:FORM TRACE	<i>Assigns upper window to a trace display</i>
DISP:WIND2:FORM DNUM	<i>Assigns lower window to a dual numeric display</i>
CALC2:FEED1 "POW:AVER ON SWEEP1"	<i>Lower window upper display line to show average power using timing defined by gate1</i>
CALC4:FEED1 "POW:PTAV ON SWEEP1"	<i>Lower window lower display line to show peak-to-average ratio using timing defined by gate1</i>

Measuring NADC

The following procedure shows you how to measure the average power of both active time slots in NADC or IS-136 'full rate' transmission. This assumes that there are two time slots in each frame to be measured, for example, time slots 0.

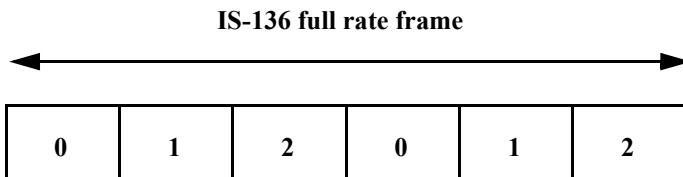

Triggering is achieved using the rising edge of the burst. The measurement gates are configured to measure the average power in two NADC time slots, separated by two inactive time slots. The rise time of an NADC TDMA burst is approximately 123.5 μ s

Power Meter Remote Operation
Making Measurements on Wireless Communication Standards

(6bits) and the ‘useful’ part of the burst lasts approximately 6.4 ms. Gate 1 is configured to measure the average power in a 6.4ms period, 123.5 μ s after triggering. Gate 2 is configured to measure the average power in a 6.4ms period, 20.123 ms (3 time slots plus rise times) after triggering.

The display is configured to show the Gate 1 and Gate 2 average results in the lower window in numeric format, while the upper window shows the power trace starting 2 ms before the trigger.

Note

The narrow bandwidth of the NADC signal requires only the 30 kHz bandwidth of the E9321A and E9325A sensors in the Low setting and these are best suited. Other E9320 sensors may be used in their lowest setting but they provide less dynamic range and low-level stability.

*CLS	<i>Clears error queue</i>
*RST	<i>Resets meter settings to their default states</i>
:SYST:ERR? <read string>	<i>The system error query should return “0: No Error”</i>
SERV:SENS:TYPE?	<i>The sensor type query should return one of the following: E9321A E9322A E9323A E9325A E9326A E9327A</i>
	<i>The NADC setup is only valid with these sensors</i>
SENS:FREQ:800MHZ	<i>Sets the measurement frequency to 800 MHz</i>
SENS:BW:VID:LOW	<i>Select low video bandwidth</i>
SENS:SWE1:OFFS:TIME:0.0001235	<i>Sets gate1 start point to 123.5 μs after the trigger</i>
SENS:SWE1:TIME0.0064	<i>Sets gate1 length to 6.4 ms</i>
SENS:SWE2:OFFS:TIME:0.020123	<i>Sets gate2 start point to 20.123 ms after the trigger</i>
SENS:SWE2:TIME0.0064	<i>Sets gate2 length to 6.4 ms</i>
INIT:CONT ON	<i>Puts meter in “wait for trigger” state</i>
TRIG:SOUR INT	<i>Selects internal trigger</i>

TRIG:LEV:AUTO OFF	<i>Turn off auto leveling for trigger</i>
TRIG:LEV -20.00DBM	<i>Sets trigger level to -20.0 dBm</i>
TRIG:HOLD 0.03	<i>Sets trigger hold-off to 30 ms</i>
DISP:WIND1:TRACE:LOW -35	<i>Sets trace display minimum power to -35 dBm</i>
DISP:WIND1:TRACE:UPP 20	<i>Sets trace display maximum power to +20 dBm</i>
SENS:TRAC:OFFS:TIME -0.0002	<i>Trace starts 200 μs before trigger point</i>
SENS:TRAC:TIME 0.028	<i>Trace span set to 28 ms</i>
DISP:WIND1:FORM TRACE	<i>Assigns upper window to a trace display</i>
DISP:WIND2:FORM DNUM	<i>Assigns lower window to a dual numeric display</i>
CALC2:FEED1 "POW:AVER ON SWEEP1"	<i>Lower window upper display line to show average power using timing defined by gate1</i>
CALC4:FEED1 "POW:PTAV ON SWEEP2"	<i>Lower window lower display line to show peak-to-average ratio using timing defined by gate2</i>

Measuring iDEN

The following procedure shows you how to measure the average power, the peak-to-average power ratio in one iDEN training and data pulse, and the average power in a 90 ms iDEN frame. Triggering is achieved using the rising edge of the training burst. The trigger is configured for a power level of -30 dBm on a rising edge. Auto-level triggering may also be used. A trigger hold off is also set up to ensure the power meter is not re-triggered by the data pulse following the training pulse. Time gating is used to measure the average power in the following 15 ms pulse. The display is configured to show the peak-to-average ratio within the data pulse and the average power in the entire 90 ms frame on two display lines in the lower window while the upper window shows the average power in a 15 ms data pulse. All displays are numeric.

Note

The narrow bandwidth of the iDEN signal requires only the 30 kHz bandwidth of the E9321A and E9325A sensors in the Low setting and these are best suited. Other E9320 sensors may be used in their lowest setting but they provide less dynamic range and low-level stability.

*CLS	<i>Clears error queue</i>
*RST	<i>Resets meter settings to their default states</i>
:SYST:ERR? <read string>	<i>The system error query should return "0: No Error"</i>
SERV:SENS:TYPE?	<i>The sensor type query should return one of the following: E9321A E9322A E9323A E9325A E9326A E9327A</i>
	<i>The iDEN setup is only valid with these sensors</i>
SENS:FREQ:800MHZ	<i>Sets the measurement frequency to 800 MHz</i>
SENS:BW:VID:LOW	<i>Select low video bandwidth</i>
SENS:SWE1:OFFS:TIME:0.00001	<i>Sets gate1 start point to 10 μs after the trigger</i>
SENS:SWE1:TIME:0.015	<i>Sets gate1 length to 15 ms</i>
SENS:SWE2:TIME:0.090	<i>Sets gate2 length to 90 ms</i>

INIT:CONT ON	<i>Puts meter in “wait for trigger” state</i>
TRIG:SOUR INT	<i>Selects internal trigger</i>
TRIG:LEV:AUTO OFF	<i>Turn off auto leveling for trigger</i>
TRIG:LEV -20.00DBM	<i>Sets trigger level to -20.0 dBm</i>
TRIG:HOLD 0.02	<i>Sets trigger hold-off to 20 ms</i>
DISP:WIND1:FORM SNUM	<i>Assigns upper window to a single numeric display</i>
DISP:WIND2:FORM DNUM	<i>Assigns lower window to a dual numeric display</i>
CALC1:FEED1 “POW:AVER ON SWEEP1”	<i>Upper window to show average power using timing defined by gate1</i>
CALC2:FEED1 “POW:PTAV ON SWEEP1”	<i>Lower window upper display line to show peak-to-average ratio using timing defined by gate1</i>
CALC4:FEED1 “POW:PTAV ON SWEEP2”	<i>Lower window lower display line to show peak power ratio using timing defined by gate2</i>

Measuring Bluetooth

The following procedure shows you how to measure the peak and average power in a single Bluetooth DH1 data burst. Triggering is achieved using the rising edge of the burst. The trigger is configured for a power level of -20 dBm on a rising edge. A trigger hold off is also setup for 650 μ s, disabling the trigger until the current time slot is measured. The measurement gate is configured to measure the peak and average power in a 366 μ s period, 0.2 μ s after the trigger. The display is configured to show the peak and average power in the lower window in numeric format, while the upper window shows the power trace over 6 time slots starting 50 μ s before the trigger.

Note

The E9321A and E9325A sensors are best suited. The E9321A and E9325A are not recommended due to lack of bandwidth.

*CLS	<i>Clears error queue</i>
*RST	<i>Resets meter settings to their default states</i>
:SYST:ERR? <read string>	<i>The system error query should return "0: No Error"</i>
SERV:SENS:TYPE?	<i>The sensor type query should return one of the following: E9322A E9323A E9326A E9327A</i>
	<i>The Bluetooth setup is only valid with these sensors</i>
SENS:FREQ:2400MHZ	<i>Sets the measurement frequency to 2400 MHz</i>
SENS:BW:VID:HIGH	<i>Only send this command if using an E9322A or E9326A</i>
SENS:SWE1:OFFS:TIME:0.0000002	<i>Sets gate1 start point to 200 ns after the trigger</i>
SENS:SWE1:TIME0.000366	<i>Sets gate1 length to 366 μs</i>
INIT:CONT ON	<i>Puts meter in "wait for trigger" state</i>
TRIG:SOUR INT	<i>Selects internal trigger</i>
TRIG:LEV:AUTO OFF	<i>Turn off auto leveling for trigger</i>
TRIG:LEV -20.00DBM	<i>Sets trigger level to -20.0 dBm</i>

TRIG:HOLD 0.00065	<i>Sets trigger hold-off to 4650 μs</i>
TRIG:HYST 3.0	<i>Sets Hysteresis to 3 dB</i>
DISP:WIND1:TRACE:LOW -35	<i>Sets trace display minimum power to -35 dBm</i>
DISP:WIND1:TRACE:UPP 20	<i>Sets trace display maximum power to +20 dBm</i>
SENS:TRAC:OFFS:TIME -0.00001	<i>Trace starts 10 μs before trigger point</i>
SENS:TRAC:TIME 0.00065	<i>Trace span set to 650 μs</i>
DISP:WIND1:FORM TRACE	<i>Assigns upper window to a trace display</i>
DISP:WIND2:FORM DNUM	<i>Assigns lower window to a dual numeric display</i>
CALC2:FEED1 "POW:AVER ON SWEEP1"	<i>Lower window upper display line to show average power using timing defined by gate1</i>
CALC4:FEED1 "POW:PEAK ON SWEEP1"	<i>Lower window lower display line to show peak power using timing defined by gate1</i>

Measuring cdmaOne

The following procedure shows you how to make a continuous measurement on a cdmaOne signal. Peak and peak-to-average power measurements are made over a defined and statistically valid number of samples. With gated 10 ms measurements, corresponding to 200,000 samples, there is less than a 0.01% probability that there are no peaks above the measured peak value. The trigger is configured for continuous triggering on a rising edge at -10 dBm. This results in continuously updated results based on a 10 ms period relating to a position beyond 0.01% on the CCDF curve, responding to any changes in signal or DUT.

Note

The E9322A and E9326A sensors are best suited due to their 1.5 MHz bandwidth. The E9321A and E9325A are not recommended due to their lack of bandwidth.

*CLS	<i>Clears error queue</i>
*RST	<i>Resets meter settings to their default states</i>
:SYST:ERR? <read string>	<i>The system error query should return "0: No Error"</i>
SERV:SENS:TYPE?	<i>The sensor type query should return one of the following: E9322A E9323A E9326A E9327A</i>
	<i>The cdmaOne setup is only valid with these sensors</i>
SENS:FREQ:850MHZ	<i>Sets the measurement frequency to 850 MHz</i>
SENS:BW:VID:HIGH	<i>Only send this command if using an E9322A or an E9326A</i>
SENS:SWE1:OFFS:TIME:0	<i>Sets gate1 start point to the trigger point</i>
SENS:SWE1:TIME 10E-3	<i>Sets gate time to 10 ms</i>
INIT:CONT ON	<i>Puts meter in "wait for trigger" state</i>
TRIG:SOUR INT	<i>Selects internal trigger</i>
TRIG:LEV:AUTO OFF	<i>Turn off auto leveling for trigger</i>

TRIG:LEV -10.00DBM	<i>Sets trigger level to -10.0 dBm</i>
DISP:WIND1:FORM SNUM	<i>Assigns upper window to a single numeric display</i>
DISP:WIND2:FORM DNUM	<i>Assigns lower window to a dual numeric display</i>
CALC1:FEED1 "POW:AVER"	<i>Upper window to show average power</i>
CALC2:FEED1 "POW:PEAK"	<i>Lower window upper display line to show peak power</i>
CALC4:FEED1 "POW:PTAV"	<i>Lower window lower display line to show peak-to-average ratio</i>

Measuring W-CDMA

The following procedure shows you how to make a continuous measurement on a W-CDMA signal. Peak and peak-to-average power measurements are made over a defined and statistically valid number of samples. With gated 10 ms measurements, corresponding to 200,000 samples, there is less than a 0.01% probability that there are no peaks above the measured peak value. The trigger is configured for continuous triggering on a rising edge at -10 dBm. This results in continuously updated results based on a 10 ms period relating to a position beyond 0.01% on the CCDF curve, responding to any changes in signal or DUT.

Note

The E9323A and E9327A sensors are best suited due to their 5 MHz bandwidth. The E9321A, E9322A, E9325A, and E9326A sensors are not recommended due to their lack of bandwidth (5 MHz required).

*CLS	<i>Clears error queue</i>
*RST	<i>Resets meter settings to their default states</i>
:SYST:ERR? <read string>	<i>The system error query should return "0: No Error"</i>
SERV:SENS:TYPE?	<i>The sensor type query should return one of the following: E9323A E9327A</i>
	<i>The W-CDMA setup is only valid with these sensors</i>
SENS:FREQ:1900MHZ	<i>Sets the measurement frequency to 1900 MHz</i>
SENS:BW:VID:HIGH	<i>Sets the sensor bandwidth to high</i>
SENS:SWE1:OFFS:TIME:0	<i>Sets gate1 start point to the trigger point</i>
SENS:SWE1:TIME 10E-3	<i>Sets gate time to 10 ms</i>
INIT:CONT ON	<i>Puts meter in "wait for trigger" state</i>
TRIG:SOUR INT	<i>Selects internal trigger</i>
TRIG:LEV:AUTO OFF	<i>Turn off auto leveling for trigger</i>
TRIG:LEV -10.00DBM	<i>Sets trigger level to -10.0 dBm</i>

DISP:WIND1:FORM SNUM	<i>Assigns upper window to a single numeric display</i>
DISP:WIND2:FORM DNUM	<i>Assigns lower window to a dual numeric display</i>
CALC1:FEED1 "POW:AVER"	<i>Upper window to show average power</i>
CALC2:FEED1 "POW:PEAK"	<i>Lower window upper display line to show peak power</i>
CALC4:FEED1 "POW:PTAV"	<i>Lower window lower display line to show peak-to-average ratio</i>

Measuring cdma2000

The following procedure shows you how to make a continuous measurement on a cdma2000 signal. Peak and peak-to-average power measurements are made over a defined and statistically valid number of samples. With gated 10 ms measurements, corresponding to 200,000 samples, there is less than a 0.01% probability that there are no peaks above the measured peak value. The trigger is configured for continuous triggering on a rising edge at -10 dBm. This results in continuously updated results based on a 10 ms period relating to a position beyond 0.01% on the CCDF curve, responding to any changes in signal or DUT.

Note

The E9323A and E9327A sensors are best suited due to their 5 MHz bandwidth. The E9321A, E9322A, E9325A, and E9326A sensors are not recommended due to their lack of bandwidth (5 MHz required).

*CLS	<i>Clears error queue</i>
*RST	<i>Resets meter settings to their default states</i>
:SYST:ERR? <read string>	<i>The system error query should return "0: No Error"</i>
SERV:SENS:TYPE?	<i>The sensor type query should return one of the following: E9323A E9327A</i>
	<i>The cdma2000 setup is only valid with these sensors</i>
SENS:FREQ:1900MHZ	<i>Sets the measurement frequency to 1900 MHz</i>
SENS:BW:VID:HIGH	<i>Sets the sensor bandwidth to high</i>
SENS:SWE1:OFFS:TIME:0E-6	<i>Sets gate1 start point to the trigger point</i>
SENS:SWE1:TIME 10E-3	<i>Sets gate time to 10 ms</i>
INIT:CONT ON	<i>Puts meter in "wait for trigger" state</i>
TRIG:SOUR INT	<i>Selects internal trigger</i>
TRIG:LEV:AUTO OFF	<i>Turn off auto leveling for trigger</i>
TRIG:LEV -10.00DBM	<i>Sets trigger level to -10.0 dBm</i>

DISP:WIND1:FORM SNUM	<i>Assigns upper window to a single numeric display</i>
DISP:WIND2:FORM DNUM	<i>Assigns lower window to a dual numeric display</i>
CALC1:FEED1 "POW:AVER"	<i>Upper window to show average power</i>
CALC2:FEED1 "POW:PEAK"	<i>Lower window upper display line to show peak power</i>
CALC4:FEED1 "POW:PTAV"	<i>Lower window lower display line to show peak-to-average ratio</i>

Using Sensor Calibration Tables

This section applies to all 8480 Series power sensors and N8480 Series power sensors with Option CFT. It does not apply to the E-Series power sensors and N8480 Series power sensors (excluding Option CFT). All E-Series power sensors have their sensor calibration tables stored in EEPROM which allows frequency and calibration factor data to be downloaded by the power meter automatically.

This section describes how to use sensor calibration tables. Sensor calibration tables are used to store the measurement calibration factors, supplied with each power sensor, in the power meter. These calibration factors are used to correct measurement results.

Overview

For the 8480 Series power sensors and N8480 Series power sensors with Option CFT, there are two methods of providing correction data to the power meter depending on the setting of the `[SENSE[1]] | SENSE2:CORREction:CSET1:STATE` command. If `[SENSE[1]] | SENSE2:CORREction:CSET1:STATE` is OFF the sensor calibration tables are not used. To make a calibrated power measurement when `[SENSE[1]] | SENSE2:CORREction:CSET1:STATE` is OFF, perform the following steps:

1. Zero and calibrate the power meter. Before carrying out the calibration set the reference calibration factor for the power meter you are using.
2. Set the calibration factor to the value for the frequency of the signal you want to measure.
3. Make the measurement.

When `[SENSE[1]] | SENSE2:CORREction:CSET1:STATE` is ON, the sensor calibration tables are used, providing you with a quick and convenient method for making power measurements at a range of frequencies using one or more power sensors. Note that with the sensor calibration table selected, the RCF from the table overrides any value previously set. The power meter is capable of storing 20 sensor calibration tables of 80 frequency points each.

Figure 0-1 illustrates how sensor calibration tables operate.

Figure 0-1: Sensor Calibration Tables

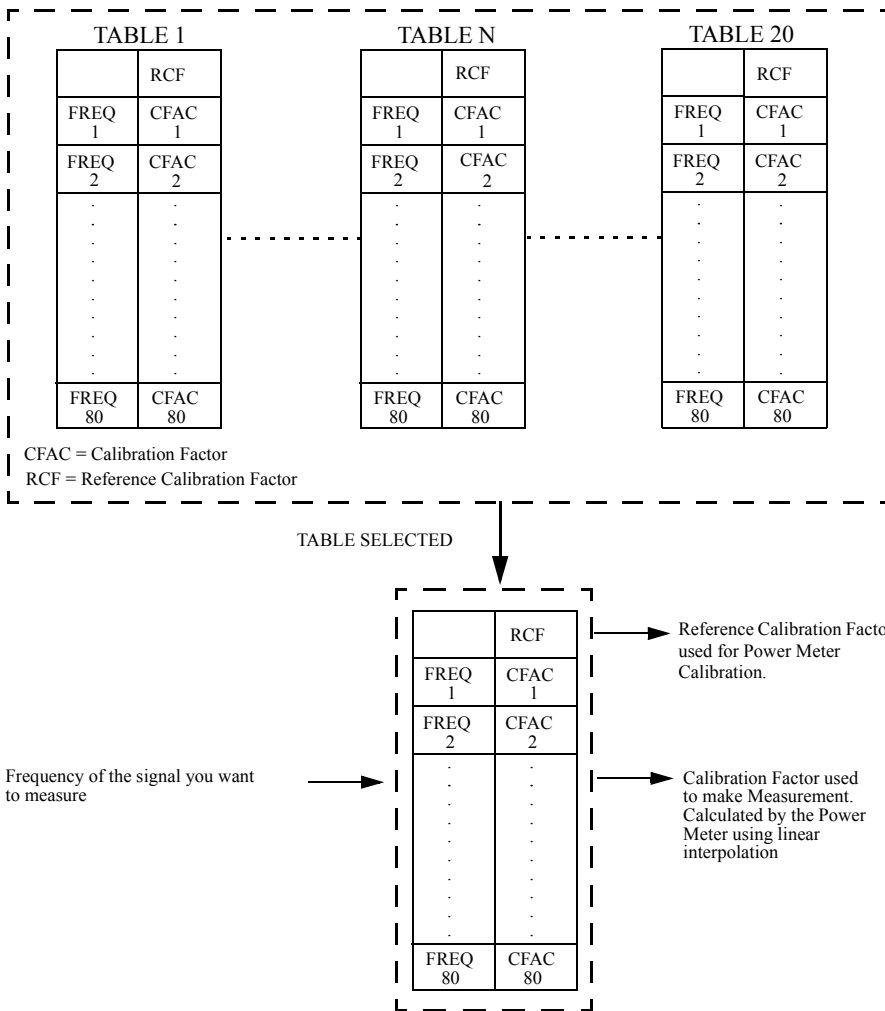

Power Meter Remote Operation Using Sensor Calibration Tables

To use sensor calibration tables you:

1. Edit a sensor calibration table if necessary.
2. Select the sensor calibration table.
3. Enable the sensor calibration table.
4. Zero and calibrate the power meter. The reference calibration factor used during the calibration is automatically set by the power meter from the sensor calibration table.
5. Specify the frequency of the signal you want to measure. The calibration factor is automatically set by the power meter from the sensor calibration table.
6. Make the measurement.

Editing Sensor Calibration Tables

It is not possible to create any additional sensor calibration tables. However, the 20 existing ones can be edited using the MEMory subsystem. To do this:

1. Select one of the existing tables using:
MEMory:TABLE:SElect <string>.
For information on naming sensor calibration tables see “Naming Sensor Calibration Tables”, on page 1-46. For information on the current names which you can select refer to “Listing Sensor Calibration Table Names”, on page 1-44.
2. Enter the frequency data using:
MEMory:TABLE:FREquency <numeric_value>
{, <numeric_value>}
3. Enter the calibration factors using:
MEMory:TABLE:GAIN <numeric_value>
{, <numeric_value>}. The first parameter you enter should be the reference calibration factor, each subsequent parameter is a calibration factor in the sensor calibration table. This means that entries in the frequency list correspond as shown with entries in the calibration factor list.

Frequency	Calibration Factor
	Reference Calibration Factor
Frequency 1	Calibration Factor 1
Frequency 2	Calibration Factor 2
"	"
Frequency n	Calibration Factor n

4. If required, rename the sensor calibration table using:
MEMory:TABLE:MOVE <string>, <string>. The first <string> parameter identifies the existing table name, and the second identifies the new table name.

Note

The legal frequency suffix multipliers are any of the IEEE suffix multipliers, for example, KHZ, MHZ and GHZ. If no units are specified the power meter assumes the data is Hz.

PCT is the only legal unit for calibration factors and can be omitted.

The frequency and calibration data must be within range. Refer to the individual commands in Chapter 4 for their specified ranges.

The number of calibration factor points must be one more than the number of frequency points. This is verified when the sensor calibration table is selected using `[SENSE[1]] | SENSE2:CORREction:CSET1[:SElect] <string>`

Ensure that the frequency points you use cover the frequency range of the signals you want to measure. If you measure a signal with a frequency outside the frequency range defined in the sensor calibration table, then the power meter uses the highest or lowest frequency point in the sensor calibration table to calculate the calibration factor.

To make subsequent editing of a sensor calibration table simpler, it is recommended that you retain a copy of your data in a program.

Listing Sensor Calibration Table Names

To list the tables currently stored in the power meter, use the following command:
`MEMory:CATalog:TABLE?`

Note that all tables are listed, including frequency dependent offset tables.

The power meter returns the data in the form of two numeric parameters and a string list representing all the stored tables.

- `<numeric_value>, <numeric_value>{, <string>}`
The first numeric parameter indicates the amount of memory, in bytes, used for storage of tables. The second parameter indicates the memory, in bytes, available for tables.

Each string parameter returned indicates the name, type and size of a stored sensor calibration table:

- `<string>`, `<type>`, `<size>`
The `<string>`, `<type>` and `<size>` are all character data. The `<type>` is always TABL. The `<size>` is displayed in bytes.

For example, a sample of the response may look like:

```
560,8020,"Sensor_1,TABL,220","Sensor_2,TABL,340" . . . .
```

The power meter is shipped with a set of predefined sensor calibration tables. The data in these sensor calibration tables is based on statistical averages for a range of Agilent Technologies power sensors. These power sensors are:

- DEFAULT¹
- 8481A
- 8482A²
- 8483A
- 8481D
- 8485A
- R8486A
- Q8486A
- R8486D
- 8487A

For further information on naming sensor calibration tables see “Naming Sensor Calibration Tables”, on page 1-46.

Note

Predefined sensor calibration table is not applicable for N8480 Series power sensors with Option CFT. Therefore you are required to create a new sensor calibration table for the sensors when a sensor calibration table is needed.

1. DEFAULT is a sensor calibration table in which the reference calibration factor and calibration factors are 100%. This sensor calibration table can be used during the performance testing of the power meter.

2. The 8482B and 8482H power sensors use the same data as the 8482A.

Naming Sensor Calibration Tables

To rename a sensor calibration table use:

```
MEMory:TABLE:MOVE <string>,<string>
```

The first <string> parameter identifies the existing table name, and the second identifies the new table name.

The following rules apply to sensor calibration table names:

- a) The sensor calibration table must consist of no more than 12 characters.
- b) All characters must be upper or lower case alphabetic characters, or numeric (0-9), or an underscore (_).
- c) No spaces are allowed in the name.

Reviewing Table Data

To review the data stored in a sensor calibration table, use the following commands:

- `MEMory:TABLE:SElect "Sense1"`
Select the sensor calibration table named "Sense1".
- `MEMory:TABLE:SElect?`
Query command which returns the name of the currently selected table.
- `MEMory:TABLE:FREQuency:POINTs?`
Query command which returns the number of stored frequency points.
- `MEMory:TABLE:FREQuency?`
Query command which returns the frequencies stored in the sensor calibration table (in Hz).
- `MEMory:TABLE:GAIN[:MAGNitude]:POINTs?`
Query command which returns the number of calibration factor points stored in the sensor calibration table.
- `MEMory:TABLE:GAIN[:MAGNitude]?`
Query command which returns the calibration factors stored in the sensor calibration table. The first point returned is the reference calibration factor.

Modifying Data

If you need to modify the frequency and calibration factor data stored in a sensor calibration table you need to resend the complete data lists. There are two ways to do this:

1. If you have retained the original data in a program, edit the program and resend the data.
2. Use the query commands shown in "Reviewing Table Data", on page 1-47 to enter the data into your computer. Edit this data, then resend it.

Selecting a Sensor Calibration Table

After you have created the sensor calibration table, you can select it using the following command:

```
[SENSe[1]] | SENSE2:CORRection:CSET1[:SElect] <string>
```

When the table is selected, the power meter verifies the number of calibration factor points defined in the sensor calibration table is one parameter greater than the number of frequency points. If this is not the case an error occurs.

To find out which sensor calibration table is currently selected, use the query:

```
[SENSe[1]] | SENSE2:CORRection:CSET1[:SElect]?
```

Enabling the Sensor Calibration Table System

To enable the sensor calibration table, use the following command:

```
[SENSe[1]] | SENSE2:CORRection:CSET1:STATe ON
```

If you set `[SENSe[1]] | SENSE2:CORRection:CSET1:STATe` to ON and no sensor calibration table is selected error -221, “Settings conflict” occurs.

Making the Measurement

To make the power measurement, set the power meter for the frequency of the signal you want to measure. The power meter automatically sets the calibration factor. Use either the `INITiate`, `FETCh?` or the `READ?` query to initiate the measurement as shown in the following program segments:

INITiate Example

```
ABORt1
CONFigure1:POWer:AC DEF,1,(@1)
SENS1:CORR:CSET1:SEL "HP8481A"
SENS1:CORR:CSET1:STAT ON
SENSe1:FREQuency 500KHZ
INITiate1:IMMediate
FETCh1?
```

READ? Example

```
ABORt1
CONFigure1:POWer:AC DEF,2,(@1)
SENS1:CORR:CSET1:SEL "HP8481A"
SENS1:CORR:CSET1:STAT ON
SENSe1:FREQuency 500KHZ
READ1?
```

Note

If the measurement frequency does not correspond directly to a frequency in the sensor calibration table, the power meter calculates the calibration factor using linear interpolation.

If you enter a frequency outside the frequency range defined in the sensor calibration table, then the power meter uses the highest or lowest frequency point in the sensor calibration table to set the calibration factor.

To find out the value of the calibration factor being used by the power meter to make a measurement, use the query command:

```
[SENSe[1]] | SENSE2:CORRection:CFAC? The response may be an interpolated value.
```

To find out the value of the reference calibration factor being used, use the commands:

```
CALibration[1|2]:RCFactor?
```

Using Frequency Dependent Offset Tables

This section describes how to use frequency dependent offset tables. Frequency dependent offset tables give you the ability to compensate for frequency effects in your test setup.

Overview

If the `[SENSE[1]] | SENSE2:CORREction:CSET2:STATE` command is OFF, the frequency dependent offset tables are not used. When `[SENSE[1]] | SENSE2:CORREction:CSET2:STATE` is ON, the frequency dependent offset tables are used, providing you with a quick and convenient method of compensating for your external test setup over a range of frequencies. Note that when selected, frequency dependent offset correction is IN ADDITION to any correction applied for sensor frequency response. The power meter is capable of storing 10 frequency dependent offset tables of 80 frequency points each.

To use frequency dependent offset tables you:

1. Edit a frequency dependent offset table if necessary.
2. Select the frequency dependent offset table.
3. Enable the frequency dependent offset table.
4. Zero and calibrate the power meter. The reference calibration factor used during the calibration will be automatically set by the power meter from a sensor calibration table, if enabled; otherwise it should be entered manually.
5. Specify the frequency of the signal you want to measure. The required offset is automatically set by the power meter from the frequency dependent offset table.
6. Make the measurement.

Figure 0-2 illustrates how frequency dependent offset tables operate.

Figure 0-2: Frequency Dependent Offset Tables

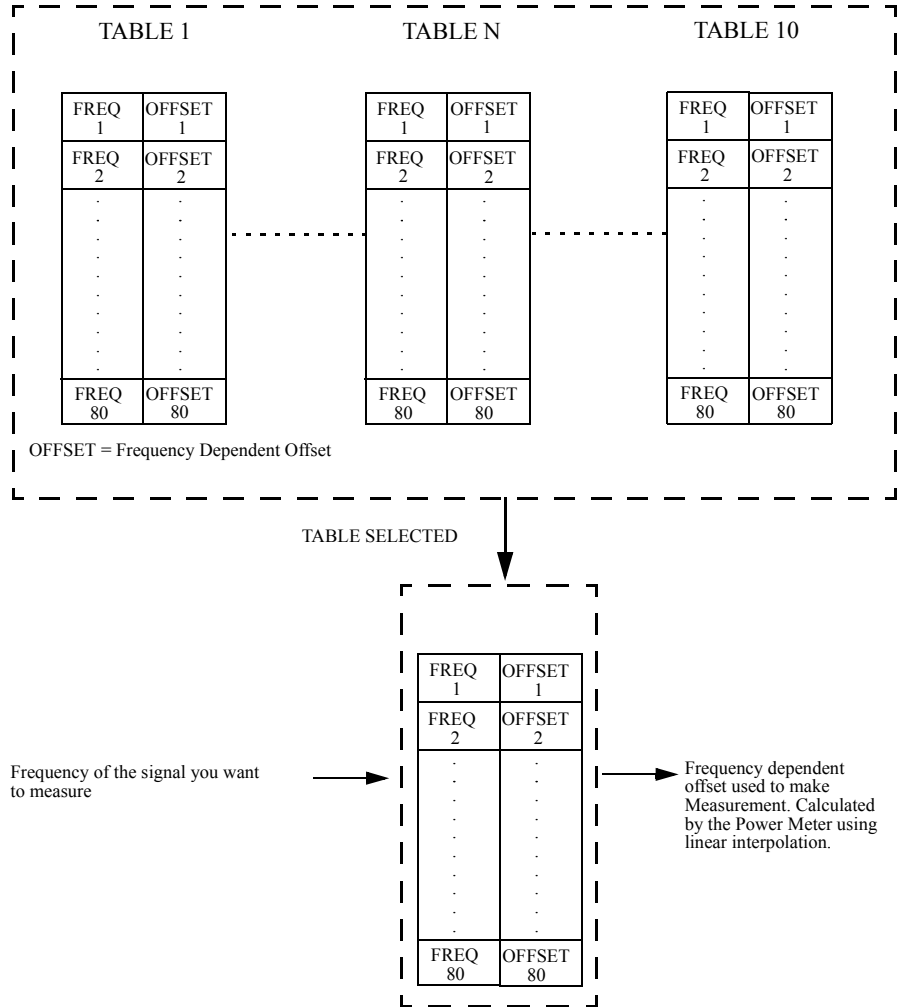

Editing Frequency Dependent Offset Tables

It is not possible to create any additional frequency dependent offset tables. However, the 10 existing ones can be edited using the MEMory subsystem. To do this:

1. Select one of the existing tables using:
`MEMory:TABLE:SElect <string>`.
For information on naming frequency dependent offset tables see “Naming Frequency Dependent Offset Tables”, on page 1-54. For information on the current names which you can select refer to “Listing the Frequency Dependent Offset Table Names”, on page 1-53.
2. Enter the frequency data using:
`MEMory:TABLE:FREquency <numeric_value>
{, <numeric_value>}`
3. Enter the offset factors as shown in the table below using:
`MEMory:TABLE:GAIN <numeric_value>
{, <numeric_value>}`

Frequency	Offset
Frequency 1	Offset 1
Frequency 2	Offset 2
"	"
Frequency n	Offset n

4. If required, rename the frequency dependent offset table using:
`MEMory:TABLE:MOVE <string>, <string>`. The first <string> parameter identifies the existing table name, and the second identifies the new table name.

Note

The legal frequency suffix multipliers are any of the IEEE suffix multipliers, for example, KHZ, MHZ and GHZ. If no units are specified the power meter assumes the data is Hz.

PCT is the only legal unit for offset factors and can be omitted.

The frequency and offset data must be within range. Refer to the individual commands in Chapter 4 for their specified ranges.

Any offset values entered into the table should exclude the effect of the sensor. Characterization of the test setup independently of the sensor allows the same

table to be used with any sensor.

Ensure that the frequency points you use cover the frequency range of the signals you want to measure. If you measure a signal with a frequency outside the frequency range defined in the frequency dependent offset table, then the power meter uses the highest or lowest frequency point in the table to calculate the offset.

To make subsequent editing of a frequency dependent offset table simpler, it is recommended that you retain a copy of your data in a program.

Listing the Frequency Dependent Offset Table Names

To list the frequency dependent offset tables currently stored in the power meter, use the following command:

```
MEMory:CATalog:TABLE?
```

Note that **all** tables are listed; including sensor calibration tables.

The power meter returns the data in the form of two numeric parameters and a string list representing all stored tables.

- `<numeric_value>, <numeric_value>{, <string>}`
The first numeric parameter indicates the amount of memory, in bytes, used for storage of tables. The second parameter indicates the memory, in bytes, available for tables.

Power Meter Remote Operation Using Frequency Dependent Offset Tables

Each string parameter returned indicates the name, type and size of a stored frequency dependent offset table:

- `<string>`, `<type>`, `<size>`
The `<string>`, `<type>` and `<size>` are all character data. The `<type>` is always `TABL`. The `<size>` is displayed in bytes.

For example, a sample of the response may look like:

```
560,8020,"Offset_1,TABL,220","Offset_2,TABL,340" . . . .
```

Naming Frequency Dependent Offset Tables

To rename a frequency dependent offset table use:

```
MEMory:TABLE:MOVE <string>,<string>
```

The first `<string>` parameter identifies the existing table name, and the second identifies the new table name.

The following rules apply to frequency dependent offset table names:

- a) Table names use a maximum of 12 characters.
- b) All characters must be upper or lower case alphabetic characters, or numeric (0-9), or an underscore (`_`).
- c) No spaces are allowed in the name.

Reviewing Table Data

To review the data stored in a frequency dependent offset table, use the following commands:

- `MEMory:TABLE:SElect "Offset1"`
Select the sensor calibration table named "Offset1".
- `MEMory:TABLE:SElect?`
Query command which returns the name of the currently selected table.
- `MEMory:TABLE:FREQuency:POINTs?`
Query command which returns the number of stored frequency points.
- `MEMory:TABLE:FREQuency?`
Query command which returns the frequencies stored in the frequency dependent offset table (in Hz).
- `MEMory:TABLE:GAIN[:MAGNitude]:POINTs?`
Query command which returns the number of offset factor points stored in the frequency dependent offset table.

- `MEMory:TABLE:GAIN[:MAGNitude]?`
Query command which returns the offset factors stored in the frequency dependent offset table.

Modifying Data

If you need to modify the frequency and offset factor data stored in a frequency dependent offset table you need to resend the complete data lists. There are two ways to do this:

1. If you have retained the original data in a program, edit the program and resend the data.
2. Use the query commands shown in “Reviewing Table Data”, on page 1-47 to enter the data into your computer. Edit this data, then resend it.

Selecting a Frequency Dependent Offset Table

After you have created the frequency dependent offset table, you can select it using the following command:

```
[SENSe[1]] | SENSE2:CORRection:CSET2[:SELEct] <string>
```

To find out which frequency dependent offset table is currently selected, use the query:

```
[SENSe[1]] | SENSE2:CORRection:CSET2[:SELEct]?
```

Enabling A Frequency Dependent Offset Table

To enable the frequency dependent offset table, use the following command:

```
[SENSe[1]] | SENSE2:CORRection:CSET2:STATe ON
```

If you set `[SENSe[1]] | SENSE2:CORRection:CSET2:STATe` to ON and no frequency dependent offset table is selected error -221, “Settings conflict” occurs.

Making The Measurement

To make the power measurement, set the power meter for the frequency of the signal you want to measure. The power meter automatically sets the calibration factor. Use either the `INITiate`, `FETCh?` or the `READ?` query to initiate the measurement as shown in the following program segments:

INITiate Example

```
ABORt1  
CONFigure1:POWer:AC DEF,1,(@1)  
SENS1:CORR:CSET2:SEL "Offset1"  
SENS1:CORR:CSET2:STAT ON  
SENSe1:FREQuency 500KHZ  
INITiate1:IMMediate  
FETCh1?
```

READ? Example

```
ABORt1  
CONFigure1:POWer:AC DEF,2,(@1)  
SENS1:CORR:CSET2:SEL "Offset1"  
SENS1:CORR:CSET2:STAT ON  
SENSe1:FREQuency 500KHZ  
READ1?
```

Note

If the measurement frequency does not correspond directly to a frequency in the frequency dependent offset table, the power meter calculates the offset using linear interpolation.

If you enter a frequency outside the frequency range defined in the frequency dependent offset table, then the power meter uses the highest or lowest frequency point in the table to set the offset.

To find out the value of the offset being used by the power meter to make a measurement, use the query command:

```
SENSe:CORRection:GAIN4|FDOFfset[:INPut][MAGNITUDE]? The  
response may be an interpolated value.
```

Setting the Range, Resolution and Averaging

This section provides an overview of setting the range, resolution and averaging. For more detailed information about these features refer to the individual commands in Chapter 9.

Range

The power meter has no internal ranges which can be set. The only ranges that can be set are those of the E-Series power sensors and N8480 Series power sensors (excluding Option CFT). With an E-Series power sensor or N8480 Series power sensor (excluding Option CFT), the range can be set either automatically or manually. Use autoranging when you are not sure of the power level you will be measuring.

Setting the Range

To set the range manually use the following command:

```
[SENSe[1]] | SENSE2:POWER:AC:RANGE <numeric_value>
```

If the <numeric_value> is set to:

- 0, the sensor's lower range is selected. (For example, this range is -70 to -13.5 dBm for the E4412A power sensor.)
- 1, the sensor's upper range is selected. (For example, this range is -14.5 to +20 dBm for the E4412A power sensor.)

For details on the range limits of other E-Series power sensors and N8480 Series power sensors (excluding Option CFT), refer to the appropriate power sensor manual.

For further information on this command refer to page 9-46.

To enable autoranging use the following command:

```
[SENSe[1]] | SENSE2:POWER:AC:RANGE:AUTO ON
```

Use autoranging when you are not sure of the power level you will be measuring.

Resolution

You can set the window's resolution using the following command:

```
DISPlay[:WINDow[1]|2][:NUMeric[1]|2]  
:RESolution <numeric_value>
```

There are four levels of resolution available (1 through 4).

When the measurement suffix is W or % this parameter represents the number of significant digits. When the measurement suffix is dB or dBm, 1 through 4 represents 1, 0.1, 0.01, and 0.001 dB respectively.

For further information refer to the :RESolution command on page 5-21.

Averaging

The power meter has a digital filter to average power readings. The number of readings averaged can range from 1 to 1024. This filter is used to reduce noise, obtain the desired resolution and to reduce the jitter in the measurement results. However, the time to take the measurement is increased. You can select the filter length or you can set the power meter to auto filter mode. To enable and disable averaging use the following command:

```
[SENSe[1]]|SENSe2:AVERage[:STATe] <boolean>
```

Auto Averaging Mode

To enable and disable auto filter mode, use the following command:

```
[SENSe[1]]|SENSe2:AVERage:COUNT:AUTO <boolean>
```

When the auto filter mode is enabled, the power meter automatically sets the number of readings averaged together to satisfy the filtering requirements for most power measurements. The number of readings averaged together depends on the resolution and the power level currently being measured. Figure 0-3 lists the number of readings averaged for each range and resolution when the power meter is in auto filter mode.

Note

Figure 0-3 applies to 8480 Series sensors only.

Figure 0-3: Averaged Readings

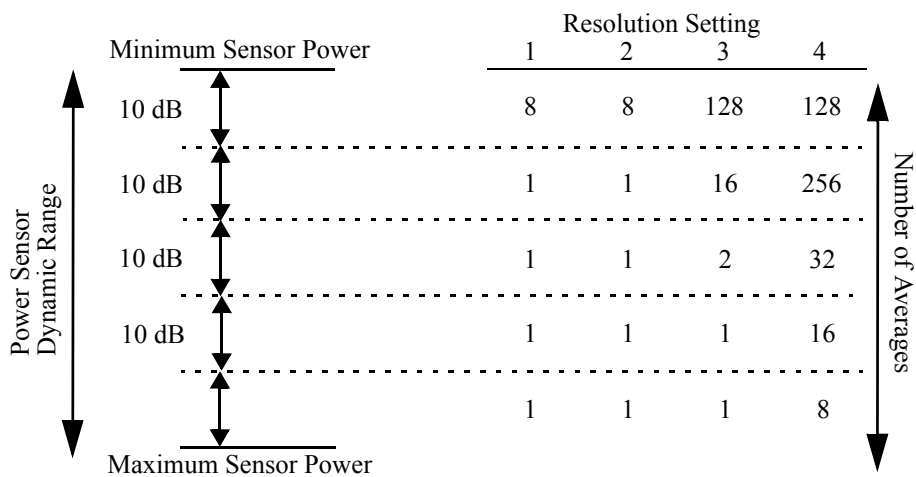
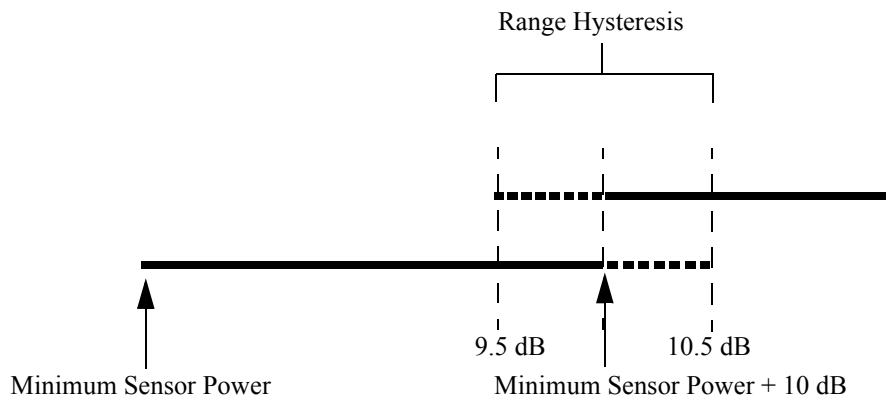

Figure 0-4 illustrates part of the power sensor dynamic range hysteresis.

Figure 0-4: Averaging Range Hysteresis



Filter Length

You specify the filter length using the following command:

```
[SENSe[1]] | SENSE2:AVERAge:COUNT <numeric_value>
```

The range of values for the filter length is 1 to 1024. Specifying this command disables automatic filter length selection. Increasing the value of the filter length reduces measurement noise. However, the time to take the measurement is increased.

Setting Offsets

Channel Offsets

The power meter can be configured to compensate for signal loss or gain in your test setup (for example, to compensate for the loss of a 10 dB attenuator). You use the SENSE command subsystem to configure the power meter. Gain and loss correction are a coupled system. This means that a gain set by

`[SENSE[1]] | SENSE2:CORREction:GAIN2` is represented in the `[SENSE[1]] | SENSE2:CORREction:LOSS2?` command. If you enter an offset value the state is automatically enabled. However it can be enabled and disabled using either the `[SENSE[1]] | SENSE2:CORREction:GAIN2:STATE` or `[SENSE[1]] | SENSE2:CORREction:LOSS2:STATE` commands.

LOSS2 is coupled to GAIN2 by the equation $Loss = \frac{1}{Gain}$ when the default

unit is linear, and $Gain = -Loss$ when the default is logarithmic.

Note

You can only use LOSS2 and GAIN2 for external losses and gains. LOSS1 and GAIN1 are specifically for calibration factors.

Display Offsets

Display offset values can be entered using the

`CALCulate[1|2]:GAIN[:MAGNitude]` command.

`CALCulate[1|2]:GAIN:STATE` must be set to ON to enable the offset value. If you enter an offset value the state is automatically enabled. On the HP EPM-442A this offset is applied after any math calculations (refer to Figure 0-8 on page 1-74).

Example

The following example program, in HP Basic, details how to use the channel and display offsets on an E4417A making a channel A/B ratio measurement. The final result will be:

$$\left(\left(\frac{A_{\text{dBm}} - 10}{B_{\text{dBm}} - 10} \right) - 20 \right)_{\text{dB}}$$

```
10 !Create I/O path name
20 ASSIGN @POWER TO 713
30 !Clear the power meter's interface
40 CLEAR @POWER
50 !Set the power meter to a known state
60 OUTPUT @POWER;"*RST"
70 !Configure the Power Meter to make the measurement
80 OUTPUT @Power;"CONF:POW:AC:RAT 20DBM,2,(@1),(@2)"
90 !Set the measurement units to dBm
100 OUTPUT @POWER;"UNIT:POW DBM"
110 !Set the power meter for channel offsets of -10 dB
120 OUTPUT @POWER;"SENS1:CORR:GAIN2 -10"
130 OUTPUT @POWER;"SENS2:CORR:GAIN2 -10"
140 !Enable the gain correction
150 OUTPUT @POWER;"SENS:CORR:GAIN2:STATe ON"
160 OUTPUT @POWER;"SENS2:CORR:GAIN2:STATe ON"
170 !Set the power meter for a display offset of -20 dB
180 OUTPUT @POWER;"CALC1:GAIN -20 DB"
190 PRINT "MAKING THE MEASUREMENT"
200 !Initiate the measurement
210 OUTPUT @Power;"INIT1:IMM"
220 OUTPUT @Power;"INIT2:IMM"
230 ! ... and get the result
240 OUTPUT @Power;"FETC:POW:AC:RAT? 20DBM,2,(@1),(@2)"
250 ENTER @Power;Reading
260 !
270 PRINT "The measurement result is ";Reading;"dB."
280 END
```

For further information on channel offsets refer to page 9-34. For further information on display offsets refer to page 3-6.

Setting Measurement Limits

You can configure the power meter to detect when a measurement is outside of a predefined upper and/or lower limit value.

Limits are window or measurement display line based and can be applied to power, ratio or difference measurements. In addition, the limits can be set to output a TTL logic level at the rear panel Rmt I/O port when the predefined limits are exceeded.

Setting Limits

The power meter can be configured to verify the power being measured against an upper and/or lower limit value. The range of values that can be set for lower and upper limits is -150.00 dBm to +230.00 dBm. The default upper limit is +90.00 dBm and the default lower limit is -90.00 dBm.

A typical application for this feature is shown in Figure 0-5.

Figure 0-5: Limits Checking Application

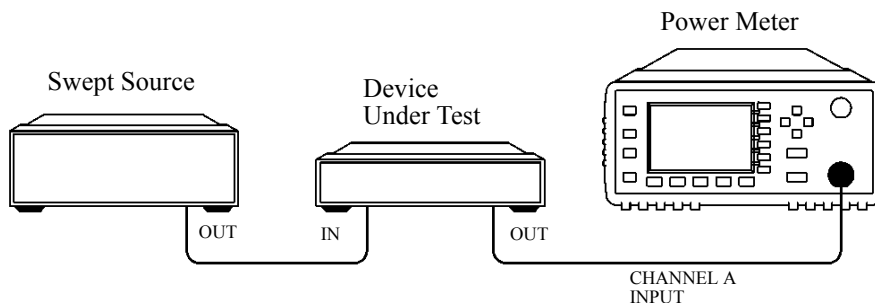
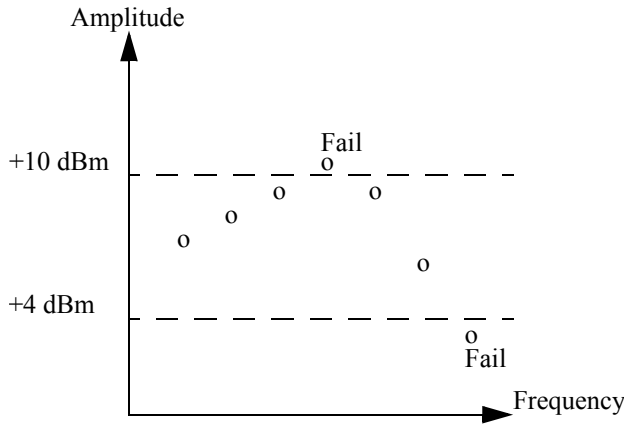

Figure 0-6: Limits Checking Results



Setting Limits

The power meter can be configured to verify the current measurement in any measurement line against predefined upper and/or lower limit values. The range of values that can be set for the upper and lower limits and the default values depends on the measurement units in the currently measurement line - see Table 0-2.

Table 0-2: Range of Values for Window Limits

Window Units	Max	Min	Default	
			Max	Min
dB	+200 dB	-180 dB	60 dB	-120 dB
dBm	+230 dBm	-150 dBm	90 dBm	-90 dBm
%	10.0 Z%	100.0 a%	100.0 M%	100.0 p%
W	100.000 XW	1.000 aW	1.000 MW	1.000 pW

The limits can also be set to output a TTL logic level at the rear panel Rmt I/O port when the predefined limits are exceeded. You can switch the rear panel TTL outputs on or off; set the TTL output level to active high or low; and determine whether the TTL output represents an over limit condition, under limit condition or both. Refer to

Chapter 8 “OUTput Subsystem” for TTL output programming commands and to the *EPM-P Series Power Meters User’s Guide* for connector and pin-out information.

Checking for Limit Failures

There are two ways to check for limit failures:

1. Use the `SENSe:LIMit:FAIL?` and `SENSe:LIMit:FCOunt?` commands for channel limits or the `CALCulate[1|2]:LIMit:FAIL?` and the `CALCulate[1|2]:LIMit:FCOunt?` for window limits.
2. Use the `STATus` command subsystem.

Using SENSE and CALCulate

Using `SENSe` to check the channel limit failures in Figure 0-6 would return the following results:

`SENSe:LIMit:FAIL?`

Returns 1 if there has been 1 or more limit failures or 0 if there have been no limit failures. In this case 1 is returned.

`SENSe:LIMit:FCOunt?`

Returns the total number of limit failures, in this case 2.

Use the equivalent `CALCulate` commands for checking window limit failures.

Note

If `TRIGger:DElay:AUTO` is set to ON, then the number of failures returned by `SENSe:LIMit:FCOunt?` or `CALCulate[1|2]:LIMit:FCOunt?` will be affected by the current filter settings.

Using STATus

You can use the STATus subsystem to generate an SRQ to interrupt your program when a limit failure occurs. This is a more efficient method than using SENSE or CALCulate, since you do not need to check the limit failures after every power measurement.

Refer to “Status Reporting”, on page 1-75 and “STATus Subsystem”, on page 10-2 for further information.

Configuring the TTL Outputs

The TTL Outputs on the rear panel Rmt I/O port can be used to determine when a predefined limit in either, or both, windows has been exceeded.

Example

The following program segment shows how to use TTL output 1 to indicate when a measurement is outside the range -30 dBm to -10 dBm. It is assumed that the measurement has already been set up in the upper window (window 1).

<code>CALC1:LIM:LOW -30</code>	<i>Sets the lower limit for the upper window to -30 dBm.</i>
<code>CALC1:LIM:UPP -10</code>	<i>Sets the upper limit for the upper window to -10 dBm.</i>
<code>CALC1:LIM:STAT ON</code>	<i>Turns the limits on.</i>
<code>OUTP:TTL1:FEED "CALC1:LIM:LOW, CALC1:LIM:UPP"</code>	<i>Specifies that TTL output 1 should be asserted when the upper or lower limit fails on the upper window.</i>
<code>OUTP:TTL1:ACT HIGH</code>	<i>Specifies that TTL output 1 should be active-high.</i>
<code>OUTP:TTL1:STAT ON</code>	<i>Activates TTL output 1</i>

Measuring Pulsed Signals

Note The E-Series E9320 power sensors are best suited for peak and pulse power measurement. However, the E-Series E9300, 8480 or N8480 Series power sensors can be used.
Pulse measurements are not recommended using E-Series E4410 power sensors.

Using Duty Cycle

The following method describes pulse measurement without the use of an E-Series E9320 power sensor. The measurement result is a mathematical representation of the pulse power rather than an actual measurement. The power meter measures the average power of the pulsed input signal and then divides the measurement result by the duty cycle value to obtain the pulse power reading. The allowable range of values is 0.001% to 99.999%. The default is 1.000%. A duty cycle value can be set using the following command:

```
[SENSE[1]] | SENSE2:CORRection:DCYCLe | GAIN3 <numeric_value>
```

Making the Measurement

An example of a pulsed signal is shown in Figure 0-7.

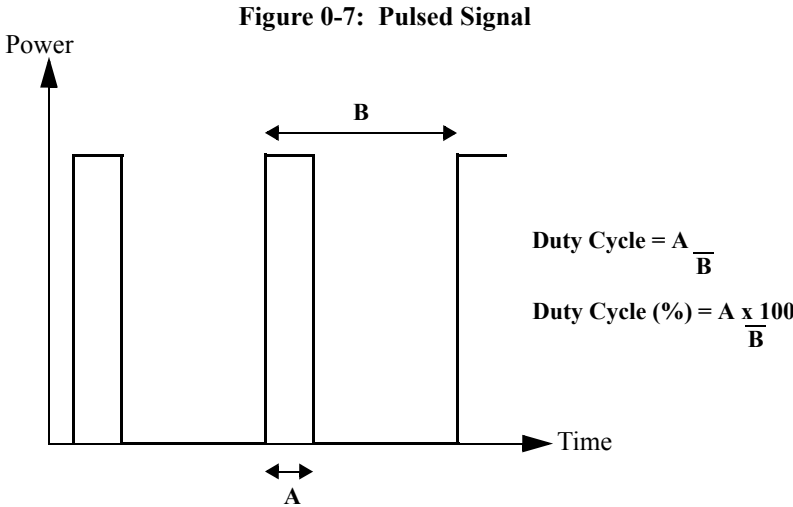

You use the `SENSE` command subsystem to configure the power meter to measure a pulsed signal. The following example program, in HP Basic, shows how to measure the signal for the 8480 Series power sensors and N8480 Series power sensors.

Note

Pulse power averages out any aberrations in the pulse such as overshooting or ringing. For this reason it is called pulse power and not peak power or peak pulse power.

In order to ensure accurate pulse power readings, the input signal must be pulsed with a rectangular pulse. Other pulse shapes (such as triangle, chirp or Gaussian) will cause erroneous results.

The pulse power on/off ratio must be much greater than the duty cycle ratio.

```
10 !Create I/O path name
20 ASSIGN @Power TO 713
30 !Clear the Power Meter's Interface
40 CLEAR @Power
50 !Set the Power Meter to a known state
60 OUTPUT @Power;"*RST"
70 !Configure the Power Meter to make the measurement
80 OUTPUT @Power;"CONF:POW:AC 20DBM,2,(@1)"
90 !Set the reference calibration factor for the sensor
100 OUTPUT @Power;"CAL:RCF 98.7PCT"
110 !Zero and calibrate the power meter
120 OUTPUT @Power;"CAL?"
130 PRINT "ZEROING AND CALIBRATING THE POWER METER"
140 !Verify the outcome
150 ENTER @Power;Success
160 IF Success=0 THEN
170     !Calibration cycle was successful
180     !
190     !Set the measurement units to Watts
200     OUTPUT @Power;"UNIT:POW WATT"
210     !
220     !Set the measurement calibration factor for the
        sensor
230     OUTPUT @Power;"SENS:CORR:CFAC 97.5PCT"
240     !Set the power meter for a duty cycle of 16PCT
250     OUTPUT @Power;"SENS1:CORR:DCYC 16PCT"
260     !
270     !Enable the duty cycle correction
280     OUTPUT @Power;"SENS:CORR:DCYC:STAT ON"
290     PRINT "MAKING THE MEASUREMENT"
300     !Initiate the measurement
310     OUTPUT @Power;"INIT1:IMM"
320     !... and get the result
330     OUTPUT @Power;"FETC?"
340     ENTER @Power;Reading
350     !
360     PRINT "The result is          ";Reading*1000;"mW"
370     !
380 ELSE
390     PRINT "THERE WAS A CALIBRATION ERROR!"
400 END IF
410 PRINT "PROGRAM COMPLETED"
420 END
```

Getting the Best Speed Performance

This section discusses the factors that influence the speed of operation (number of readings/sec) of an EPM-P Series power meter.

The following factors are those which have the greatest effect upon measurement speed (in no particular order):

- The selected measurement rate, i.e. `NORMAL`, `DOUBLE`, `FAST`.
- The sensor being used.
- The trigger mode (for example, free run, trigger with delay etc.).
- The output format: `ASCII` or `REAL`.
- The units used for the measurement.
- The command used to take a measurement.

In addition, in `FAST` mode there are other influences which are described in “Fast Mode”, on page 1-73.

The following paragraphs give a brief description of the above factors and how they are controlled from SCPI.

Measurement Rate

There are three possible speed settings `NORMAL`, `DOUBLE` and `FAST`. These are set using the `SENSE:MRATE` command and can be applied to each channel independently (E4417A only).

In `NORMAL` and `DOUBLE` modes, full instrument functionality is available and these settings can be used with all sensors. `FAST` mode is available only for E-Series sensors and averaging, limits and ratio/difference math functions are disabled.

Refer to “Specifications” in the *EPM-P Series Power Meters User’s Guide* to see the influence of these speed settings on the accuracy and noise performance of the power meter.

Sensor

Different measurement rates are achievable depending on the sensor type being used:

Sensor	Measurement Rate		
	NORMal	DOUBLE	FAST
8480 Series and N8480 Series	50 ms	25 ms	NA
E-Series E4410, E9300	50 ms	25 ms	Up to 400
E-Series E9320, AVERage only mode	50 ms	25 ms	Up to 400
E-Series E9320, NORMal mode	50 ms	25 ms	Up to 1000

Trigger Mode

The power meter has a very flexible triggering system. For simplicity, it can be described as having three modes:

- Free Run: When a channel is in Free Run, it continuously takes measurements on this channel. A channel is in free run when `INITiate:CONTinuous` is set to `ON` and `TRIGger:SOURce` is set to `IMMediate`.
- Triggered Free Run: When a channel is in Triggered Free Run Continuous Trigger, it takes a new measurement each time a trigger even is detected. A channel is in Triggered Free Run Continuous Trigger when `INITiate:CONTinuous` is set to `ON` and `TRIGger:SOURce` is **not** set to `IMMediate`.
- Single Shot: When a channel is in Single Shot, it takes a new measurement when a trigger event is detected and then returns to the idle state. A channel is in Single Shot when `INITiate:CONTinuous` is set to `OFF`. Note that a measurement can take several `INT/EXT` triggers depending on the filter settings. Refer to `TRIGger[1]|2:DELay:AUTO <boolean>` in Chapter 13 for further information.

Note

A trigger event can be any of the following:

- The input signal meeting the trigger level criteria.
- Auto-level triggering being used.

- A TRIGger GET or *TRG command being sent.
 - An external TTL level trigger being detected.
-

Trigger with delay

This can be achieved using the same sequences above (apart from the second) with TRIG:DEL:AUTO set to ON. Also, the MEAS? command operates in trigger with delay mode.

In trigger with delay mode, a measurement is not completed until the power meter filter is full. In this way, the reading returned is guaranteed to be settled. In all other modes, the result returned is simply the current result from the filter and may or may not be settled. This depends on the current length of the filter and the number of readings that have been taken since a change in power level.

With trigger with delay enabled, the measurement speed can be calculated roughly using the following equation:

$$\text{readings/sec} = \text{speed (as set by SENSE:SPEEd)} / \text{filter length}$$

For example, with a filter length of 4 and SENS:SPE set to 20, approximately 5 readings/sec will be calculated by the power meter.

In general, free run mode will provide the best speed performance from the power meter (especially in 200 readings/sec mode).

Output Format

The power meter has two output formats for measurement results: ASCii and REAL. These formats can be selected using the FORMat command. When FORMat is set to REAL, the result returned is in IEEE 754 floating-point format (note that the byte order can be changed using FORMat:BORDER) plus <LF> as an end sentinel of the block.

The REAL format is likely to be required only for FAST mode as a means to reduce bus traffic.

Units

The power meter can output results in either linear or log units. The internal units are linear and therefore optimal performance will be achieved when the results output are also in linear units (since the overhead of performing a log function is removed).

Command Used

In Free Run mode, `FETCh?` must be used to return a result.

In other trigger modes, there are a number of commands which can be used, for example, `MEASure?`, `READ?`, `FETCh?` Note that the `MEAS?` and `READ?` commands are compound commands—they perform a combination of other lower level commands. In general, the best speed performance is achieved using the low level commands directly.

Trigger Count

To get the fastest measurement speed the a `TRIG:COUNT` must be set to return multiple measurements for each `FETCh` command. For average only measurements a count of 4 is required but 10 is recommended. In normal mode (peak measurements) a count of 50 is required to attain 1000 readings per second.

Fast Mode

In the highest speed setting, the limiting factor tends to be the speed of the controller being used to retrieve results from the power meter, and to a certain extent, the volume of GPIB traffic. The latter can be reduced using the `FORMat REAL` command to return results in binary format. The former is a combination of two factors:

- the hardware platform being used.
- the programming environment being used.

How Measurements are Calculated

Figure 0-8 details how measurements are calculated. It shows the order in which the various power meter functions are implemented in the measurement calculation.

Figure 0-8: How Measurements are Calculated

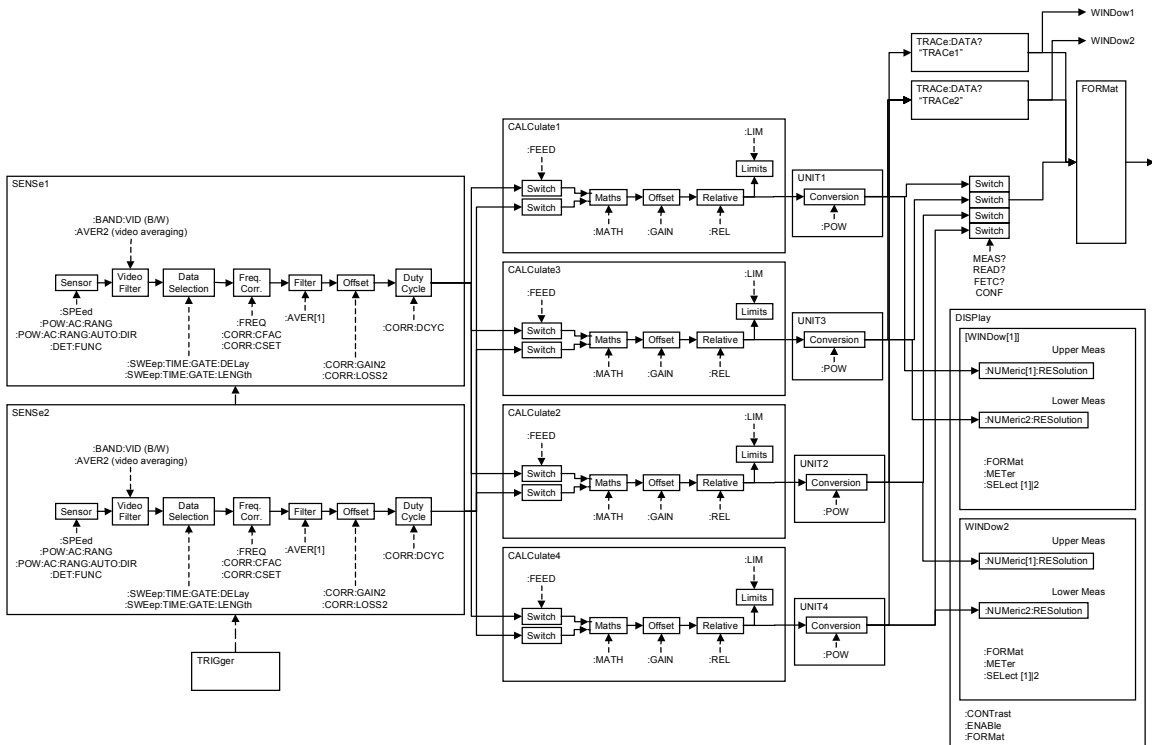

The MEASure commands in this figure can be replaced with the FETCh ? and READ? commands.

Note

All references to channel B in the above diagram refer to the E4417A only. MEAS [1 | 2] : POW : AC ? and MEAS [1 | 2] : POW : AC : REL ? are the only commands that apply to the E4416A.

Status Reporting

Status reporting is used to monitor the power meter to determine when events have occurred. Status reporting is accomplished by configuring and reading status registers.

The power meter has the following main registers:

- Status Register
- Standard Event Register
- Operation Status Register
- Questionable Status Register
- Device Status Register

A number of other registers exist “behind” these and are described later in this chapter.

Status and Standard Event registers are read using the IEEE-488.2 common commands.

Operation and Questionable Status registers are read using the SCPI *STATus* command subsystem.

The General Status Register Model

The generalized status register model shown in Figure 0-9 is the building block of the SCPI status system. This model consists of a condition register, a transition filter, an event register and an enable register. A set of these registers is called a status group.

Figure 0-9: Generalized Status Register Model

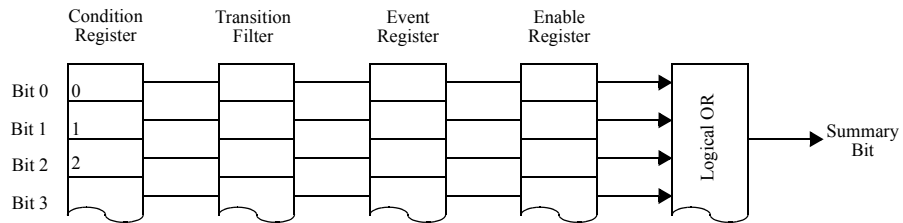

When a status group is implemented in an instrument, it always contains all of the component registers. However, there is not always a corresponding command to read or write to every register.

Condition Register

The condition register continuously monitors the hardware and firmware status of the power meter. There is no latching or buffering for this register, it is updated in real time. Condition registers are read-only.

Transition Filter

The transition filter specifies which types of bit state changes in the condition registers will set corresponding bits in the event register. Transition filter bits may be set for positive transitions (PTR), negative transitions (NTR), or both. Transition filters are read-write. They are unaffected by *CLS or queries. After STATus:PRESet the NTR register is set to 0 and all bits of the PTR are set to 1.

Event Register

The event register latches transition events from the condition register as specified by the transition filter. Bits in the event register are latched and once set they remain set until cleared by a query or a *CLS. Once set, an event bit is no longer affected by condition changes. It remains set until the event register is cleared; either when you read the register or when you send the *CLS (clear status) command. Event registers are read-only.

Enable Register

The enable register specifies the bits in the event register that can generate a summary bit. The instrument logically ANDs corresponding bits in the event and enable registers and ORs all the resulting bits to obtain a summary bit. Enable registers are read-write. Querying an enable register does not affect it.

An Example Sequence

Figure 0-10 illustrates the response of a single bit position in a typical status group for various settings. The changing state of the condition in question is shown at the bottom of the figure. A small binary table shows the state of the chosen bit in each status register at the selected times T1 to T5.

Figure 0-10: Typical Status Register Bit Changes

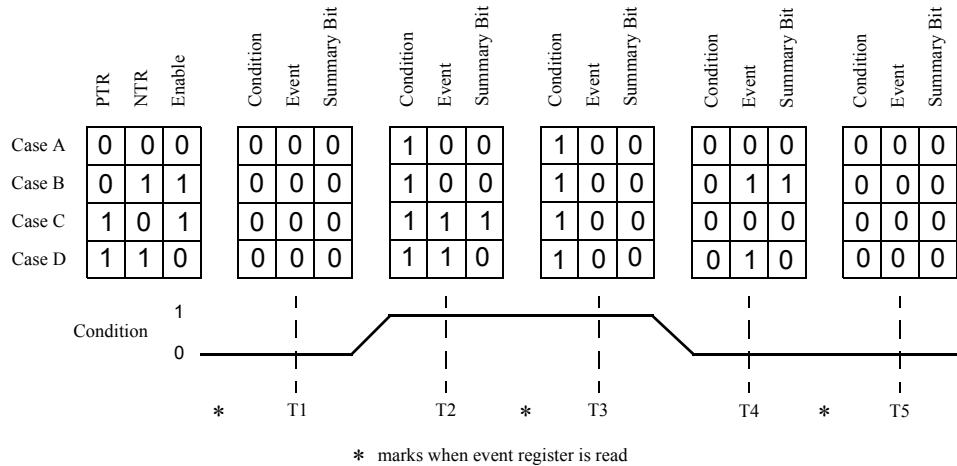

How to Use Registers

There are two methods you can use to access the information in status groups:

- the polling method, or
- the service request (SRQ) method.

Use the polling method when:

- your language/development environment does not support SRQ interrupts.
- you want to write a simple, single purpose program and do not want to add the complexity of setting an SRQ handler.

Use the SRQ method when you:

- need time critical notification of changes.
- are monitoring more than one device which supports SRQ interrupts.
- need to have the controller do something else while it's waiting.
- cannot afford the performance penalty inherent to polling.

The Condition Polling Method

In this polling method, the power meter has a passive role. It only informs the controller that conditions have changed when the controller asks. When you monitor a condition with the polling method, you must:

1. Determine which register contains the bit that monitors the condition.
2. Send the unique GPIB query that reads that register.
3. Examine the bit to see if the condition has changed.

The polling method works well if you do not need to know about the changes the moment they occur. The SRQ method is more effective if you must know immediately when a condition changes. Detecting an immediate change in a condition using the polling method requires your program to continuously read the registers at very short intervals. This is not particularly efficient and there is a possibility that an event may be missed.

The SRQ Method

When a bit of the Status Register is set and has been enabled to assert SRQ (*SRE command), the power meter sets the GPIB SRQ line true. This interrupt can be used to interrupt your program to suspend its current operation and find out what service the power meter requires. Refer to your computer and language manuals for information on how to program the computer to respond to the interrupt.

To allow any of the Status Register bits to set the SRQ line true, you must enable the appropriate bit(s) with the *SRE command. For example, if your application requires an interrupt whenever a message is available in the output queue (Status Register bit 4, decimal weight 16). To enable bit 4 to assert SRQ, use the command *SRE 16

Note

You can determine which bits are enabled in the Status Register using *SRE?. This command returns the decimal weighted sum of all the bits.

Procedure

- Send a bus device clear message.
- Clear the event registers with the *CLS (clear status) command.
- Set the *ESE (standard event register) and *SRE (status byte register) enable masks.
- Enable your bus controller's IEEE-488 SRQ interrupt.

Examples

The following two examples are written in HP BASIC and illustrate possible uses for SRQ. In both cases, it is assumed that the meter has been zeroed and calibrated.

Example 1:

```
10 ! Program to generate an SRQ when a channel A sensor
20 ! connect or disconnect occurs
30 !
40 ASSIGN @Pm TO 713 ! Power meter GPIB address
50 ON ON INTR 7 GOTO Srq_i ! Define service request handler
60 CLEAR @Pm ! Selective device clear
70 OUTPUT @Pm;"*CLS;*RST" ! Clear registers and reset meter
80 !
90 ! Configure the device status register so that a sensor
100 ! connect or disconnect on channel A will cause an SRQ.
110 !
120 OUTPUT @Pm;"STAT:DEV:ENAB 2"
```



```

130 OUTPUT @Pm;"STAT:DEV:NTR 2"
140 OUTPUT @Pm;"STAT:DEV:PTR 2"
150 OUTPUT @Pm;"*SRE 2"
160 !
170 ENABLE INTR 7;2 ! Enable an SRQ to cause an interrupt
180 LOOP ! Idle loop
190 ! Forever
200 END LOOP
210 !
220 ! When a SRQ is detected , the following routine will
    service it.
230 !
240 Srq_i: !
250 St=SPOLL(@Pm) ! Serial Poll (reads status byte)
260 IF BIT(St,1)=1 THEN ! Device status reg bit set ?
270 OUTPUT @Pm;"STAT:DEV:EVENT?" ! Yes , read register
280 ENTER @Pm;Event ! (this also clears it)
290 OUTPUT @Pm;"STAT:DEV:COND?"
300 ENTER @Pm;Cond
310 IF Cond=0 THEN
320 PRINT "Sensor disconnected"
330 ELSE
340 PRINT "Sensor connected"
350 END IF
360 END IF
370 GOTO 170 ! Return to idle loop
380 END

```

Example 2:

```

10 ! Program to generate an SRQ when an over limit
20 ! condition occurs.
30 !
40 ASSIGN @Pm TO 713 ! Power meter GPIB address
50 ON INTR 7 GOTO Srq_i ! Define service request handler
60 CLEAR @Pm ! Selective device clear
70 OUTPUT @Pm;"*CLS" ! Clear registers
80 OUTPUT @Pm;"SYST:PRES" ! Preset meter
90 !
100 ! Set upper limit to 2dBm and configure the operation
    status
110 ! so that an over limit condition will cause an SRQ.
120 !

```

Power Meter Remote Operation Status Reporting

```
130  OUTPUT @Pm;"SENS:LIM:UPP 2DBM"  
140  OUTPUT @Pm;"SENS:LIM:STAT ON"  
150  OUTPUT @Pm;"STAT:OPER:PTR 4096"  
160  OUTPUT @Pm;"STAT:OPER:ENAB 4096"  
170  OUTPUT @Pm;"*SRE 128"  
180  !  
190  ENABLE INTR 7;2  ! Enable an SRQ to cause an interrupt  
200  LOOP              ! Idle loop  
210  ! Forever  
220  END LOOP  
230  !  
240  ! When a SRQ is detected , the following routine will  
      service it.  
250  !  
260  Srq_i:          !  
270  St=SPOLL(@Pm)      ! Serial Poll (reads status byte)  
280  IF BIT(St,7)=1 THEN  ! Operation status bit set?  
290  OUTPUT @Pm;"STAT:OPER?"! Yes , read register  
300  ENTER @Pm;Oper      ! (this also clears it)  
310  OUTPUT @Pm;"STAT:OPER:ULF?"  
320  ENTER @Pm;Ulf  
330  IF Ulf=2 THEN PRINT "Over limit detected"  
340  END IF  
350  GOTO 190           ! Return to idle loop  
360  END
```

Status Registers

The Status System in the power meter is shown in Figure 0-11. The Operation Status and Questionable Status groups are 16 bits wide, while the Status Byte and Standard Event groups are 8 bits wide. In all 16-bit groups, the most significant bit (bit 15) is not used and is always set to 0.

Figure 0-11: Status System

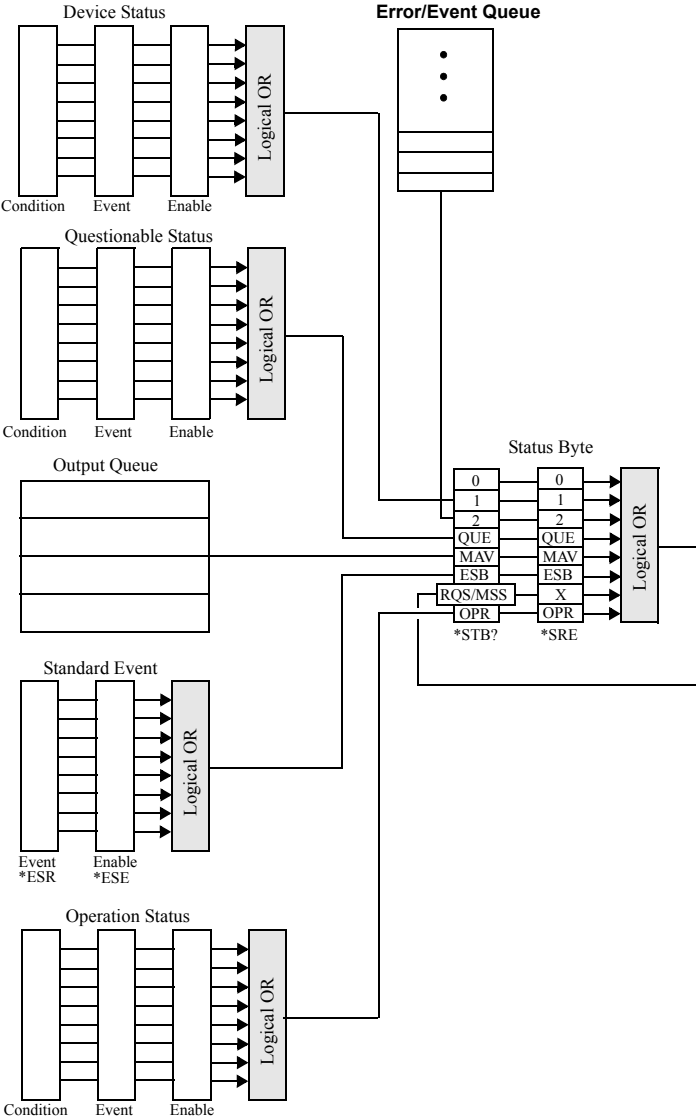

The Status Byte Summary Register

The status byte summary register reports conditions from other status registers. Query data waiting in the power meter's output buffer is immediately reported through the "message available" bit (bit 4). Clearing an event register clears the corresponding bits in the status byte summary register. Reading all messages in the output buffer, including any pending queries, clears the message available bit.

Table 0-3: Bit Definitions - Status Byte Register

Bit Number	Decimal Weight	Definition
0	1	Not Used (Always set to 0)
1	2	Device Status Register summary bit. One or more bits are set in the Device Status Register (bits must be "enabled" in enable register)
2	4	Error/Event Queue
3	8	Questionable Status Register summary bit. One or more bits are set in the Questionable Status Register (bits must be "enabled" in enable register).
4	16	Data Available Data is available in the power meter's output buffer.
5	32	Standard Event One or more bits are set in the Standard Event register (bits must be "enabled" in enable register).
6	64	Request Service The power meter is requesting service (serial poll).
7	128	Operation Status Register summary bit. One or more bits are set in the Operation Status Register (bits must be "enabled" in enable register).

Particular bits in the status byte register are cleared when:

- The standard event, Questionable status, operation status and device status are queried.
- The error/event queue becomes empty.
- The output queue becomes empty.

The status byte enable register (SRE, service request enable) is cleared when you:

- cycle the instrument power.
- execute a *SRE 0 command.

Using *STB? to Read the Status Byte

The *STB? (status byte query) command is similar to a serial poll except it is processed like any other power meter command. The *STB? command returns the same result as an IEEE-488 serial poll except that the request service bit (bit 6) *is not* cleared if a serial poll has occurred. The *STB? command is not handled automatically by the IEEE-488 bus interface hardware and the command will be executed only after previous commands have completed. Using the *STB? command does not clear the status byte summary register.

The Standard Event Register

The standard event register reports the following types of instrument events: power-on detected, command and syntax errors, command execution errors, self-test or calibration errors, query errors, or when an overlapped command completes following a *OPC command. Any or all of these conditions can be reported in the standard event summary bit through the enable register. You must write a decimal value using the *ESE (event status enable) command to set the enable register mask.

Table 0-4: Bit Definitions - Standard Event Register

Bit Number	Decimal Value	Definition
0	1	Operation Complete All overlapped commands following an *OPC command have been completed.
1	2	Not Used. (Always set to 0.)
2	4	Query Error A query error occurred, refer to error numbers 410 to 440 in the <i>User's Guide</i> .
3	8	Device Error A device error occurred, refer to error numbers 310 to 350 in the <i>User's Guide</i> .
4	16	Execution Error An execution error occurred, refer to error numbers 211 to 241 in the <i>User's Guide</i> .
5	32	Command Error A command syntax error occurred, refer to error numbers 101 to 161 in the <i>User's Guide</i> .
6	64	User request.
7	128	Power On Power has been turned off and on since the last time the event register was read or cleared.

The standard event register is cleared when you:

- send a *CLS (clear status) command.
- query the event register using the *ESR? (event status register) command.

The standard event enable register is cleared when you:

- cycle the instrument power.
- execute a *ESE 0 command.

Questionable Status Register

The questionable status register provides information about the quality of the power meter's measurement results. Any or all of these conditions can be reported in the questionable data summary bit through the enable register. You must write a value using the `STATUS:QUESTIONABLE:ENABLE` command to set the enable register mask.

The questionable status model is shown in the pullout at the end of this chapter.

The following bits in these registers are used by the power meter.

Bit Number	Decimal Weight	Definition
0 to 2	-	Not used
3	8	POWER Summary
4 to 7	-	Not used
8	256	CALibration Summary
9	512	Power On Self Test
10 to 14	-	Not Used
15	-	Not used (always 0)

Power Meter Remote Operation
Status Reporting

The condition bits are set and cleared under the following conditions:

Bit Number	Meaning	EVENTs Causing Bit Changes
3	POWer Summary	<p>This is a summary bit for the Questionable POWER Register.</p> <ul style="list-style-type: none"> • SET: <ul style="list-style-type: none"> Error -230, "Data corrupt or stale" Error -231, "Data questionable;Input Overload" Error -231, "Data questionable;Input Overload ChA"¹ Error -231, "Data questionable;Input Overload ChB"¹ Error -231, "Data questionable;PLEASE ZERO" Error -231, "Data questionable;PLEASE ZERO ChA"¹ Error -231, "Data questionable;PLEASE ZERO ChB"¹ Error -231, "Data questionable;Lower window log error"¹ Error -231, "Data questionable;Upper window log error"¹ • CLEARED: When no errors are detected by the power meter during a measurement covering the causes given for it to set.
8	CALibration Summary	<p>This is a summary bit for the Questionable CALibration Register.</p> <ul style="list-style-type: none"> • SET: <ul style="list-style-type: none"> These may be caused by CALibration[1 2]:ZERO:AUTO ONCE or CALibration[1 2]:AUTO ONCE or CALibration[1 2][:ALL] or CALibration[1 2][:ALL]? Error -231, "Data questionable; ZERO ERROR" Error -231, "Data questionable; ZERO ERROR ChA"¹ Error -231, "Data questionable; ZERO ERROR ChB"¹ Error -231, "Data questionable; CAL ERROR" Error -231, "Data questionable; CAL ERROR ChA"¹ Error -231, "Data questionable; CAL ERROR ChB"¹ • CLEARED: When any of the commands listed above succeed and no errors are placed on the error queue.
9	Power On Self Test	<ul style="list-style-type: none"> • SET: This bit is set when the power on self test fails. • CLEARED: When the power on self test passes.

1. E4417A only

Operation Status

The Operation Status group monitors conditions in the power meter's measurement process.

The Operation status model is shown in the pullout at the end of this chapter.

The following bits in these registers are used by the power meter:

Bit Number	Decimal Weight	Definition
0	1	CALibrating Summary
1 - 3	-	Not used
4	16	MEASuring Summary
5	32	Waiting for TRIGger Summary
6 - 9	-	Not used
10	1024	SENSE Summary
11	2048	Lower Limit Fail Summary
12	4096	Upper Limit Fail Summary
13 to 14	-	Not used
15	-	Not used (always 0)

The condition bits are set and cleared under the following conditions:

Bit Number	Meaning	EVENTs Causing Bit Changes
0	CALibrating	<p>This is a summary bit for the Operation CALibrating Register.</p> <ul style="list-style-type: none"> • SET: At beginning of zeroing (CALibration:ZERO:AUTO ONCE) and at the beginning of calibration (CALibration:AUTO ONCE). Also for the compound command/query CALibration[:ALL]?, this bit is set at the beginning of the zero. • CLEARED: At the end of zeroing or calibration.

Power Meter Remote Operation
Status Reporting

Bit Number	Meaning	EVENTs Causing Bit Changes
4	MEASuring	This is a summary bit for the Operation MEASuring Register. <ul style="list-style-type: none"> • SET: When the power meter is taking a measurement. • CLEARED: When the measurement is finished.
5	Waiting for TRIGger	This is a summary bit for the Operation TRIGger Register. <ul style="list-style-type: none"> • SET: When the power meter enters the “wait for trigger” state. • CLEARED: When the power meter enters the “idle” state.
10	SENSE	This is a summary bit for the Operation SENSE Register. <ul style="list-style-type: none"> • SET: When the power meter is reading data from the E-Series power sensor EEPROM. • CLEARED: When the power meter is not reading data from the E-Series power sensor or N8480 Series power sensor EEPROM.
11	Lower Limit Fail	This is a summary bit for the Lower Limit Fail Register. <ul style="list-style-type: none"> • SET: If a measurement is made and either a channel or window lower limit test fails. • CLEARED: If a measurement is made and the lower limit test is not enabled or the test is enabled and passes.
12	Upper Limit Fail	This is a summary bit for the Upper Limit Fail Register. <ul style="list-style-type: none"> • SET: If a measurement is made and either a channel or window upper limit test fails. • CLEARED: If a measurement is made and the upper limit test is not enabled or the test is enabled and passes.

Device Status Register

The device status register set contains bits which give device dependent information.

The following bits in these registers are used by the power meter:

Bit Number	Decimal Weight	Definition
0	-	Not used
1	2	Channel A sensor connected
2	4	Channel B sensor connected ¹
3	8	Channel A sensor error
4	16	Channel B sensor error ¹
5	32	Channel A sensor Front/Rear
6	64	Channel B sensor Front/Rear ¹
14	16384	Front Panel key press

1. E4417A only

Power Meter Remote Operation
Status Reporting

The condition bits are set and cleared under the following conditions:

Bit Number	Meaning	EVENTs Causing Bit Changes
1	Channel A sensor connected	<ul style="list-style-type: none"> • SET: When a power sensor is connected to the Channel A input. • CLEARED: When no power sensor is connected to the Channel A input.
2	Channel B sensor connected	<ul style="list-style-type: none"> • SET: When a power sensor is connected to the Channel B input. • CLEARED: When no power sensor is connected to the Channel B input.
3	Channel A error	<ul style="list-style-type: none"> • SET: If the power sensor EEPROM on Channel A has failed or if there are power sensors connected to both the rear and front panel Channel A connectors. • CLEARED: In every other condition.
4	Channel B error	<ul style="list-style-type: none"> • SET: If the power sensor EEPROM on Channel B has failed or if there are power sensors connected to both the rear and front panel Channel B connectors. • CLEARED: In every other condition.
5	Channel A Front/Rear	<ul style="list-style-type: none"> • SET: If a power sensor is connected to the Channel A rear panel. • CLEARED: If a power sensor is connected to the Channel A front panel.
6	Channel B Front/Rear	<ul style="list-style-type: none"> • SET: If a power sensor is connected to the Channel B rear panel. • CLEARED: If a power sensor is connected to the Channel B front panel.
14	Front Panel Key Press	<p>This is an event, and DOES NOT set the condition register. The bit will be set in the event register which will be cleared when read. Note that the transition registers are of no use for this bit.</p>

Using the Operation Complete Commands

The *OPC? and *OPC commands allow you to maintain synchronization between the computer and the power meter. The *OPC? query command places an ASCII character 1 into the power meter's output queue when all pending power meter commands are complete. If your program reads this response before continuing program execution, you can ensure synchronization between one or more instruments and the computer.

The *OPC command sets bit 0 (Operation Complete) in the Standard Event Status Register when all pending power meter operations are complete. By enabling this bit to be reflected in the Status Register, you can ensure synchronization using the GPIB serial poll.

Procedure

- Send a device clear message to clear the power meter's output buffer.
- Clear the event registers with the *CLS (clear status) command.
- Enable operation complete using the *ESE 1 command (standard event register).
- Send the *OPC? (operation complete query) command and enter the result to assure synchronization.
- Send your programming command string, and place the *OPC (operation complete) command as the last command.
- Use a serial poll to check to see when bit 5 (standard event) is set in the status byte summary register. You could also configure the power meter for an SRQ interrupt by sending *SRE 32 (status byte enable register, bit 5).

Examples

This example program uses the *OPC? command to determine when the power meter has finished calibrating.

```
CAL:AUTO ONCE
*OPC?
MEAS:POW:AC?
```

This example program, in HP Basic, uses the *OPC command and serial poll to determine when the power meter has finished calibrating. The advantage to using this method over the *OPC? command is that the computer can perform other operations while it is waiting for the power meter to finish calibrating.

```
10 ASSIGN @Power TO 713
20 OUTPUT @Power;"*CLS"
30 OUTPUT @Power;"*ESE 1"
40 OUTPUT @Power;"CAL:AUTO ONCE;*OPC"
50 WHILE NOT BIT(S POLL(@Power),5)
60 !(Computer carries out other operations here)
70 END WHILE
80 OUTPUT @Power;"MEAS:POW:AC?"
90 ENTER @Power;Result
100 PRINT Result
110 END
```

Saving and Recalling Power Meter Configurations

To reduce repeated programming, up to ten power meter configurations can be stored in the power meter's non-volatile memory. The error list, GPIB address, programming language, sensor calibration table data, zeroing and calibration information are not stored.

How to Save and Recall a Configuration

Power meter configurations are saved and recalled with the following commands:

```
*SAV <NRf>  
*RCL <NRf>
```

The range of values for <NRf> in the above commands is 1 to 10.

Example Program

```
10 ASSIGN @POWER TO 713  
20 !Configure the power meter  
30 OUTPUT @POWER;"UNIT:POW W"  
40 OUTPUT @POWER;"SENS:CORR:LOSS2 -10"  
50 OUTPUT @POWER;"SENS:CORR:LOSS2:STAT ON"  
60 !Save the configuration  
70 OUTPUT @POWER;"*SAV 5"  
80 PRINT "Configuration Saved"  
90 !Now reset the power meter  
100 OUTPUT @POWER;"*RST"  
110 !Recall the configuration  
120 OUTPUT @POWER;"*RCL 5"  
130 PRINT "Configuration Recalled"  
140 PRINT "Save and Recall complete"  
150 END
```

Using Device Clear to Halt Measurements

Device clear is an IEEE-488 low-level bus message which can be used to halt measurements in progress. Different programming languages and IEEE-488 interface cards provide access to this capability through their own unique commands. The status registers, the error queue, and all configuration states are left unchanged when a device clear message is received. Device clear performs the following actions.

- All measurements in progress are aborted.
- The power meter returns to the trigger “idle state”.
- The power meter’s input and output buffers are cleared.
- The power meter is prepared to accept a new command string.

An Introduction to the SCPI Language

Standard Commands for Programmable Instruments (SCPI) defines how you communicate with an instrument from a bus controller. The SCPI language uses a hierarchical structure similar to the file systems used by many bus controllers. The command tree is organized with root-level commands (also called subsystems) positioned at the top, with multiple levels below each root-level command. You must specify the complete path to execute the individual lower-level commands.

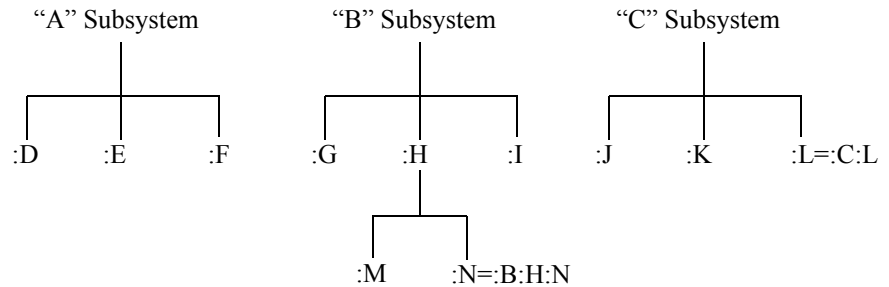

Mnemonic Forms

Each keyword has both a long and a short form. A standard notation is used to differentiate the short form keyword from the long form keyword. The long form of the keyword is shown, with the short form portion shown in uppercase characters, and the rest of the keyword shown in lowercase characters. For example, the short form of TRIGger is TRIG.

Using a Colon (:)

When a colon is the first character of a command keyword, it indicates that the next command mnemonic is a root-level command. When a colon is inserted between two command mnemonics, the colon moves the path down one level in the present path (for the specified root-level command) of the command tree. You *must* separate command mnemonics from each other using a colon. You can omit the leading colon if the command is the first of a new program line.

Using a Semicolon (;)

Use a semicolon to separate two commands within the same command string. The semicolon does not change the present path specified. For example, the following two statements are equivalent. Note that in the first statement the first colon is optional but the third is compulsory.

```
:DISP:FORM DIG; :DISP:RES 2  
:DISP:FORM DIG;RES 2
```

Using a Comma (,)

If a command requires more than one parameter, you must separate adjacent parameters using a comma.

Using Whitespace

You *must* use whitespace characters, [tab], or [space] to separate a parameter from a command keyword. Whitespace characters are generally ignored *only* in parameter lists.

Using “?” Commands

The bus controller may send commands at any time, but a SCPI instrument may only send responses when *specifically* instructed to do so. Only query commands (commands that end with a “?”) will instruct the instrument to send a response message. Queries return either measured values or internal instrument settings.

Note

If you send two query commands without reading the response from the first, then attempt to read the second response, you may receive some data from the first response followed by the complete second response. To avoid this, do not send a query command without reading the response. When you cannot avoid this situation, send a device clear before sending the second query command.

Using “*” Commands

Commands starting with a “*” are called common commands. They are required to perform the identical function for *all* instruments that are compliant with the IEEE-488.2 interface standard. The “*” commands are used to control reset, self-test, and status operations in the power meter.

Syntax Conventions

Throughout this guide, the following conventions are used for SCPI command syntax.

- Square brackets ([]) indicate optional keywords or parameters.
- Braces ({}) enclose one or more parameters that may be included zero or more times.
- Triangle brackets (<>) indicate that you must substitute a value for the enclosed parameter.
- Bars (|) can be read as “or” and are used to separate alternative parameter options.

Syntax Diagram Conventions

- Solid lines represent the recommended path.
- Ovals enclose command mnemonics. The command mnemonic must be entered exactly as shown.
- Dotted lines indicate an optional path for bypassing secondary keywords.
- Arrows and curved intersections indicate command path direction.

SCPI Data Types

The SCPI language defines different data formats for use in program messages and response messages. Instruments are flexible listeners and can accept commands and parameters in various formats. However, SCPI instruments are precise talkers. This means that SCPI instruments *always* respond to a particular query in a predefined, rigid format.

<boolean> Definition

Throughout this chapter <boolean> is used to represent ON | OFF | <NRf>. boolean parameters have a value of 0 or 1 and are unitless. ON corresponds to 1 and OFF corresponds to 0.

On input, an <NRf> is rounded to an integer. A nonzero result is interpreted as 1.

Queries always return a 1 or 0, never ON or OFF.

<character_data> Definition

Throughout this chapter <character_data> is used to represent character data, that is, A - Z, a - z, 0 - 9 and _ (underscore). For example: START and R6_5F. The format is defined as:

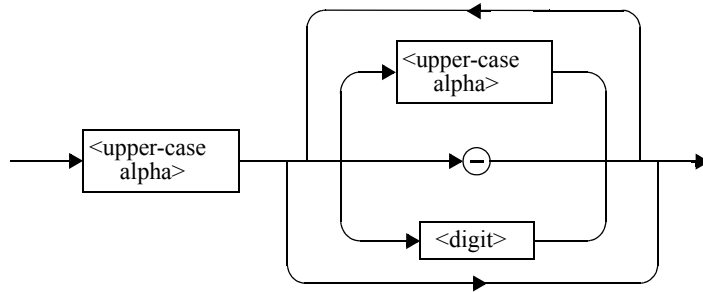

<NAN> Definition

Not a number (NAN) is represented as 9.91 E37. Not a number is defined in IEEE 754.

<non-decimal numeric> Definition

Throughout this chapter <non-decimal numeric> is used to represent numeric information in bases other than ten (that is, hexadecimal, octal and binary). The following syntax diagram shows the standard for these three data structures. For example, #HA2F, #ha4e, #Q62, #q15, #B01011.

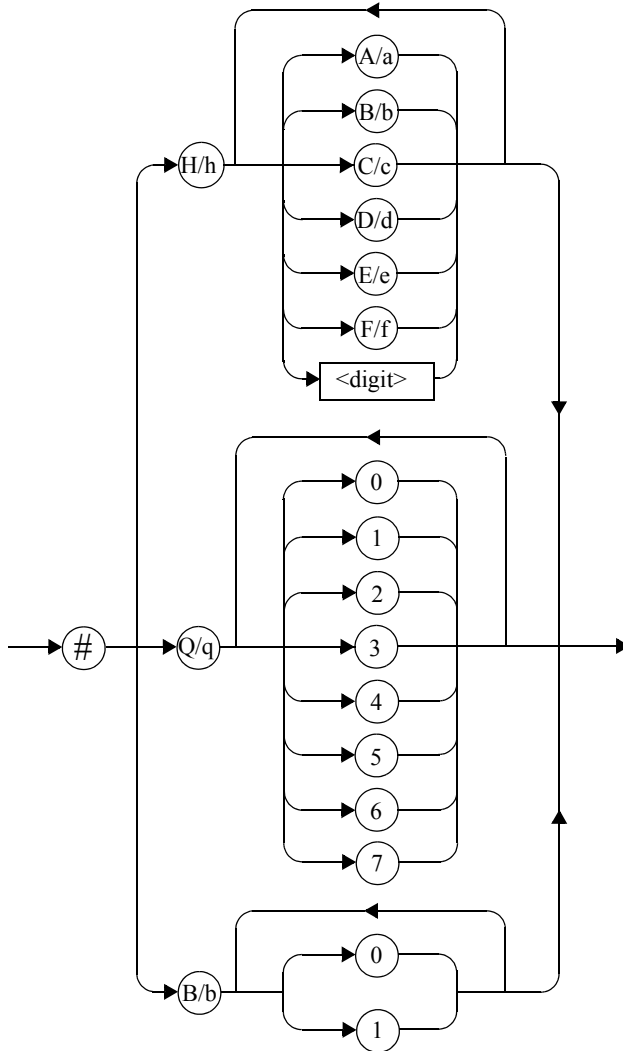

Refer to section 7.7.4.1 of IEEE 488.2 for further details.

<NRf> Definition

Throughout this chapter <NRf> is used to denote a flexible numeric representation. For example: +200; -56; +9.9E36. Refer to section 7.7.2.1 of IEEE 488.2 for further details.

<NR1> Definition

Throughout this chapter <NR1> numeric response data is defined as:

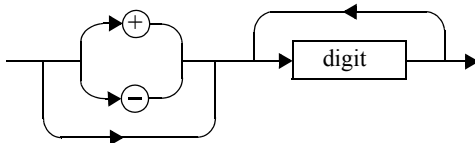

For example:

- 146
- +146
- -12345

Refer to section 8.7.2 of IEEE 488.2 for further details.

<NR2> Definition

Throughout this chapter <NR2> numeric response data is defined as:

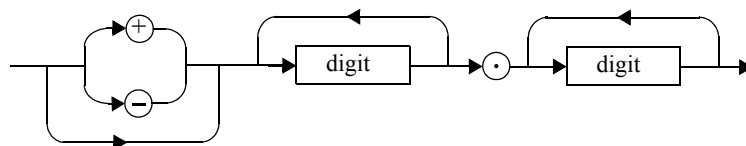

For example:

- 12.3
- +1.2345
- -0.123

Refer to section 8.7.3 of IEEE 488.2 for further details.

<NR3> Definition

Throughout this chapter <NR3> numeric response data is defined as:

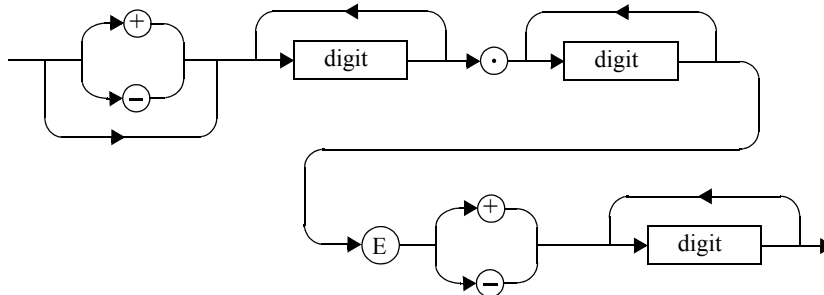

For example:

- 1.23E+6
- 123.4E-54
- -1234.567E+90.

Refer to section 8.7.4 of IEEE 488.2 for further details.

<numeric_value> Definition

Throughout this chapter the decimal numeric element is abbreviated to <numeric_value>. For example, <NRf>, MINimum, MAXimum, DEFault or Not A Number (NaN).

<string> Definition

Throughout this chapter <string> is used to represent 7-bit ASCII characters.

The format is defined as:

Program Data

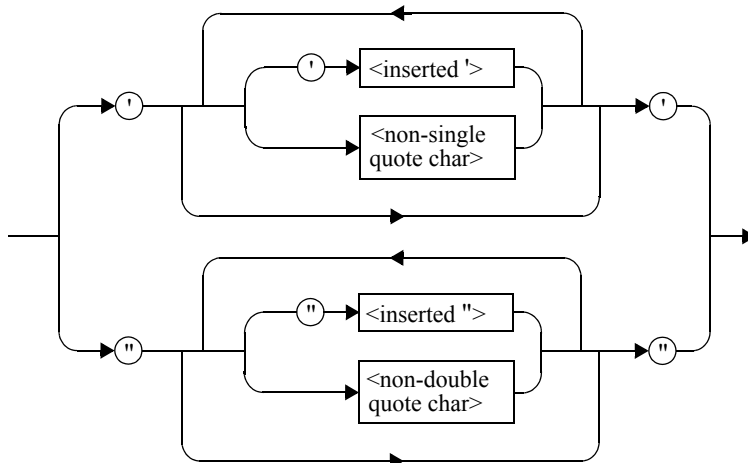

Response Data

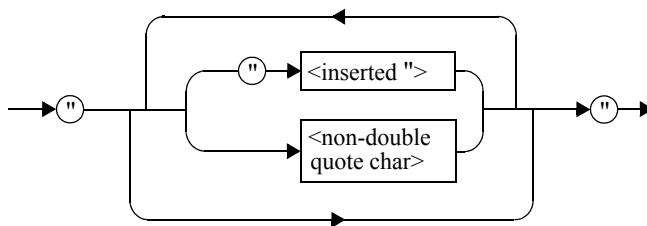

Input Message Terminators

Program messages sent to a SCPI instrument *must* terminate with a <newline> character. The IEEE.488 EOI (end or identify) signal is interpreted as a <newline> character and may also be used to terminate a message in place of the <newline> character. A <carriage return> followed by a <newline> is also accepted. Many programming languages allow you to specify a message terminator character or EOI state to be automatically sent with each bus transaction. Message termination *always* sets the current path back to the root-level.

Summary Of Commands

Note

This Guide details the commands available for both the E4416A and the E4417A power meters. As the E4416A is a single channel power meter only channel A can be selected. Where instances of channel selection are detailed in this chapter they are only relevant for the E4417A.

This section summarizes the SCPI (Standard Commands for Programmable Instruments) commands available to program the power meter. All the commands listed also have queries unless otherwise stated in the “Notes” column. Refer to later chapters for more details on each command.

In different subsystems the numeric suffix of program mnemonics can represent either a channel selection or a window selection. Refer to the appropriate command description to verify the meaning of the numeric suffix.

With commands that require you to specify a channel, Channel A is represented by a 1 and Channel B by a 2. If you omit the channel number, Channel A is assumed.

With commands that require you to specify a window, the upper window is represented by a 1 and the lower window by a 2. If you omit the window number, the upper window is assumed.

MEASurement Commands

Keyword	Parameter Form	Notes
CONFigure[1] 2 3 4		[query only]
CONFigure[1] 2 3 4 [:SCALar]		
[:POWer:AC]	<expected_value> [,<resolution>[,<source list>]]	[no query]
:RELative	<expected_value> [,<resolution>[,<source list>]]	[no query] [non-SCPI]
:DIFFerence	<expected_value> [,<resolution>[,<source list>]]	[no query] [non-SCPI]
:RELative	<expected_value> [,<resolution>[,<source list>]]	[no query] [non-SCPI]
:RATio	<expected_value> [,<resolution>[,<source list>]]	[no query]
:RELative	<expected_value> [,<resolution>[,<source list>]]	[no query] [non-SCPI]
FETCh[1] 2 3 4		
[:SCALar]		
[:POWer:AC]?	<expected_value> [,<resolution>[,<source list>]]	[query only]
:RELative?	<expected_value> [,<resolution>[,<source list>]]	[query only] [non-SCPI]
:DIFFerence?	<expected_value> [,<resolution>[,<source list>]]	[query only] [non-SCPI]
:RELative?	<expected_value> [,<resolution>[,<source list>]]	[query only] [non-SCPI]
:RATio?	<expected_value> [,<resolution>[,<source list>]]	[query only]
:RELative?	<expected_value> [,<resolution>[,<source list>]]	[query only] [non-SCPI]
READ[1] 2 3 4		
[:SCALar]		
[:POWer:AC]?	<expected_value> [,<resolution>[,<source list>]]	[query only]
:RELative?	<expected_value> [,<resolution>[,<source list>]]	[query only] [non-SCPI]
:DIFFerence?	<expected_value> [,<resolution>[,<source list>]]	[query only] [non-SCPI]
:RELative?	<expected_value> [,<resolution>[,<source list>]]	[query only] [non-SCPI]
:RATio?	<expected_value> [,<resolution>[,<source list>]]	[query only]
:RELative?	<expected_value> [,<resolution>[,<source list>]]	[query only] [non-SCPI]

Power Meter Remote Operation Summary Of Commands

Keyword	Parameter Form	Notes
MEASure[1] 2 3 4 [:SCALar]		
[:POWER:AC]?	[<expected_value> [,<resolution>[,<source list>]]]	[query only]
:RELative?	[<expected_value> [,<resolution>[,<source list>]]]	[query only]
:DIFFeRence?	[<expected_value> [,<resolution>[,<source list>]]]	[query only]
:RELative?	[<expected_value> [,<resolution>[,<source list>]]]	[non-SCPI] [query only]
:RATio?	[<expected_value> [,<resolution>[,<source list>]]]	[query only]
:RELative?	[<expected_value> [,<resolution>[,<source list>]]]	[query only] [non-SCPI]

CALCulate Subsystem

Keyword	Parameter Form	Notes
CALCulate[1] 2 3 4		
:FEED[1] 2	<data_handle>	
:GAIN		
[:MAGNitude]	<numeric_value>	
:STATe	<boolean>	
:LIMit		
:CLEAr		
:AUTO	<boolean>	
[:IMMEDIATE]		
:FAIL?		[query only]
:FCOunt?		[query only]
:LOWer		
[:DATA]	<numeric_value>	
:STATe	<boolean>	
:UPPer		
[:DATA]	<numeric_value>	
:MATH		
[:EXPRession]	<string>	
:CATalog?		[query only]
:PHOLd		
:CLEAR		
:RELative		[no query]
[:MAGNitude]		
:AUTO	<boolean>	
:STATe	<boolean>	

CALibration Subsystem

Keyword	Parameter Form	Notes
CALibration[1] 2 [:ALL] [:ALL]?		[event; no query] [event; query]
:AUTO	<boolean> ONCE	
:ECONtrol :STATe	<boolean>	
:RCALibration	<boolean>	
:RCFactor	<numeric_value>	[non-SCPI]
:ZERO :AUTO	<boolean> ONCE	
:NORMal :AUTO	<boolean> ONCE	

DISPlay Subsystem

Keyword	Parameter Form	Notes
DISPlay :CONTRast :ENABLe :SCReen :FORMat	<numeric_value> <boolean> <character_data>	
[:WINDow[1] 2] :ANALog :LOWer :UPPer	<numeric_value> <numeric_value>	
:FORMat :METer :LOWer :UPPer	<character_data> <numeric_value> <numeric_value>	[non-SCPI] [non-SCPI] [non-SCPI]
[:NUMeric[1] 2] :RESolution	<numeric_value>	
:SELect[1] 2 [:STATe]	<boolean>	
:TRACe :FEED :LOWer :UPPer	<character_data> <numeric_value> <numeric_value>	

FORMat Subsystem

Keyword	Parameter Form	Notes
FORMat [:READings]		

Power Meter Remote Operation
Summary Of Commands

Keyword	Parameter Form	Notes
:BORDer [:DATA]	<character_data> <character_data>	

MEMory Subsystem

Keyword	Parameter Form	Notes
MEMory		
:CATalog		
[:ALL]?		[query only]
:STATe?		[query only]
:TABLE?		[query only]
:CLEar		
[:NAME]	<character_data>	[no query], [non-SCPI]
:TABLE		[no query]
:FREE		
[:ALL]?		[query only]
:STATe?		[query only]
:TABLE?		[query only]
:NSTates?		[query only]
:STATe		
:CATalog?		[query only]
:DEFine	<character_data> [, <numeric_value>]	[non-SCPI]
:TABLE		
:FREQuency	<numeric_value> [, <numeric_value>]	
:POINTs?		[query only]
:GAIN		
[:MAGNitude]	<numeric_value> [, <numeric_value>]	[non-SCPI]
:POINTs?		[query only], [non-SCPI]
:MOVE	<character_data>, <character_data>	[no query], [non-SCPI]
:SElect	<character_data>	[no query], [non-SCPI]

OUTPut Subsystem

Keyword	Parameter Form	Notes
OUTPut		
:RECOOrder [1] 2		
:FEED	<data_handle>	
:LIMit		
:LOWer	<numeric_value>	
:UPPer	<numeric_value>	
:STATe	<boolean>	
:ROSCillator		
[:STATe]	<boolean>	
:TRIGger		
[:STATe]	<boolean>	
:TTL [1] 2		

Power Meter Remote Operation
Summary Of Commands

Keyword	Parameter Form	Notes
:ACTive	HIGH LOW	
:FEED	<string>	
:STATe	<boolean>	

[SENSe] Subsystem

Keyword	Parameter Form	Notes
[SENSe[1]] SENSe2		
:AVERage		
:COUNT	<numeric_value>	
:AUTO	<boolean>	
:SDETECT	<boolean>	[non-SCPI]
[:STATe]	<boolean>	
AVERage2		
:COUNT	<numeric_value>	
[:STATe]	<boolean>	
:BANDwidth BWIDth		
:VIDeo	<character_data>	
:CORRection		
:CFACTOR GAIN[1]		[non-SCPI]
[:INPut]		
[:MAGNitude]	<numeric_value>	
:CSET[1] CSET2		
[:SElect]	<string>	
:STATe	<boolean>	
:DCYCLe GAIN3		[non-SCPI]
[:INPut]		
[:MAGNitude]	<numeric_value>	
:STATe	<boolean>	
:FDOFFset GAIN4		
[:INPut]		
[:MAGNitude]?		[query only]
:GAIN2		
:STATe	<boolean>	
[:INPut]		
[:MAGNitude]	<numeric_value>	
:DETECTOR		
:FUNCTION	<character_data>	
:FREQuency		
[:CW] :FIXed	<numeric_value>	
:MRATE	<character_data>	
:POWer		
:AC		
:RANGE	<numeric_value>	[non-SCPI]
:AUTO	<boolean>	
:SPeEd	<numeric_value>	[non-SCPI]
:SWEEp[1] 2 3 4		
:OFFSet		
:TIME	<numeric_value>	
:TIME	<numeric_value>	
:TRACe		
:LIMit		
:LOWer	<numeric_value>	
:UPPer	<numeric_value>	
:OFFSet		

Power Meter Remote Operation
Summary Of Commands

Keyword	Parameter Form	Notes
:TIME	<numeric_value>	
:TIME	<numeric_value>	
:UNIT	<character_data>	
:V2P	ATYPe DTYPe	[non-SCPI]

STATus Subsystem

As the status reporting commands are orthogonal, the same commands apply to all the registers. The registers are:

```

STATus:DEVIce
STATus:OPERation
STATus:OPERation:CALibrating[:SUMMary]
STATus:OPERation:LLFail[:SUMMary]
STATus:OPERation:MEAsuring[:SUMMary]
STATus:OPERation:SENSe[:SUMMary]
STATus:OPERation:TRIGger[:SUMMary]
STATus:OPERation:ULFail[:SUMMary]
STATus:QUESTionable
STATus:QUESTionable:CALibration[:SUMMary]
STATus:QUESTionable:POWer[:SUMMary]

```

The following five commands operate on each of these registers. However, to avoid duplication they are only listed once.

Keyword	Parameter Form	Notes
:CONDition?		[query only]
:ENABle	<NRf> <non-decimal numeric>	
[:EVENT?]		[query only]
:NTRansition	<NRf> <non-decimal numeric>	
:PTRansition	<NRf> <non-decimal numeric>	

SYSTEM Subsystem

Keyword	Parameter Form	Notes
SYSTEM		
:COMMunicate		
:GPIB		
[:SELF]		
:ADDRESS	<numeric_value>	
:SERial		
:CONTRol		
:DTR	<boolean>	
:RTS	<boolean>	
[:RECeive]		
:BAUD	<numeric_value>	
:BITs	<numeric_value>	
:PACE	XON NONE	
:PARity		
[:TYPE]	EVEN ODD ZERO ONE NONE	
:SBITs	<numeric_value>	
:TRANsmit		
:AUTO?		[query only]
:BAUD	<numeric_value>	
:BITs	<numeric_value>	
:ECHO	<boolean>	
:PACE	XON NONE	
:PARity		
[:TYPE]	EVEN ODD ZERO ONE NONE	
:SBITs	<numeric_value>	
:HELP		
:HEADers?		[query only]
:LoCAL		
:PRESet		[event; no query]
:REMote		
:RINTerface	GPIB RS232 RS422	
:RWLock		
:VERSion?		[query only]

TRACe Subsystem

Keyword	Parameter Form	Notes
TRACe[1] 2		
[:DATA] ?	<character_data>	[query only]
:STATe	<boolean>	
:UNIT	<character_data>	

TRIGger Subsystem

Keyword	Parameter Form	Notes
ABORT [1] 2		[no query] [non-SCPI]
INITiate [1] 2 :CONTinuous [:IMMEDIATE]	<boolean>	[no query]
INITiate :CONTinuous :ALL :SEquence [1] 2 [:IMMEDIATE] :ALL :SEquence [1] 2	<boolean> <boolean>	[no query] [no query]
TRIGger [1] 2 :DELay :AUTO [:IMMEDIATE] :SOURce	<boolean> BUS EXTERNAL HOLD IMMEDIATE INTERNAL [1] 2]	[no query]
TRIGger [:SEquence] :DELay :HOLDoff :HYSTERESIS :LEVel :AUTO :SLOPe [:SEquence [1] 2] :COUNT :DELay :AUTO :IMMEDIATE :SOURce	<numeric_value> <numeric_value> <numeric_value> <numeric_value> <boolean> <character_data> <numeric_value> <boolean>	[no query]

UNIT Subsystem

Keyword	Parameter Form	Notes
UNIT [1] 2 3 4 :POWER :RATIO	<amplitude unit> <ratio_unit>	[non-SCPI]

SERvice Subsystem

Keyword	Parameter Form	Notes
SERvice		
:BIST		
:CALibrator	<boolean>	
:FPATH[1] 2		
:MEASure?		[query only]
:REFerence	<numeric_value>	[no query]
:STATe	<boolean>	[no query]
:TBASe		
:STATe	<boolean>	
:TRIG		
:LEVel		
:STATe?		[query only]
:TEST?		[query only]
:OPTion	<character_data>	
:SENSor[1] 2		
:CALFactor	<cal_factor_data>	
:CDATe?		[query only]
:CORRections		
:STATe	<boolean>	
:CPLace?		[query only]
:FREQuency		
:MAXimum?		[query only]
:MINimum?		[query only]
:PCALfactor	<cal_factor_data>	
:POWer		
:AVERage		
:MAXimum?		[query only]
:PEAK		
:MAXimum?		[query only]
:USABle		
:MAXimum?		[query only]
:MINimum?		[query only]
:RADC?		[query only]
:SNUMber?		[query only]
:TNUMber?		[query only]
:TYPE?		[query only]
:SNUMber	<character_data>	
:VERSIon		
:PROcessor	<character_data>	
:SYSTem	<character_data>	

SCPI Compliance Information

The power meter complies with the rules and regulations of the present version of SCPI (Standard Commands for Programmable Instruments). You can determine the SCPI version with which the power meter's is in compliance by sending the `SYSTEM:VERSION?` command from the remote interface.

The following commands are device-specific to the HP EPM-441A/442A. They are not included in the 1996.0 version of the SCPI standard. However, these commands are designed with the SCPI format in mind and they follow all of the syntax rules of the standard.

```
CALibration[1|2]:ECONtrol:STATe
CALibration[1|2]:RCALibration
CALibration[1|2]:RCFactor
DISPlay[:WINDow[1|2]]:FORMat
DISPlay[:WINDow[1|2]]:METer:LOWer
DISPlay[:WINDow[1|2]]:METer:UPPer
DISPlay[:WINDow[1|2]]:RESolution
DISPlay[:WINDow[1|2]]:SELEct
MEMory:CLEar[:NAME]
MEMory:TABLE:SELEct
MEMory:STATE:DEFine
MEMory:TABLE:GAIN[:MAGNitude]
MEMory:TABLE:GAIN:POINTs?
MEMory:TABLE:MOVE
OUTPut:TTL[1|2]:ACTive
OUTPut:TTL[1|2]:FEED
OUTPut:TTL[1|2]:STATe
[SENSe[1]]|SENSe2:AVERage:SDETect
[SENSe[1]]|SENSe2:CORRection:CFACTOR
[SENSe[1]]|SENSe2:CORRection:DCYCLE
[SENSe[1]]|SENSe2:CORRection:FDOFFset
[SENSe[1]]|SENSe2:SPEed
[SENSe[1]]|SENSe2:POWER:AC:RANGe
SERvice:SENSor[1|2]:CDATE?
SERvice:SENSor[1|2]:CPLace?
SERvice:SENSor[1|2]:SNUMber?
SERvice:SENSor[1|2]:TYPE?
SYSTEM:LOCal
SYSTEM:REMote
SYSTEM:RINTerface
SYSTEM:RWLock
```

Power Meter Remote Operation
SCPI Compliance Information

TRANsmit:ECHO
UNIT[1|2]:POWer:RATio

2

———— Measurement Commands

Measurement Commands

Measurement commands are high level commands used to acquire data. They enable you to trade interchangeability against fine control of the measurement process.

Measurement Command	Description
MEASure?	Provides the simplest way to program a power meter for measurements. MEASure? is a compound command which is equivalent to an ABORT followed by a CONFigure and a READ?. It does not enable much flexibility or control over measurement settings.
CONFigure	Used to change the power meter's configuration values. CONFigure must then be followed by another command which takes the measurement—for example, a READ? followed by a FETCh?.
READ?	Takes a measurement using parameters previously set up using either CONFigure or lower level commands. READ? is equivalent to an ABORT followed by an INITiate ¹ (which performs the data acquisition) and a FETCh?
FETCh?	Retrieves measurements taken by INITiate ¹ .

1. INITiate is described in chapter 13, Trigger Subsystem.

The CONFigure, FETCh?, READ? and MEASure? commands all have a numeric suffix which refers to a specific window/measurement. For example:

- CONFigure1? : Returns the configuration of the upper window/upper measurement.
- CONFigure2? : Returns the configuration of the lower window/upper measurement.
- CONFigure3? : Returns the configuration of the upper window/lower measurement.
- CONFigure4? : Returns the configuration of the lower window/lower measurement.

Non-SCPI Command Extensions

The EPM-P series power meters have several command extensions to the SCPI standard: RELative and DIFFerence.

Optional Parameters

CONFigure, FETCh?, READ? and MEASure? have the following three optional parameters:

- An expected power value.
- A resolution.
- A source list.

Expected Power Value

An `<expected_value>` parameter is only required if you are using an E-Series power sensor or N8480 Series power sensor (excluding Option CFT). It has no effect for 8480 Series power sensors and N8480 Series power sensors with Option CFT. The value entered determines which of the power sensor's two ranges is used for the measurement. If the current setting of the power sensor's range is no longer valid for the new measurement, specifying the expected power value decreases the time taken to obtain a result.

Resolution

The `<resolution>` parameter sets the resolution of the specified window. This parameter does not affect the resolution of the GP-IB data but it does affect the auto averaging setting. Where a channel is set up in both the upper and lower window and the `<resolution>` parameter settings for these windows are different, the highest resolution setting is taken to calculate the averaging. If you are making a ratio or difference measurement the `<resolution>` parameters are applied to both channels.

Source List

The `<source list>` parameter is used to define:

- What channel the measurement will be made on, for a dual channel measurement.
- Whether the calculation is channel A-B or B-A, for a dual channel measurement.
- Whether the calculation is A/B or B/A, for a ratio measurement.

Entering a `<source list>` is only required if you are using an E4417A. As the E4416A has a single channel only, the source list can only be channel A.

The following commands are described in this chapter:

Keyword	Parameter Form	Notes	Page
CONFigure[1] 2 3 4		[query only]	page 2-6
CONFigure[1] 2 3 4 [:SCALar]			
[:POWER:AC]	[<expected_value> [,<resolution>[,<source list>]]]	[no query]	page 2-9
:RELative	[<expected_value> [,<resolution>[,<source list>]]]	[no query] [non-SCPI]	page 2-11
:DIFFerence	[<expected_value> [,<resolution>[,<source list>]]]	[no query] [non-SCPI]	page 2-13
:RELative	[<expected_value> [,<resolution>[,<source list>]]]	[no query] [non-SCPI]	page 2-15
:RATio	[<expected_value> [,<resolution>[,<source list>]]]	[no query]	page 2-17
:RELative	[<expected_value> [,<resolution>[,<source list>]]]	[no query] [non-SCPI]	page 2-19
FETCh[1] 2 3 4			
[:SCALar]			
[:POWER:AC]?	[<expected_value> [,<resolution>[,<source list>]]]	[query only]	page 2-22
:RELative?	[<expected_value> [,<resolution>[,<source list>]]]	[query only] [non-SCPI]	page 2-24
:DIFFerence?	[<expected_value> [,<resolution>[,<source list>]]]	[query only] [non-SCPI]	page 2-27
:RELative?	[<expected_value> [,<resolution>[,<source list>]]]	[query only] [non-SCPI]	page 2-29
:RATio?	[<expected_value> [,<resolution>[,<source list>]]]	[query only]	page 2-31
:RELative?	[<expected_value> [,<resolution>[,<source list>]]]	[query only] [non-SCPI]	page 2-33
READ[1] 2 3 4			
[:SCALar]			
[:POWER:AC]?	[<expected_value> [,<resolution>[,<source list>]]]	[query only]	page 2-36
:RELative?	[<expected_value> [,<resolution>[,<source list>]]]	[query only] [non-SCPI]	page 2-38
:DIFFerence?	[<expected_value> [,<resolution>[,<source list>]]]	[query only] [non-SCPI]	page 2-41
:RELative?	[<expected_value> [,<resolution>[,<source list>]]]	[query only] [non-SCPI]	page 2-43
:RATio?	[<expected_value> [,<resolution>[,<source list>]]]	[query only]	page 2-45
:RELative?	[<expected_value> [,<resolution>[,<source list>]]]	[query only] [non-SCPI]	page 2-47

Keyword	Parameter Form	Notes	Page
MEASure[1] 2 3 4 [:SCALar]			
[:POWER:AC]?	[<expected_value> [,<resolution>[,<source list>]]]	[query only]	page 2-50
:RELative?	[<expected_value> [,<resolution>[,<source list>]]]	[query only] [non-SCPI]	page 2-52
:DIFFerence?	[<expected_value> [,<resolution>[,<source list>]]]	[query only] [non-SCPI]	page 2-54
:RELative?	[<expected_value> [,<resolution>[,<source list>]]]	[query only] [non-SCPI]	page 2-56
:RATio?	[<expected_value> [,<resolution>[,<source list>]]]	[query only]	page 2-58
:RELative?	[<expected_value> [,<resolution>[,<source list>]]]	[query only] [non-SCPI]	page 2-60

CONFigure[1]|2|3|4?

This query returns the present configuration of the specified window/measurement.

Syntax

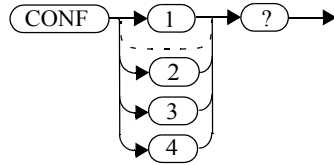

The string returned depends on the setting of the **CALCulate:MATH** and **CALCulate:RELative:STATe** commands.

The configuration is returned as a quoted string in the following format:

"<function> <expected_value>, <resolution>, <source list>"

CALCulate:MATH	CALCulate:RELative:STATe	Function	<source list>
(SENSe1)	OFF	:POW:AC	(@1)
(SENSe2) ¹	OFF	:POW:AC	(@2)
(SENSe1)	ON	:POW:AC:REL	(@1)
(SENSe2) ¹	ON	:POW:AC:REL	(@2)
(SENSe1 - SENSe2) ¹	OFF	:POW:AC:DIFF	(@1),(@2)
(SENSe2 - SENSe1) ¹	OFF	:POW:AC:DIFF	(@2),(@1)
(SENSe1 - SENSe2) ¹	ON	:POW:AC:DIFF:REL	(@1),(@2)
(SENSe2 - SENSe1) ¹	ON	:POW:AC:DIFF:REL	(@2),(@1)
(SENSe1 - SENSe1)	OFF	:POW:AC:DIFF	(@1),(@1)
(SENSe2 - SENSe2) ¹	OFF	:POW:AC:DIFF	(@2),(@2)
(SENSe1 - SENSe1)	ON	POW:AC:DIFF:REL	(@1),(@1)
(SENSe2 - SENSe2) ¹	ON	:POW:AC:DIFF:REL	(@2),(@2)
(SENSe1 / SENSe2) ¹	OFF	:POW:AC:RAT	(@1),(@2)
(SENSe2 / SENSe1) ¹	OFF	:POW:AC:RAT	(@2),(@1)
(SENSe1 / SENSe2) ¹	ON	:POW:AC:RAT:REL	(@1),(@2)
(SENSe2 / SENSe1) ¹	ON	:POW:AC:RAT:REL	(@2),(@1)
(SENSe1/SENSe1)	OFF	POW:AC:RAT	(@1),(@1)

CALCulate:MATH	CALCulate:RELative:STATE	Function	<source list>
(SENSe2/SENSe2) ¹	OFF	POW:AC:RAT	(@2),(@2)
(SENSe1/SENSe1)	ON	POW:AC:RAT:REL	(@1),(@1)
(SENSe2/SENSe2) ¹	ON	POW:AC:RAT:REL	(@2),(@2)

1. E4417A only.

<expected_value> returns the expected value sent by the last CONFigure command or +20 dBm by default. Note that when the display is showing dual windows this value is meaningless.

The <resolution> returned is the same as the value returned by DISPLAY:WINDOW:RESolution?. The format of the return is <NR1> in the range 1 through 4.

Example

CONF2?

This command queries the current configuration of the lower window/upper measurement.

Reset Condition

On reset:

- The command function is set to :POW:AC.
- The expected power level is set to +20 dBm.
- The resolution is set to 3.
- The source list on the E4416A is set to channel A on both windows and their measurements.
- The source list on the E4417A is set to channel A for the upper measurement on both windows and channel B for the lower measurement on both windows.

CONFigure[1|2|3|4] Commands

The CONFigure commands are used on the specified window/measurement to set:

- The expected power level being measured.
- The resolution of the window/measurement.
- The channel(s) on which the measurement is to be made.

The CONFigure commands do not make the power measurement after setting the configuration. Use READ?, or alternatively use INITiate followed by a FETCh? to make the measurement.

The CONFigure command also applies the following defaults to the channel(s) which are in the specified window (the channel(s) in the window are specified in the <source list> parameter):

Default Settings	Description
INITiate:CONTinuous OFF	Sets the power meter to make one trigger cycle when INITiate is sent.
TRIGger:SOURce IMMEDIATE	When TRIG:SOUR is set to BUS or HOLD, sets the power meter to make the measurement immediately a trigger is received.
TRIGger:DELay:AUTO ON	Enables automatic delay before making the measurement.
SENSE:AVERAge:COUNT:AUTO ON	Enables automatic filter length selection.
SENSE:AVERAge:STATe ON	Enables averaging.

CONFigure[1|2|3|4[:SCALar][:POWer:AC] [<expected_value>[,<resolution>[,<source list>]]]

CONFigure[1|2|3|4[:SCALar][:POWer:AC] [<expected_value>[,<resolution>[,<source list>]]]

This command is used on the specified window/measurement to set:

- The expected power level of the measurement.
- The resolution of the window/measurement.
- The channel on which the measurement will be made.

Syntax

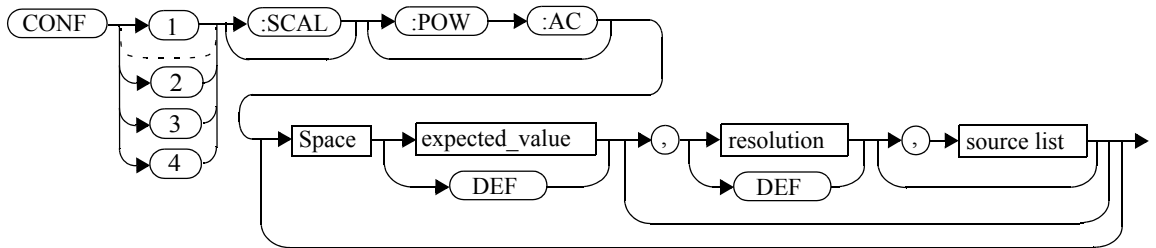

Parameters

Refer to “Optional Parameters”, on page 2-3 for additional details on the parameters in this command.

Item	Description/Default	Range of Values
expected_value	A numeric value for the expected power level. The units of measurement are dBm and W. The default units are defined by UNIT:POWer.	Sensor dependent. DEF ¹
resolution	A numeric value for the resolution. If unspecified the current resolution setting is used.	1 to 4 ² 1.0, 0.1, 0.01, 0.001 DEF ¹
source list	The channel which the command is implemented on. If unspecified the current window setup is used. However, on the E4417A, if the window shows a ratio or difference measurement, the upper window defaults to channel A and the lower window to channel B.	(@1) (@2) ³

1. The mnemonic DEF means DEFault. This is not equivalent to the DEFault parameter used in the command sub-systems. The parameters must be entered in the specified order. If parameters are omitted, they will default from the right. The parameter DEFault is used as a place holder. Specifying DEF leaves the parameter value unchanged.
2. When the measurement result is linear this parameter represents the number of significant digits. When the measurement result is logarithmic 1 to 4 represents a resolution of 1, 0.1, 0.01 and 0.001 respectively.
3. E4417A only.

Example

```
CONF1:POW:AC DEF, 2, (@1)
```

This command configures the upper window/upper measurement to measure the power of channel A, using the current sensor range and a resolution setting of 2.

CONF[1][2|3|4]:**SCAL**[r]:**POW**:**AC**:**REL**ive [<expected_value>[,<resolution>[,<source list>]]

CONF[1][2|3|4]:**SCAL**[r]:**POW**:**AC**:**REL**ive
[<expected_value>[,<resolution>[,<source list>]]]

This command sets the measurement function, range and resolution of the specified window. It sets the measurement function to single channel with relative mode on. The relative value used is that set by the `CALCulate:RELative:MAGNitude:AUTO` command.

Syntax

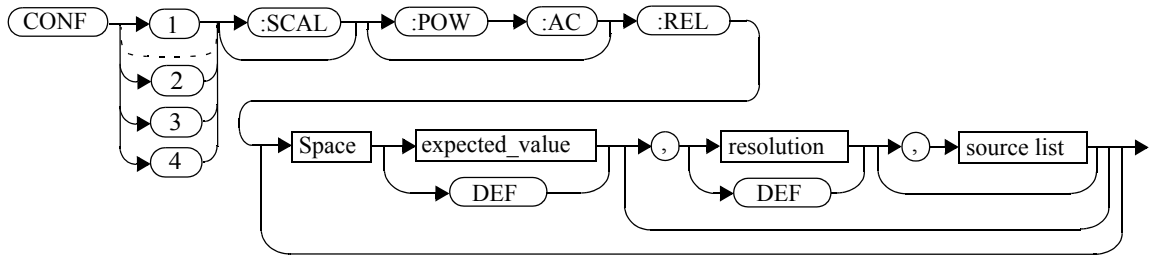

Parameters

Refer to “Optional Parameters”, on page 2-3 for additional details on the parameters in this command.

Item	Description/Default	Range of Values
expected_value (for the expected power level)	A numeric value for the expected power level. The units of measurement are dBm and W. The default units are defined by <code>UNIT:POWer</code> .	sensor dependent DEF ¹
resolution	A numeric value for the resolution. If unspecified the current resolution setting is used.	1 to 4 ² 1.0, 0.1, 0.01, 0.001 DEF ¹
source list	The channel which the command is implemented on. If unspecified the current window setup is used. However, on the E4417A, if the window shows a ratio or difference measurement, the upper window defaults to channel A and the lower window to channel B.	(@1) (@2) ³

CONFigure[1][2][3][4][:SCALar][:POWer:AC]:RELative [<expected_value>[,<resolution>[,<source list>]]]

1. The mnemonic DEF means DEFault. This is not equivalent to the DEFault parameter used in the command sub-systems. The parameters must be entered in the specified order. If parameters are omitted, they will default from the right. The parameter DEFault is used as a place holder. Specifying DEF leaves the parameter value unchanged.
2. When the measurement result is linear this parameter represents the number of significant digits. When the measurement result is logarithmic 1 to 4 represents a resolution of 1, 0.1, 0.01 and 0.001 respectively.
3. E4417A only.

Example

```
CONF2:REL -50DBM,3,(@1)
```

This command configures the lower window to measure the relative power of channel A, using an expected power level of -50 dBm and a resolution setting of 3.

CONFigure[1]]2|3|4[:SCALar][:POWer:AC]:DIFFerence [<expected_value>[,<resolution>[,<source list>]]]

CONFigure[1]]2|3|4[:SCALar][:POWer:AC]:DIFFerence [<expected_value>[,<resolution>[,<source list>]]]

This command sets the measurement function and resolution of the specified window. It sets the measurement function to difference with relative mode off.

Syntax

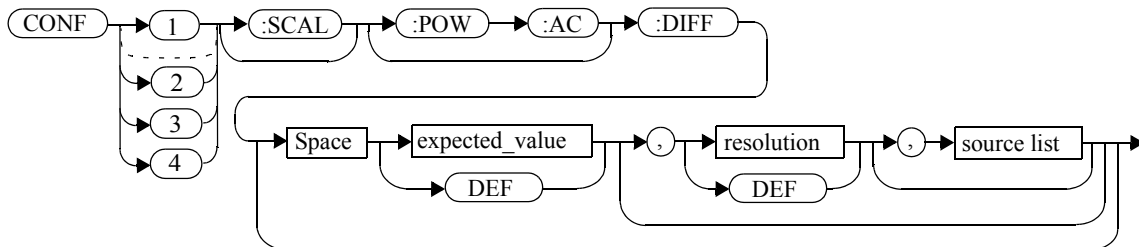

Parameters

Refer to “Optional Parameters”, on page 2-3 for additional details on the parameters in this command.

Item	Description/Default	Range of Values
expected_value (for the expected power level)	The power meter ignores the numeric value entered in this parameter. Any value entered is treated like DEF.	sensor dependent DEF ¹
resolution	A numeric value for the resolution. If unspecified the current resolution setting is used.	1 to 4 ² 1.0, 0.1, 0.01, 0.001 DEF ¹
source list	This channel list specifies between which channels the difference is calculated. If unspecified and the current window setup is a difference measurement then this difference setup is used, otherwise it defaults to channel A-B (E4417A) or A-A (E4416A).	(@1),(@2) ³ (@2),(@1) ³ (@1),(@1) (@2),(@2) ³

CONFigure[1][2][3][4][:SCALar][:POWer:AC]:DIFFerence [<expected_value>,<resolution>,<source list>]]

1. The mnemonic DEF means DEFault. This is not equivalent to the DEFault parameter used in the command sub-systems. The parameters must be entered in the specified order. If parameters are omitted, they will default from the right. The parameter DEFault is used as a place holder. Specifying DEF leaves the parameter value unchanged.
2. When the measurement result is linear this parameter represents the number of significant digits. When the measurement result is logarithmic 1 to 4 represents a resolution of 1, 0.1, 0.01 and 0.001 respectively.
3. E4417A only.

Example

```
CONF2:DIFF DEF,1,(@2),(@1)
```

This command configures the lower window to make a difference measurement of channel B - channel A, using the current sensor range and a resolution of 1 on both channels.

CONFigure[1]|2|3|4[:SCALar][:POWer:AC]:DIFFerence:RELative
 [<expected_value>[,<resolution>[,<source list>]]]

This command sets the measurement function, range and resolution of the specified window. It sets the measurement function to difference with relative mode on. The relative value used is set by the CALCulate:RELative:MAGNitude:AUTO command.

Syntax

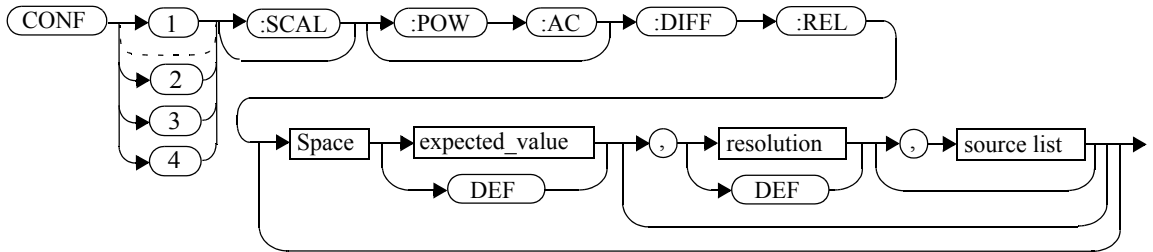

Parameters

Refer to “Optional Parameters”, on page 2-3 for additional details on the parameters in this command.

Item	Description/Default	Range of Values
expected_value (for the expected power level)	The power meter ignores the numeric value entered in this parameter. Any value entered is treated like DEF.	sensor dependent DEF ¹
resolution	A numeric value for the resolution. If unspecified the current resolution setting is used.	1 to 4 ² 1.0, 0.1, 0.01, 0.001 DEF ¹
source list	This channel list specifies the channels used to calculate the difference. If unspecified and the current window setup is a difference measurement then this difference setup is used, otherwise it defaults to channel A-B (E4417A) or A-A (E4416A).	(@1),(@2) ³ (@2),(@1) ³ (@1),(@1) (@2),(@2) ³

Measurement Commands

CONFigure[1]|2|3|4[:SCALar][:POWer:AC]:DIFFerence:RELative
[<expected_value>[,<resolution>[,<source list>]]]

1. The mnemonic DEF means DEFault. This is not equivalent to the DEFault parameter used in the command sub-systems. The parameters must be entered in the specified order. If parameters are omitted, they will default from the right. The parameter DEFault is used as a place holder. Specifying DEF leaves the parameter value unchanged.
2. When the measurement result is linear this parameter represents the number of significant digits. When the measurement result is logarithmic 1 to 4 represents a resolution of 1, 0.1, 0.01 and 0.001 respectively.
3. E4417A only.

Example

```
CONF1:DIFF:REL DEF,1,(@1),(@2)
```

This command configures the upper window to make a difference measurement of channel A - channel B with relative mode on, using the current sensor range and a resolution of 1 on both channels.

CONFigure[1]2|3|4[:SCALar][:POWer:AC]:RATio [<expected_value>[,<resolution>[,<source list>]]]

CONFigure[1]2|3|4[:SCALar][:POWer:AC]:RATio
[<expected_value>[,<resolution>[,<source list>]]]

This command sets the measurement function, range and resolution of the specified window. It sets the measurement function to ratio with relative mode off.

Syntax

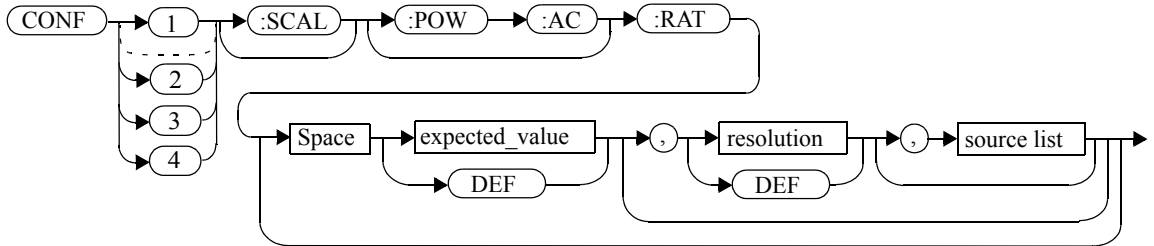

Parameters

Refer to “Optional Parameters”, on page 2-3 for additional details on the parameters in this command.

Item	Description/Default	Range of Values
expected_value (for the expected power level)	The power meter ignores the numeric value entered in this parameter. Any value entered is treated like DEF.	sensor dependent DEF ¹
resolution	A numeric value for the resolution. If unspecified the current resolution setting is used.	1 to 4 ² 1.0, 0.1, 0.01, 0.001 DEF ¹
source list	This channel list specifies the channels used to calculate the ratio. If unspecified and the current window setup is a ratio measurement then this ratio setup is used, otherwise it defaults to channel A/B (E4417A) or A/A (E4416A).	(@1),(@2) ³ (@2),(@1) ³ (@1),(@1) (@2),(@2) ³

1. The mnemonic DEF means DEFault. This is not equivalent to the DEFault parameter used in the command sub-systems. The parameters must be entered in the specified order. If parameters are omitted, they will default from the right. The parameter DEFault is used as a place holder. Specifying DEF leaves the parameter value unchanged.

CONFigure[1]|2|3|4[:SCALar][:POWer:AC]:RATio [<expected_value>[,<resolution>[,<source list>]]]

2. When the measurement result is linear this parameter represents the number of significant digits. When the measurement result is logarithmic 1 to 4 represents a resolution of 1, 0.1, 0.01 and 0.001 respectively.
3. E4417A only.

Example

```
CONF1:RAT DEF, 4, (@1), (@2)
```

This command configures the upper window to make a ratio measurement of channel A over channel B, using the current sensor range and a resolution setting of 4 on both channels.

CONFFigure[1]|2|3|4[:SCALar][:POWer:AC]:RATio:RELative [<expected_value>[,<resolution>[,<source list>]]]

CONFFigure[1]|2|3|4[:SCALar][:POWer:AC]:RATio:RELative
[<expected_value>[,<resolution>[,<source list>]]]

This command sets the measurement function, range and resolution of the specified window. It sets the measurement function to ratio with relative mode on. The relative value used is that set by the CALCulate:RELative:MAGNitude:AUTO command.

Syntax

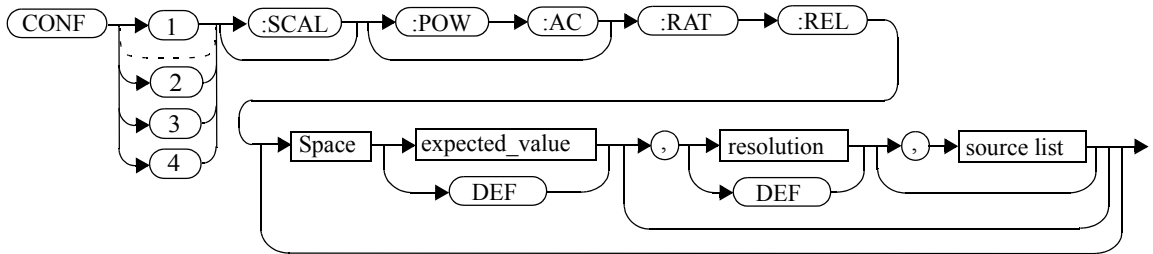

Parameters

Refer to “Optional Parameters”, on page 2-3 for additional details on the parameters in this command.

Item	Description/Default	Range of Values
expected_value (for the expected power level)	The power meter ignores the numeric value entered in this parameter. Any value entered is treated like DEF.	sensor dependent DEF ¹
resolution	A numeric value for the resolution. If unspecified the current resolution setting is used.	1 to 4 ² 1.0, 0.1, 0.01, 0.001 DEF ¹
source list	This channel list specifies the channels used to calculate the ratio. If unspecified and the current window setup is a ratio measurement then this ratio setup is used, otherwise it defaults to channel A/B (E4417A) or A/A (E4416A).	(@1),(@2) ³ (@2),(@1) ³ (@1),(@1) (@2),(@2) ³

CONFigure[1][2][3][4[:SCALar][:POWer:AC]:RATio:RELative [<expected_value>[,<resolution>[,<source list>]]]

1. The mnemonic DEF means DEFault. This is not equivalent to the DEFault parameter used in the command sub-systems. The parameters must be entered in the specified order. If parameters are omitted, they will default from the right. The parameter DEFault is used as a place holder. Specifying DEF leaves the parameter value unchanged.
2. When the measurement result is linear this parameter represents the number of significant digits. When the measurement result is logarithmic 1 to 4 represents a resolution of 1, 0.1, 0.01 and 0.001 respectively.
3. E4417A only.

Example

```
CONF1 : RAT : REL DEF , 1 , (@1) , (@2)
```

This command configures the upper window to make a ratio measurement of channel A over channel B with relative mode on, using the current sensor range and a resolution setting of 1 on both channels.

FETCh[1]|2|3|4 Queries

The FETCh? queries set the specified window's measurement function to either single channel, difference or ratio measurements with relative mode either off or on. They then recalculate the measurement and place the result on the bus. The format of the result is set by FORM [:READ] [:DATA]. Refer to chapter 6, Format, for further information.

The query returns a measurement result whenever it is valid. The measurement result becomes invalid under the following conditions:

- When *RST is executed.
- Whenever a measurement is initiated.
- When any SENSE parameter, such as frequency, is changed.

If data is invalid, the FETCh? query is not completed until all data is valid. The exceptions to this are, if the power meter is in the idle state and the data is invalid, or the power meter has been reconfigured as defined above and no new measurement has been initiated. In such cases, the FETCh? routine generates the error -230, "Data corrupt or stale" and no result is returned. A common cause for this error is receiving a FETCh? after a *RST. If the expected value and resolution parameters are not the same as those that were used to collect the data, error -221, "Settings conflict" occurs.

Note

When TRIG:SOUR is INT1, INT2 or EXT and a new acquisition has been initiated (using the INIT command for example), FETCh? waits until the trigger takes place before executing. If trigger conditions are not satisfied—when the trigger level differs greatly from the signal level for example—this can give the impression that the power meter has hung.

To 'unlock' the power meter and adjust trigger settings, a GPIB bus execute clear must be performed.

FETCh[1]|2|3|4[:SCALar][:POWer:AC]? [<expected_value>[,<resolution>[,<source list>]]]

FETCh[1]|2|3|4[:SCALar][:POWer:AC]? [<expected_value>[,<resolution>[,<source list>]]]

This command sets the specified window’s measurement function to single channel with relative mode off, recalculates the measurement and places the result on the bus. The result is a power based measurement and is expressed in the units defined by UNIT [1] | 2 | 3 | 4 : POWer.

Syntax

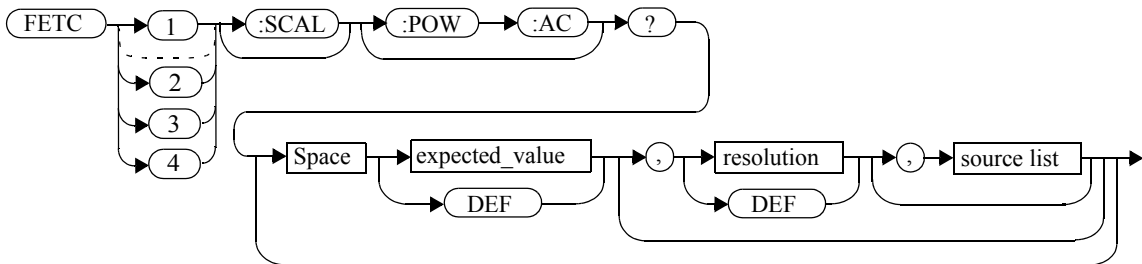

Parameters

Refer to “Optional Parameters”, on page 2-3 for additional details on the parameters in this command.

Item	Description/Default	Range of Values
expected_value (for the expected power level)	The expected power level parameter can be set to DEF or a numeric value. If a value is entered it should correspond to that set by CONFIGure otherwise an error occurs. The units of measurement are dBm and W. The default units are defined by UNIT : POWer.	sensor dependent DEF ¹
resolution	A numeric value for the resolution. If it is unspecified the current resolution setting is used. If a value is entered it should correspond to the current resolution setting otherwise an error occurs.	1 to 4 ² 1.0, 0.1, 0.01, 0.001 DEF ¹

FETCh[1][2][3][4[:SCALar][:POWer:AC]? [<expected_value>[,<resolution>[,<source list>]]]

Item	Description/Default	Range of Values
source list	The channel which the command is implemented on. If unspecified the current window setup is used. However, on the E4417A, if the window shows a ratio or difference measurement, the upper window defaults to channel A and the lower window to channel B.	(@1) (@2) (E4417A only)

1. The mnemonic DEF means DEFault. This is not equivalent to the DEFault parameter used in the command sub-systems. The parameters must be entered in the specified order. If parameters are omitted, they will default from the right. The parameter DEFault is used as a place holder. Specifying DEF leaves the parameter value unchanged.

2. When the measurement result is linear this parameter represents the number of significant digits. When the measurement result is logarithmic 1 to 4 represents a resolution of 1, 0.1, 0.01 and 0.001 respectively.

Example

FETC2 : POW : AC ?

This command queries the lower window's measurement result.

Error Messages

- If the last measurement is not valid error -230, "Data corrupt or stale" occurs. A measurement is valid after it has been initiated. It becomes invalid when either a reset occurs or any measurement parameter, for example frequency, is changed.
- If the expected_value and resolution parameters are not the same as the current expected value and resolution setting on the specified window, error -221, "Settings conflict" occurs.

FETCh[1]|2|3|4[:SCALar][:POWer:AC]:RELative? [<expected_value>,<resolution>,<source list>]]

**FETCh[1]|2|3|4[:SCALar][:POWer:AC]:RELative?
[<expected_value>,<resolution>,<source list>]]**

This command sets the specified window’s measurement function to single channel with relative mode on, recalculates the measurement and places the results on the bus. The result is a ratio based measurement and is expressed in the units defined by UNIT[1] | 2 | 3 | 4 : POWER : RATIo. The relative value used is that set by the CALCulate:RELative:MAGNitude:AUTO command.

Syntax

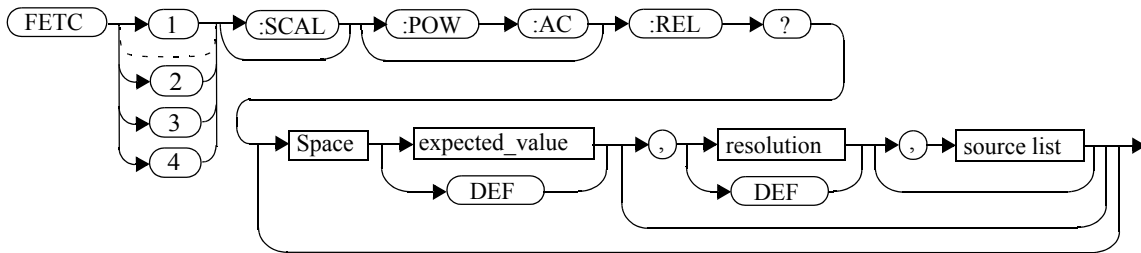

Parameters

Refer to “Optional Parameters”, on page 2-3 for additional details on the parameters in this command.

Item	Description/Default	Range of Values
expected_value (for the expected power level)	The expected power level parameter can be set to DEF or a numeric value. If a value is entered it should correspond to that set by CONFigure otherwise an error occurs. The units of measurement are dBm and W. The default units are defined by UNIT:POWer.	sensor dependent DEF ¹
resolution	A numeric value for the resolution. If it is unspecified the current resolution setting is used. If a value is entered it should correspond to the current resolution setting otherwise an error occurs.	1 to 4 ² 1.0, 0.1, 0.01, 0.001 DEF ¹

FETCh[1][2][3][4][:SCALar][:POWer:AC]:RELative? [<expected_value>[,<resolution>[,<source list>]]]

Item	Description/Default	Range of Values
source list	The channel which the command is implemented on. If unspecified the current window setup is used. However, on the E4417A, if the window shows a ratio or difference measurement, the upper window defaults to channel A and the lower window to channel B.	(@1) (@2) (E4417A only)

1. The mnemonic DEF means DEFault. This is not equivalent to the DEFault parameter used in the command sub-systems. The parameters must be entered in the specified order. If parameters are omitted, they will default from the right. The parameter DEFault is used as a place holder. Specifying DEF leaves the parameter value unchanged.

2. When the measurement result is linear this parameter represents the number of significant digits. When the measurement result is logarithmic 1 to 4 represents a resolution of 1, 0.1, 0.01 and 0.001 respectively.

Example

```
FETC1:REL? DEF,2,(@2)
```

This command queries the upper window's relative measurement of channel B, using the current sensor range and a resolution setting of 2.

FEtCh[1][2][3][4[:SCALAr][:POWer:AC]:RELative? [<expected_value>[,<resolution>[,<source list>]]]

Error Messages

- If the last measurement is not valid error -230, “Data corrupt or stale” occurs. A measurement is valid after it has been initiated. It becomes invalid when either a reset occurs or any measurement parameter, for example frequency, is changed.
- If the expected_value and resolution parameters are not the same as the current expected value and resolution settings on the specified window, error -221, “Settings conflict” occurs.

FETCh[1]|2|3|4[:SCALar][:POWer:AC]:DIFFerence? [<expected_value>[,<resolution>[,<source list>]]]

FETCh[1]|2|3|4[:SCALar][:POWer:AC]:DIFFerence? [<expected_value>[,<resolution>[,<source list>]]]

This command sets the specified window's measurement function to power difference with relative mode off, recalculates the measurement and places the results on the bus. The result is a power based measurement and is expressed in the units defined by UNIT[1] | 2 | 3 | 4 : POWer.

Syntax

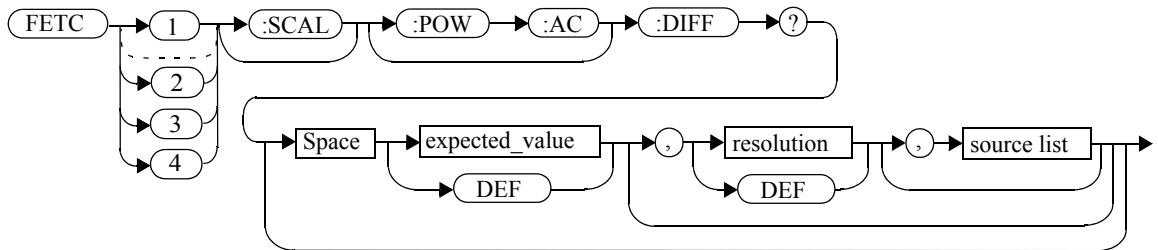

Parameters

Refer to “Optional Parameters”, on page 2-3 for additional details on the parameters in this command.

Item	Description/Default	Range of Values
expected_value (for the expected power level)	The expected power level parameter can be set to DEF or a numeric value. If a value is entered it should correspond to that set by CONFIGure otherwise an error occurs. The units of measurement are dBm and W. The default units are defined by UNIT: POWer.	sensor dependent DEF ¹
resolution	A numeric value for the resolution. If it is unspecified the current resolution setting is used. If a value is entered it should correspond to the current resolution setting otherwise an error occurs.	1 to 4 ² 1.0, 0.1, 0.01, 0.001 DEF ¹

FETCH[1][2]3[4[:SCALAr][:POWER:AC]:DIFFerence? [<expected_value>,<resolution>,<source list>]]]

Item	Description/Default	Range of Values
source list	This channel list specifies the channels used to calculate the difference. If unspecified and the current window setup is a difference measurement then this difference setup is used, otherwise it defaults to channel A-B (E4417A) or A-A (E4416A).	(@1),(@2) ³ (@2),(@1) ³ (@1),(@1) (@2),(@2) ³

1. The mnemonic DEF means DEFault. This is not equivalent to the DEFault parameter used in the command sub-systems. The parameters must be entered in the specified order. If parameters are omitted, they will default from the right. The parameter DEFault is used as a place holder. Specifying DEF leaves the parameter value unchanged.

2. When the measurement result is linear this parameter represents the number of significant digits. When the measurement result is logarithmic 1 to 4 represents a resolution of 1, 0.1, 0.01 and 0.001 respectively.

3. E4417A only.

Example

FETC2 : DIFF?

This command queries the difference measurement on the lower window.

Error Messages

- If the last measurement on either channel is not valid error -230, “Data corrupt or stale” occurs. A measurement is valid after it has been initiated. It becomes invalid when either a reset occurs or any measurement parameter, for example frequency, is changed.
- If the expected_value and resolution parameters are not the same as the current expected value and resolution settings on the specified window, error -221, “Settings conflict” occurs.

FETCh[1]|2|3|4[:SCALar][:POWer:AC]:DIFFerence:RELative?
[<expected_value>[,<resolution>[,<source list>]]]

This command sets the specified window's measurement function to power difference with relative mode on, recalculates the measurement and places the results on the bus. The result is a ratio based measurement and is expressed in the units defined by `UNIT[1] | 2 | 3 | 4 : POWER : RATIo`. The relative value used is that set by the `CALCulate:RELative:MAGNitude:AUTO` command.

Syntax

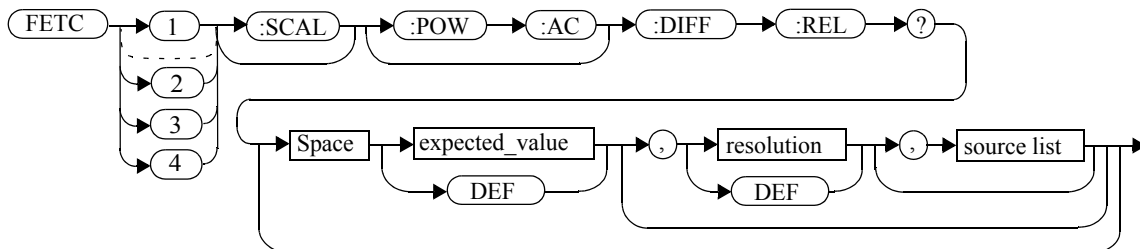

Parameters

Refer to “Optional Parameters”, on page 2-3 for additional details on the parameters in this command.

Item	Description/Default	Range of Values
expected_value (for the expected power level)	The expected power level parameter can be set to DEF or a numeric value. If a value is entered it should correspond to that set by CONFIGure otherwise an error occurs. The units of measurement are dBm and W. The default units are defined by UNIT: POWER.	sensor dependent DEF ¹
resolution	A numeric value for the resolution. If it is unspecified the current resolution setting is used. If a value is entered it should correspond to the current resolution setting otherwise an error occurs.	1 to 4 ² 1.0, 0.1, 0.01, 0.001 DEF ¹

FETCH[1][2][3][4][:SCALar][:POWer:AC]:DIFFerence:RELative?**[<expected_value>[,<resolution>[,<source list>]]]**

Item	Description/Default	Range of Values
source list	This channel list specifies the channels used to calculate the difference. If unspecified and the current window setup is a difference measurement then this difference setup is used, otherwise it defaults to channel A-B (E4417A) or A-A (E4416A).	(@1),(@2) ³ (@2),(@1) ³ (@1),(@1) (@2),(@2) ³

1. The mnemonic DEF means DEFault. This is not equivalent to the DEFault parameter used in the command sub-systems. The parameters must be entered in the specified order. If parameters are omitted, they will default from the right. The parameter DEFault is used as a place holder. Specifying DEF leaves the parameter value unchanged.

2. When the measurement result is linear this parameter represents the number of significant digits. When the measurement result is logarithmic 1 to 4 represents a resolution of 1, 0.1, 0.01 and 0.001 respectively.

3. E4417A only.

Example

```
FETC1:DIFF:REL? DEF,3,(@2),(@1)
```

This command queries the upper window's relative difference measurement of channel B - channel A, using the current sensor range and a resolution setting of 3 on both channels.

Error Messages

- If the last measurement on either channel is not valid error -230, "Data corrupt or stale" occurs. A measurement is valid after it has been initiated. It becomes invalid when either a reset occurs or any measurement parameter, for example frequency, is changed.
- If the expected_value and resolution parameters are not the same as the current expected value and resolution settings on the specified window, error -221, "Settings conflict" occurs.

FETCh[1]|2|3|4[:SCALar][:POWER:AC]:RATio? [<expected_value>[,<resolution>[,<source list>]]]

FETCh[1]|2|3|4[:SCALar][:POWER:AC]:RATio?

[<expected_value>[,<resolution>[,<source list>]]]

This command sets the specified window's measurement function to power ratio with relative mode off, recalculates the measurement and places the results on the bus. The result is a ratio based measurement and is expressed in the units defined by UNIT[1] | 2 | 3 | 4 : POWER : RATio.

Syntax

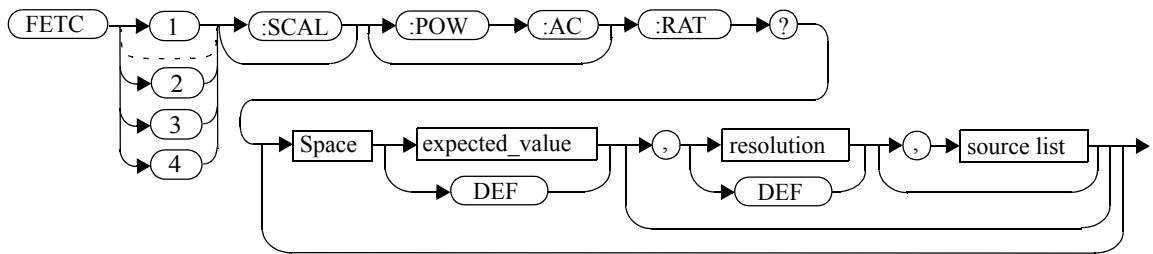

Parameters

Refer to “Optional Parameters”, on page 2-3 for additional details on the parameters in this command.

Item	Description/Default	Range of Values
expected_value (for the expected power level)	The expected power level parameter can be set to DEF or a numeric value. If a value is entered it should correspond to that set by CONFIGure otherwise an error occurs. The units of measurement are dBm and W. The default units are defined by UNIT:POWER.	sensor dependent DEF ¹
resolution	A numeric value for the resolution. If it is unspecified the current resolution setting is used. If a value is entered it should correspond to the current resolution setting otherwise an error occurs.	1 to 4 ² 1.0, 0.1, 0.01, 0.001 DEF ¹

FETCh[1][2][3][4[:SCALAr][:POWER:AC]:RATio? [<expected_value>,<resolution>,<source list>]]

Item	Description/Default	Range of Values
source list	This channel list specifies the channels used to calculate the ratio. If unspecified and the current window setup is a ratio measurement then this ratio setup is used, otherwise it defaults to channel A/B (E4417A) or A/A (E4416A).	(@1),(@2) ³ (@2),(@1) ³ (@1),(@1) (@2),(@2) ³

1. The mnemonic DEF means DEFault. This is not equivalent to the DEFault parameter used in the command sub-systems. The parameters must be entered in the specified order. If parameters are omitted, they will default from the right. The parameter DEFault is used as a place holder. Specifying DEF leaves the parameter value unchanged.

2. When the measurement result is linear this parameter represents the number of significant digits. When the measurement result is logarithmic 1 to 4 represents a resolution of 1, 0.1, 0.01 and 0.001 respectively.

3. E4417A only.

Example

```
FETC2:RAT? DEF,1,(@1),(@2)
```

This command queries the lower window's ratio measurement of channel A over channel B, using the current sensor range and a resolution of 1 on both channels.

Error Messages

- If the last measurement on either channel is not valid error -230, "Data corrupt or stale" occurs. A measurement is valid after it has been initiated. It becomes invalid when either a reset occurs or any measurement parameter, for example frequency, is changed.
- If the expected_value and resolution parameters are not the same as the current expected value and resolution settings on the specified window, error -221, "Settings conflict" occurs.

FETCh[1]|2|3|4[:SCALar][:POWER:AC]:RATio:RELative? [<expected_value>[,<resolution>[,<source list>]]]

**FETCh[1]|2|3|4[:SCALar][:POWER:AC]:RATio:RELative?
[<expected_value>[,<resolution>[,<source list>]]]**

This command sets the specified window's measurement function to power ratio with relative mode on, recalculates the measurement and places the results on the bus. The result is a ratio based measurement and is expressed in the units defined by `UNIT[1]|2|3|4:POWER:RATio`. The relative value used is that set by the `CALCulate:RELative:MAGNitude:AUTO` command.

Syntax

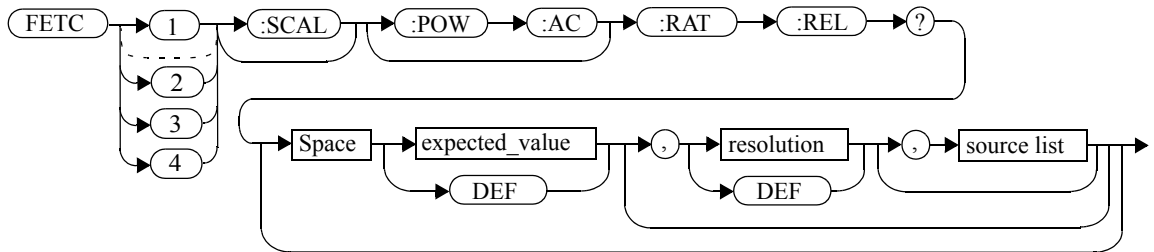

Parameters

Refer to “Optional Parameters”, on page 2-3 for additional details on the parameters in this command.

Item	Description/Default	Range of Values
expected_value (for the expected power level)	The expected power level parameter can be set to <code>DEF</code> or a numeric value. If a value is entered it should correspond to that set by <code>CONFigure</code> otherwise an error occurs. The units of measurement are dBm and W. The default units are defined by <code>UNIT:POWER</code> .	sensor dependent <code>DEF</code> ¹
resolution	A numeric value for the resolution. If it is unspecified the current resolution setting is used. If a value is entered it should correspond to the current resolution setting otherwise an error occurs.	<code>1 to 4</code> ² <code>1.0, 0.1, 0.01, 0.001</code> <code>DEF</code> ¹

FETCH[1][2][3][4[:SCALar][:POWER:AC]:RATio:RELative? [<expected_value>[,<resolution>[,<source list>]]]

Item	Description/Default	Range of Values
source list	This channel list specifies the channels used to calculate the ratio. If unspecified and the current window setup is a ratio measurement then this ratio setup is used, otherwise it defaults to channel A/B (E4417A) or A/A (E4416A).	(@1),(@2) ³ (@2),(@1) ³ (@1),(@1) (@2),(@2) ³

1. The mnemonic DEF means DEFault. This is not equivalent to the DEFault parameter used in the command sub-systems. The parameters must be entered in the specified order. If parameters are omitted, they will default from the right. The parameter DEFault is used as a place holder. Specifying DEF leaves the parameter value unchanged.

2. When the measurement result is linear this parameter represents the number of significant digits. When the measurement result is logarithmic 1 to 4 represents a resolution of 1, 0.1, 0.01 and 0.001 respectively.

3. E4417A only.

Example

`FETC : RAT : REL ?` *This command queries the relative ratio measurement on the upper window.*

Error Messages

- If the last measurement on either channel is not valid error -230, “Data corrupt or stale” occurs. A measurement is valid after it has been initiated. It becomes invalid when either a reset occurs or any measurement parameter, for example frequency, is changed.
- If the expected_value and resolution parameters are not the same as the current expected value and resolution settings on the specified window, error -221, “Settings conflict” occurs.

READ[1]|2|3|4 Commands

The READ? commands are most commonly used with the CONFIGure command to cause a new power measurement to be taken and the result returned to the output buffer. The format of the result is set by FORM [:READ] [:DATA] . Refer to chapter 6, Format, for further information.

- For the E4416A the READ? query is equivalent to:
 ABORt
 INITiate
 FETCh?
- For the E4417A carrying out a single channel measurement the READ? queries are equivalent to:
 ABORt1
 INITiate1
 FETCh1?

or

- For the E4417A carrying out a single channel measurement the READ? queries are equivalent to:
 ABORt2
 INITiate2
 FETCh2?
- For the E4417A carrying out a difference measurement the READ:DIFFerence? queries are equivalent to:
 ABORt1and
 ABORt2
 INITiate1
 INITiate2
 FETCh:DIFFerence?
- For the E4417A carrying out a ratio measurement the READ:RATio? queries are equivalent to:
 ABORt1
 ABORt2
 INITiate1
 INITiate2
 FETCh:RATio?

READ[1]|2|3|4[:SCALar][:POWer:AC]? [<expected_value>[,<resolution>[,<source list>]]]

READ[1]|2|3|4[:SCALar][:POWer:AC]? [<expected_value>[,<resolution>[,<source list>]]]

This command sets the specified window's measurement function to single channel with relative mode off, aborts then initiates the specified channel, calculates the measurement result and places the result on the bus. The result is a power based measurement and is expressed in the units defined by `UNIT [1] | 2 | 3 | 4 : POWer`.

Note

`INITiate:CONTINuous` must be set to `OFF`, otherwise error -213, "INIT ignored" occurs. If `TRIGger:SOURce` is set to `BUS`, error -214, "Trigger deadlock" occurs.

Syntax

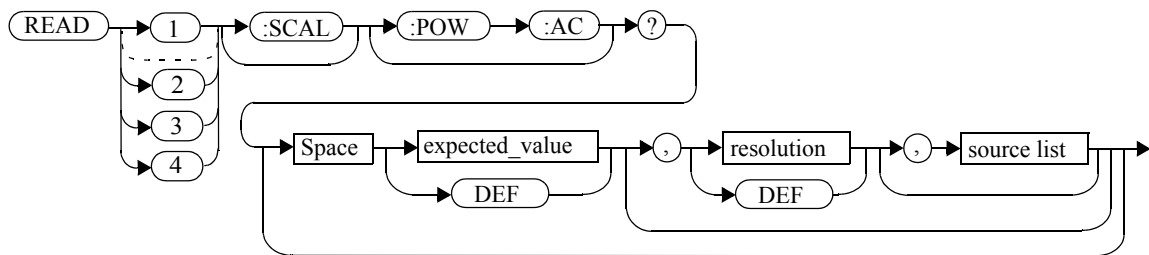

Parameters

Refer to "Optional Parameters", on page 2-3 for additional details on the parameters in this command.

Item	Description/Default	Range of Values
expected_value (for the expected power level)	The expected power level parameter can be set to <code>DEF</code> or a numeric value. If a value is entered it should correspond to that set by <code>CONFigure</code> otherwise an error occurs.	sensor dependent <code>DEF</code> ¹
resolution	A numeric value for the resolution. If it is unspecified the current resolution setting is used. If a value is entered it should correspond to the current resolution setting otherwise an error occurs.	1 to 4 ² 1.0, 0.1, 0.01, 0.001 <code>DEF</code> ¹

READ[1]|2|3|4[:SCALar][:POWer:AC]? [<expected_value>[,<resolution>[,<source list>]]]

Item	Description/Default	Range of Values
source list	The channel which the command is implemented on. If unspecified the current window setup is used. However, on the E4417A, if the window shows a ratio or difference measurement, the upper window defaults to channel A and the lower window to channel B.	(@1) (@2) (E4417A only)

1. The mnemonic DEF means DEFault. This is not equivalent to the DEFault parameter used in the command sub-systems. The parameters must be entered in the specified order. If parameters are omitted, they will default from the right. The parameter DEFault is used as a place holder. Specifying DEF leaves the parameter value unchanged.

2. When the measurement result is linear this parameter represents the number of significant digits. When the measurement result is logarithmic 1 to 4 represents a resolution of 1, 0.1, 0.01 and 0.001 respectively.

Example

READ2 : POW : AC ?

This command queries the lower window's measurement.

Error Messages

- INITiate:CONTinuous must be set to OFF, otherwise error -213, "INIT ignored" occurs.
- If TRIGger:SOURce is set to BUS or HOLD, error -214, "Trigger deadlock" occurs.
- If the expected value and resolution parameters are not the same as the current expected value and resolution settings on the specified window, error -221, "Settings conflict" occurs.

READ[1]|2|3|4[:SCALar][:POWer:AC]:RELative? [<expected_value>,<resolution>,<source list>]]]

**READ[1]|2|3|4[:SCALar][:POWer:AC]:RELative?
[<expected_value>,<resolution>,<source list>]]]**

This command sets the specified window's measurement function to single channel with relative mode on, aborts then initiates the specified channel, calculates the measurement result and places the result on the bus. The result is a ratio based measurement and is expressed in the units defined by UNIT[1] | 2 | 3 | 4 : POWER : RATio. The relative value used is that set by the CALCulate:RELative:MAGNitude:AUTO command.

Note INITiate:CONTinuous must be set to OFF, otherwise error -213, "INIT ignored" occurs. If TRIGger:SOURce is set to BUS, error -214, "Trigger deadlock" occurs.

Syntax

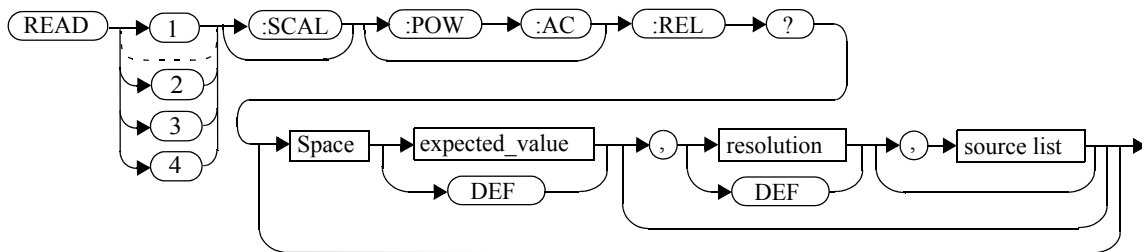

Parameters

Refer to "Optional Parameters", on page 2-3 for additional details on the parameters in this command.

Item	Description/Default	Range of Values
expected_value (for the expected power level)	The expected power level parameter can be set to DEF or a numeric value. If a value is entered it should correspond to that set by CONFigure otherwise an error occurs.	sensor dependent DEF ¹

READ[1]2|3|4[:SCALar][:POWER:AC]:RELative? [<expected_value>[,<resolution>[,<source list>]]]

Item	Description/Default	Range of Values
resolution	A numeric value for the resolution. If it is unspecified the current resolution setting is used. If a value is entered it should correspond to the current resolution setting otherwise an error occurs.	1 to 4 ² 1.0, 0.1, 0.01, 0.001 DEF ¹
source list	The channel which the command is implemented on. If unspecified the current window setup is used. However, on the E4417A, if the window shows a ratio or difference measurement, the upper window defaults to channel A and the lower window to channel B.	(@1) (@2) (E4417A only)

1. The mnemonic DEF means DEFault. This is not equivalent to the DEFault parameter used in the command sub-systems. The parameters must be entered in the specified order. If parameters are omitted, they will default from the right. The parameter DEFault is used as a place holder. Specifying DEF leaves the parameter value unchanged.

2. When the measurement result is linear this parameter represents the number of significant digits. When the measurement result is logarithmic 1 to 4 represents a resolution of 1, 0.1, 0.01 and 0.001 respectively.

Example

```
READ1:REL? DEF,1,(@2)
```

This command queries the upper window's relative measurement of channel B, using the current sensor range and a resolution of 1.

READ[1][2|3|4[:SCALAr][:POWer:AC]:RELative? [<expected_value>,<resolution>,<source list>]]]

Error Messages

- INITiate:CONTinuous must be set to OFF, otherwise error -213, “INIT ignored” occurs.
- If TRIGger:SOURce is set to BUS or HOLD, error -214, “Trigger deadlock” occurs.
- If the expected value and resolution parameters are not the same as the current expected value and resolution settings on the specified window, error -221, “Settings conflict” occurs.

READ[1]|2|3|4[:SCALar][:POWer:AC]:DIFFerence? [<expected_value>[,<resolution>[,<source list>]]]

**READ[1]|2|3|4[:SCALar][:POWer:AC]:DIFFerence?
[<expected_value>[,<resolution>[,<source list>]]]**

This command sets the specified window's measurement function to difference mode with relative mode off, aborts then initiates both channel A and B, calculates the difference measurement result and places the result on the bus. The result is a power based measurement and is expressed in the units defined by UNIT[1] | 2 | 3 | 4 : POWer.

Note INITiate:CONTinuous must be set to OFF on both channels, otherwise error -213, "INIT ignored" occurs. If TRIGger:SOURce is set to BUS on either channel, error -214, "Trigger deadlock" occurs.

Syntax

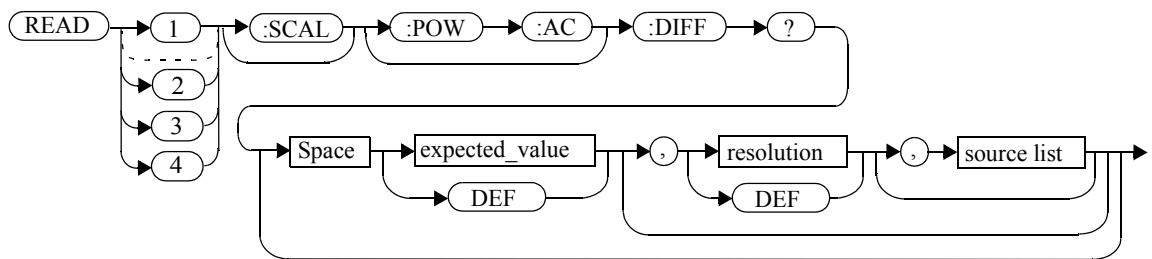

Parameters

Refer to "Optional Parameters", on page 2-3 for additional details on the parameters in this command.

Item	Description/Default	Range of Values
expected_value (for the expected power level)	The power meter ignores the numeric value entered in this parameter. Any value entered is treated like DEF.	sensor dependent DEF ¹
resolution	A numeric value for the resolution. If it is unspecified the current resolution setting is used. If a value is entered it should correspond to the current resolution setting otherwise an error occurs.	1 to 4 ² 1.0, 0.1, 0.01, 0.001 DEF ¹

READ[1][2][3][4[:SCALar][:POWer:AC]:DIFFerence? [<expected_value>[,<resolution>[,<source list>]]]

Item	Description/Default	Range of Values
source list	This channel list specifies the channels used to calculate the difference. If unspecified and the current window setup is a difference measurement then this difference setup is used, otherwise it defaults to channel A-B (E4417A) or A-A (E4416A).	(@1),(@2) ³ (@2),(@1) ³ (@1),(@1) (@2),(@2) ³

1. The mnemonic DEF means DEFault. This is not equivalent to the DEFault parameter used in the command sub-systems. The parameters must be entered in the specified order. If parameters are omitted, they will default from the right. The parameter DEFault is used as a place holder. Specifying DEF leaves the parameter value unchanged.

2. When the measurement result is linear this parameter represents the number of significant digits. When the measurement result is logarithmic 1 to 4 represents a resolution of 1, 0.1, 0.01 and 0.001 respectively.

3. E4417A only.

Example

READ2 : DIFF?

This command queries difference measurement on the lower window.

Error Messages

- INITiate:CONTInuous must be set to OFF on both channels, otherwise error -213, “INIT ignored” occurs.
- If TRIGger : SOURce is set to BUS or HOLD on either channel, error -214, “Trigger deadlock” occurs.
- If the resolution parameter is not the same as the current resolution setting on the specified window, error -221, “Settings conflict” occurs.

READ[1]|2|3|4[:SCALar][:POWer:AC]:DIFFerence:RELative?
[<expected_value>[,<resolution>[,<source list>]]]

This command sets the specified window's measurement function to difference mode with relative mode on, aborts then initiates both channel A and B, calculates the difference measurement result and places the result on the bus. The result is a ratio based measurement and is expressed in the units defined by `UNIT[1] | 2 | 3 | 4 : POWER : RATio`. The relative value used is that set by the `CALCulate:RELative:MAGNitude:AUTO` command.

Note `INITiate:CONTinuous` must be set to OFF on both channels, otherwise error -213, "INIT ignored" occurs. If `TRIGger:SOURce` is set to BUS on either channel, error -214, "Trigger deadlock" occurs.

Syntax

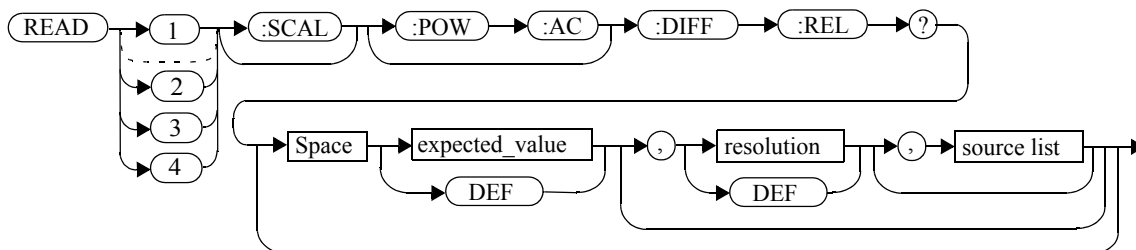

Parameters

Refer to "Optional Parameters", on page 2-3 for additional details on the parameters in this command.

Item	Description/Default	Range of Values
expected_value (for the expected power level)	The power meter ignores the numeric value entered in this parameter. Any value entered is treated like DEF.	sensor dependent DEF ¹
resolution	A numeric value for the resolution. If it is unspecified the current resolution setting is used. If a value is entered it should correspond to the current resolution setting otherwise an error occurs.	1 to 4 ² 1.0, 0.1, 0.01, 0.001 DEF ¹

**READ[1][2][3][4[:SCALAr][:POWer:AC]:DIFFerence:RELative?
[<expected_value>[,<resolution>[,<source list>]]]**

Item	Description/Default	Range of Values
source list	This channel list specifies the channels used to calculate the difference. If unspecified and the current window setup is a difference measurement then this difference setup is used, otherwise it defaults to channel A-B (E4417A) or A-A (E4416A).	(@1),(@2) ³ (@2),(@1) ³ (@1),(@1) (@2),(@2) ³

1. The mnemonic DEF means DEFault. This is not equivalent to the DEFault parameter used in the command sub-systems. The parameters must be entered in the specified order. If parameters are omitted, they will default from the right. The parameter DEFault is used as a place holder. Specifying DEF leaves the parameter value unchanged.

2. When the measurement result is linear this parameter represents the number of significant digits. When the measurement result is logarithmic 1 to 4 represents a resolution of 1, 0.1, 0.01 and 0.001 respectively.

3. E4417A only.

Example

`READ1:DIFF:REL? DEF,4,(@2),(@1)` *This command queries the upper window's relative difference measurement of channel B - channel A, using the current sensor range and a resolution setting of 4 on both channels.*

Error Messages

- INITiate:CONTInuous must be set to OFF on both channels, otherwise error -213, "INIT ignored" occurs.
- If TRIGger:SOURce is set to BUS or HOLD on either channel, error -214, "Trigger deadlock" occurs.
- If the resolution parameter is not the same as the current resolution setting on the specified window, error -221, "Settings conflict" occurs.

READ[1]|2|3|4[:SCALar][:POWER:AC]:RATio? [<expected_value>[,<resolution>[,<source list>]]]

READ[1]|2|3|4[:SCALar][:POWER:AC]:RATio? [<expected_value>[,<resolution>[,<source list>]]]

This command sets the specified window's measurement function to ratio mode with relative mode off, aborts then initiates both channel A and B, calculates the ratio measurement result and places the result on the bus. The result is a ratio based measurement and is expressed in the units defined by `UNIT[1] | 2 | 3 | 4 : POWER : RATio`.

Note `INITiate:CONTinuous` must be set to `OFF` on both channels, otherwise error -213, "INIT ignored" occurs. If `TRIGger:SOURce` is set to `BUS` on either channel, error -214, "Trigger deadlock" occurs.

Syntax

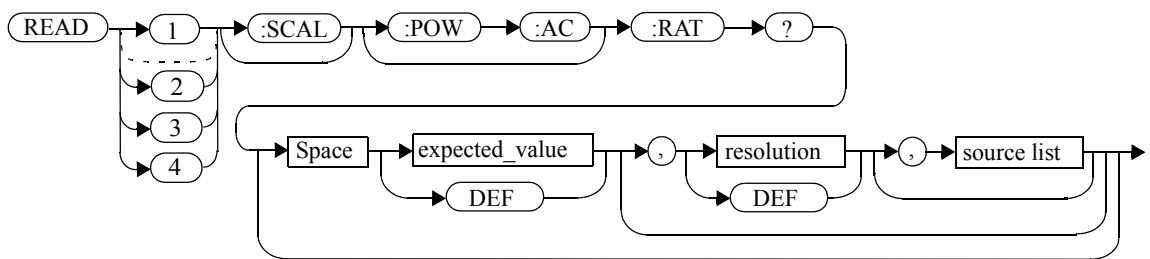

Parameters

Refer to "Optional Parameters", on page 2-3 for additional details on the parameters in this command.

Item	Description/Default	Range of Values
expected_value (for the expected power level)	The power meter ignores the numeric value entered in this parameter. Any value entered is treated like DEF.	sensor dependent DEF ¹
resolution	A numeric value for the resolution. If it is unspecified the current resolution setting is used. If a value is entered it should correspond to the current resolution setting otherwise an error occurs.	1 to 4 ² 1.0, 0.1, 0.01, 0.001 DEF ¹

READ[1]|2|3|4[:SCALAr][:POWer:AC]:RATio? [<expected_value>[,<resolution>[,<source list>]]]

Item	Description/Default	Range of Values
source list	This channel list specifies the channels used to calculate the ratio. If unspecified and the current window setup is a ratio measurement then this ratio setup is used, otherwise it defaults to channel A/B (E4417A) or A/A (E4416A).	(@1),(@2) ³ (@2),(@1) ³ (@1),(@1) (@2),(@2) ³

1. The mnemonic DEF means DEFault. This is not equivalent to the DEFault parameter used in the command sub-systems. The parameters must be entered in the specified order. If parameters are omitted, they will default from the right. The parameter DEFault is used as a place holder. Specifying DEF leaves the parameter value unchanged.

2. When the measurement result is linear this parameter represents the number of significant digits. When the measurement result is logarithmic 1 to 4 represents a resolution of 1, 0.1, 0.01 and 0.001 respectively.

3. E4417A only.

Example

```
READ2:RAT? DEF,1,(@1),(@2)
```

This command queries the lower window's ratio measurement of channel A over channel B, using the current sensor range and a resolution of 1 on both channels.

Error Messages

- INITiate:CONTinuous must be set to OFF on both channels, otherwise error -213, "INIT ignored" occurs.
- If TRIGger:SOURce is set to BUS or HOLD on either channel, error -214, "Trigger deadlock" occurs.
- If the resolution parameter is not the same as the current resolution setting on the specified window, error -221, "Settings conflict" occurs.

READ[1]|2|3|4[:SCALar][:POWer:AC]:RATio:RELative? [<expected_value>[,<resolution>[,<source list>]]]

**READ[1]|2|3|4[:SCALar][:POWer:AC]:RATio:RELative?
[<expected_value>[,<resolution>[,<source list>]]]**

This command sets the specified window's measurement function to ratio mode with relative mode on, aborts then initiates both channel A and B, calculates the ratio measurement result using the new sensor data and places the result on the bus. The result is a ratio based measurement and is expressed in the units defined by `UNIT[1] | 2 | 3 | 4 : POWER : RATio`. The relative value used is that set by the `CALCulate:RELative:MAGNitude:AUTO` command.

Note `INITiate:CONTinuous` must be set to OFF on both channels, otherwise error -213, "INIT ignored" occurs. If `TRIGger:SOURce` is set to BUS on either channel, error -214, "Trigger deadlock" occurs.

Syntax

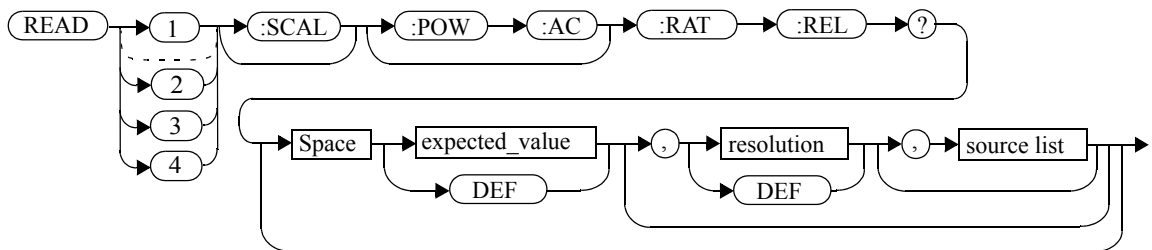

Parameters

Refer to "Optional Parameters", on page 2-3 for additional details on the parameters in this command.

Item	Description/Default	Range of Values
expected_value (for the expected power level)	The power meter ignores the numeric value entered in this parameter. Any value entered is treated like DEF.	sensor dependent DEF ¹
resolution	A numeric value for the resolution. If it is unspecified the current resolution setting is used. If a value is entered it should correspond to the current resolution setting otherwise an error occurs.	1 to 4 ² 1.0, 0.1, 0.01, 0.001 DEF ¹

READ[1][2][3][4[:SCALar][:POWer:AC]:RATio:RELative? [<expected_value>[,<resolution>[,<source list>]]]

Item	Description/Default	Range of Values
source list	This channel list specifies the channels used to calculate the ratio. If unspecified and the current window setup is a ratio measurement then this ratio setup is used, otherwise it defaults to channel A/B (E4417A) or A/A (E4416A).	(@1),(@2) ³ (@2),(@1) ³ (@1),(@1) (@2),(@2) ³

1. The mnemonic DEF means DEFault. This is not equivalent to the DEFault parameter used in the command sub-systems. The parameters must be entered in the specified order. If parameters are omitted, they will default from the right. The parameter DEFault is used as a place holder. Specifying DEF leaves the parameter value unchanged.

2. When the measurement result is linear this parameter represents the number of significant digits. When the measurement result is logarithmic 1 to 4 represents a resolution of 1, 0.1, 0.01 and 0.001 respectively.

3. E4417A only.

Example

```
READ:RAT:REL?
```

This command queries the relative ratio measurement on the upper window.

Error Messages

- INITiate:CONTinuous must be set to OFF on both channels, otherwise error -213, “INIT ignored” occurs.
- If TRIGger:SOURce is set to BUS or HOLD on either channel, error -214, “Trigger deadlock” occurs.
- If the resolution parameter is not the same as the current resolution setting on the specified window, error -221, “Settings conflict” occurs.

MEASure[1]|2|3|4 Commands

The MEASure? commands configure the power meter to perform a power measurement with the given measurement function, relative mode setting, range and resolution then makes the measurement. The format of the result is set by FORM[:READ][:DATA]. Refer to chapter 6, Format, for further information.

MEASure? is a compound command which is equivalent to:

- For the E4416A the MEASure? query is equivalent to:
 ABORt
 CONFIgure
 READ?
 - For the E4417A carrying out a single channel measurement the MEASure? queries are equivalent to:
 ABORt1
 CONFIgure
 READ1?
- or*
- For the E4417A carrying out a difference measurement the READ:DIFFerence? queries are equivalent to:
 ABORt1
 ABORt2
 CONFIgure:DIFFerence
 READ:DIFFerence?
 - For the E4417A carrying out a ratio measurement the READ:RATio? queries are equivalent to:
 ABORt1
 ABORt2
 CONFIgure:RATio
 READ:RATio?

MEASure[1]|2|3|4[:SCALar][:POWer:AC]? [<expected_value>[,<resolution>[,<source list>]]]

MEASure[1]|2|3|4[:SCALar][:POWer:AC]? [<expected_value>[,<resolution>[,<source list>]]]

This command sets the specified window’s measurement function to single channel with relative mode off, aborts, configures the window then initiates channel A or B, calculates the measurement result and places the result on the bus.

Syntax

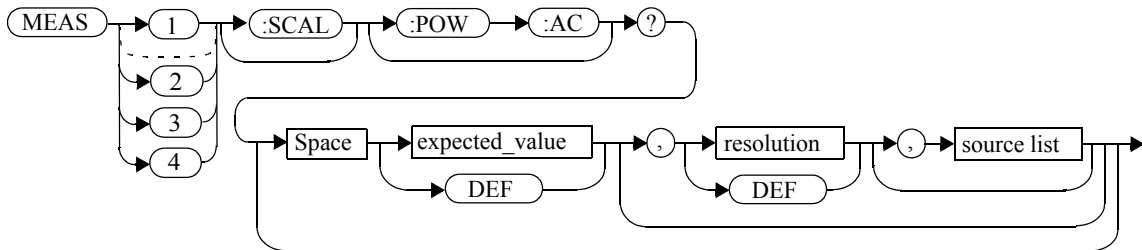

Parameters

Refer to “Optional Parameters”, on page 2-3 for additional details on the parameters in this command.

Item	Description/Default	Range of Values
expected_value (for the expected power level)	A numeric value for the expected power level. The units of measurement are dBm and W. The default units are defined by UNIT:POWer.	sensor dependent DEF ¹
resolution	A numeric value for the resolution. If unspecified the current resolution setting is used.	1 to 4 ² 1.0, 0.1, 0.01, 0.001 DEF ¹
source list	The channel which the command is implemented on. If unspecified the current window setup is used. However, on the E4417A, if the window shows a ratio or difference measurement, the upper window defaults to channel A and the lower window to channel B.	(@1) (@2) (E4417A only)

MEASure[1]|2|3|4[:SCALar][:POWer:AC]? [<expected_value>[,<resolution>[,<source list>]]]

1. The mnemonic DEF means DEFault. This is not equivalent to the DEFault parameter used in the command sub-systems. The parameters must be entered in the specified order. If parameters are omitted, they will default from the right. The parameter DEFault is used as a place holder. Specifying DEF leaves the parameter value unchanged.
2. When the measurement result is linear this parameter represents the number of significant digits. When the measurement result is logarithmic 1 to 4 represents a resolution of 1, 0.1, 0.01 and 0.001 respectively.

Example

MEAS2:POW:AC? -70DBM,1,(@1) *This command queries the lower window's measurement of channel A, using an expected power level of -70 dBm and a resolution setting of 1.*

MEASure[1]|2|3|4[:SCALar][:POWER:AC]:RELative? [<expected_value>,<resolution>,<source list>]]

MEASure[1]|2|3|4[:SCALar][:POWER:AC]:RELative? [<expected_value>,<resolution>,<source list>]]

This command sets the specified window’s measurement function to single channel with relative mode on, aborts, configures then initiates the specified channel, calculates the measurement result and places the result on the bus. The result is a ratio based measurement and is expressed in the units defined by UNIT[1] | 2 | 3 | 4 : POWER : RATio. The relative value used is that set by the CALCulate:RELative:MAGNitude:AUTO command.

Syntax

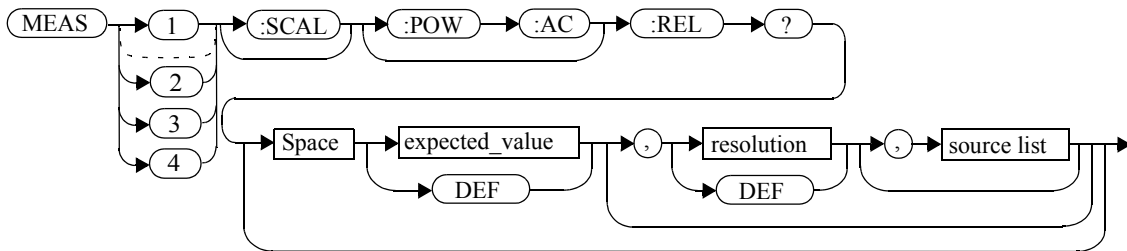

Parameters

Refer to “Optional Parameters”, on page 2-3 for additional details on the parameters in this command.

Item	Description/Default	Range of Values
expected_value (for the expected power level)	A numeric value for the expected power level. The units of measurement are dBm and W. The default units are defined by UNIT : POWER.	sensor dependent DEF ¹
resolution	A numeric value for the resolution. If unspecified the current resolution setting is used.	1 to 4 ² 1.0, 0.1, 0.01, 0.001 DEF ¹

MEASure[1][2][3][4]:SCALar[:POWER:AC]:RELative? [<expected_value>[,<resolution>[,<source list>]]]

Item	Description/Default	Range of Values
source list	The channel which the command is implemented on. If unspecified the current window setup is used. However, on the E4417A, if the window shows a ratio or difference measurement, the upper window defaults to channel A and the lower window to channel B.	(@1) (@2) (E4417A only)

1. The mnemonic DEF means DEFault. This is not equivalent to the DEFault parameter used in the command sub-systems. The parameters must be entered in the specified order. If parameters are omitted, they will default from the right. The parameter DEFault is used as a place holder. Specifying DEF leaves the parameter value unchanged.

2. When the measurement result is linear this parameter represents the number of significant digits. When the measurement result is logarithmic 1 to 4 represents a resolution of 1, 0.1, 0.01 and 0.001 respectively.

Example

MEAS1:REL? -50DBM, 2, (@2)

This command queries the upper window's relative measurement of channel B, using an expected power level of -50 dBm and a resolution setting of 2.

MEASure[1]|2|3|4[:SCALar][:POWER:AC]:DIFFerence? [<expected_value>[,<resolution>[,<source list>]]]

MEASure[1]|2|3|4[:SCALar][:POWER:AC]:DIFFerence? [<expected_value>[,<resolution>[,<source list>]]]

This command applies to the E4417A power meter only.

This command sets the specified window’s measurement function to difference mode with relative mode off, aborts, configures then initiates both channel A and B, calculates the difference measurement result and places the result on the bus. The result is a power based measurement and is expressed in the units defined by UNIT [1] | 2 | 3 | 4 : POWER.

Syntax

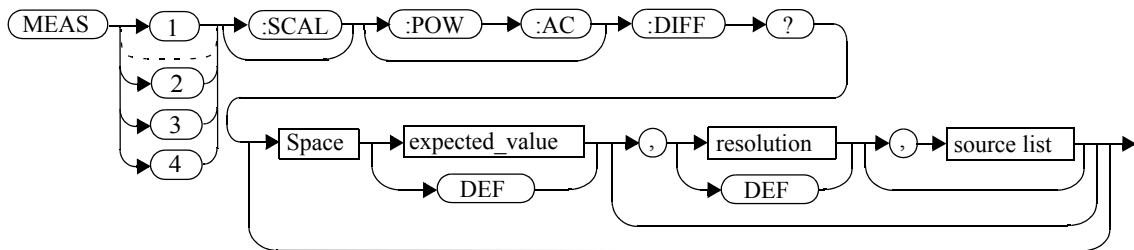

Parameters

Refer to “Optional Parameters”, on page 2-3 for additional details on the parameters in this command.

Item	Description/Default	Range of Values
expected_value (for the expected power level)	The power meter ignores the numeric value entered in this parameter. Any value entered is treated like DEF.	sensor dependent DEF ¹
resolution	A numeric value for the resolution. If unspecified the current resolution setting is used.	1 to 4 ² 1.0, 0.1, 0.01, 0.001 DEF ¹

MEASure[1][2|3|4[:SCALar][:POWer:AC]:DIFFerence? [<expected_value>[,<resolution>[,<source list>]]]

Item	Description/Default	Range of Values
source list	This channel list specifies the channels used to calculate the difference. If unspecified and the current window setup is a difference measurement then this difference setup is used, otherwise it defaults to channel A-B (E4417A) or A-A (E4416A).	(@1),(@2) ³ (@2),(@1) ³ (@1),(@1) (@2),(@2) ³

1. The mnemonic DEF means DEFault. This is not equivalent to the DEFault parameter used in the command sub-systems. The parameters must be entered in the specified order. If parameters are omitted, they will default from the right. The parameter DEFault is used as a place holder. Specifying DEF leaves the parameter value unchanged.

2. When the measurement result is linear this parameter represents the number of significant digits. When the measurement result is logarithmic 1 to 4 represents a resolution of 1, 0.1, 0.01 and 0.001 respectively.

3. E4417A only.

Example

MEAS2 : DIFF?

This command queries the difference measurement on the lower window.

MEASure[1]|2|3|4[:SCALar][:POWer:AC]:DIFFerence:RELative?

[<expected_value>[,<resolution>[,<source list>]]]

MEASure[1]|2|3|4[:SCALar][:POWer:AC]:DIFFerence:RELative?
[<expected_value>[,<resolution>[,<source list>]]]

This command sets the specified window's measurement function to difference mode with relative mode on, aborts, configures then initiates both channel A and B, calculates the difference measurement result and places the result on the bus. The result is a ratio based measurement and is expressed in the units defined by UNIT[1] | 2 | 3 | 4 : POWer : RATio. The relative value used is that set by the CALCulate:RELative:MAGNitude:AUTO command.

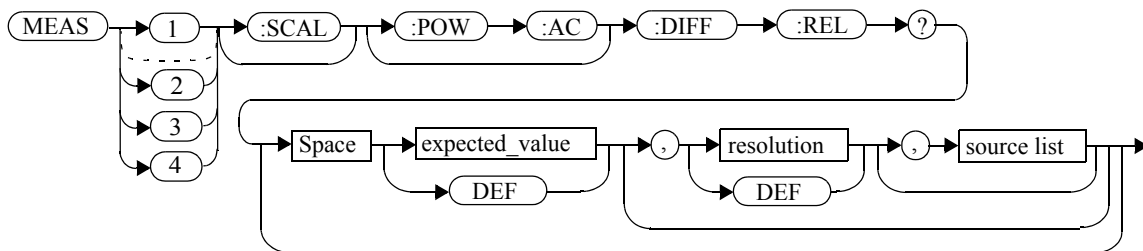
Syntax**Parameters**

Refer to “Optional Parameters”, on page 2-3 for additional details on the parameters in this command.

Item	Description/Default	Range of Values
expected_value (for the expected power level)	The power meter ignores the numeric value entered in this parameter. Any value entered is treated like DEF.	sensor dependent DEF ¹
resolution	A numeric value for the resolution. If unspecified the current resolution setting is used.	1 to 4 ² 1.0, 0.1, 0.01, 0.001 DEF ¹
source list	This channel list specifies the channels used to calculate the difference. If unspecified and the current window setup is a difference measurement then this difference setup is used, otherwise it defaults to channel A-B (E4417A) or A-A (E4416A).	(@1),(@2) ³ (@2),(@1) ³ (@1),(@1) (@2),(@2) ³

1. The mnemonic DEF means DEFault. This is not equivalent to the DEFault parameter used in the command sub-systems. The parameters must be entered in the specified order. If parameters are omitted, they will default from the right. The parameter DEFault is used as a place holder. Specifying DEF leaves the parameter value unchanged.
2. When the measurement result is linear this parameter represents the number of significant digits. When the measurement result is logarithmic 1 to 4 represents a resolution of 1, 0.1, 0.01 and 0.001 respectively.
3. E4417A only.

Example

```
MEAS1:DIFF:REL? DEF, 3, (@2), (@1)
```

This command queries the upper window's relative difference measurement of channel B - channel A, using the current sensor range and a resolution setting of 3 on both channels.

MEASure[1]|2|3|4[:SCALar][:POWER:AC]:RATio? [<expected_value>,<resolution>,<source list>]]

MEASure[1]|2|3|4[:SCALar][:POWER:AC]:RATio?
[<expected_value>,<resolution>,<source list>]]

This command sets the specified window's measurement function to ratio mode with relative mode off, aborts, configures then initiates both channel A and B, calculates the ratio measurement result and places the result on the bus. The result is a ratio based measurement and is expressed in the units defined by UNIT[1] | 2 | 3 | 4 : POWER : RATio.

Syntax

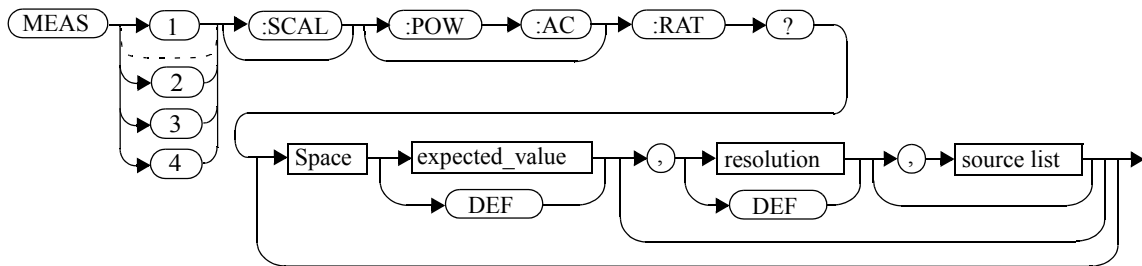

Parameters

Refer to “Optional Parameters”, on page 2-3 for additional details on the parameters in this command.

Item	Description/Default	Range of Values
expected_value (for the expected power level)	The power meter ignores the numeric value entered in this parameter. Any value entered is treated like DEF.	sensor dependent DEF ¹
resolution	A numeric value for the resolution. If unspecified the current resolution setting is used.	1 to 4 ² 1.0, 0.1, 0.01, 0.001 DEF ¹
source list	This channel list specifies the channels used to calculate the ratio. If unspecified and the current window setup is a ratio measurement then this ratio setup is used, otherwise it defaults to channel A/B (E4417A) or A/A (E4416A).	(@1),(@2) ³ (@2),(@1) ³ (@1),(@1) (@2),(@2) ³

MEASure[1]|2|3|4[:SCALar][:POWer:AC]:RATio? [<expected_value>[,<resolution>[,<source list>]]]

1. The mnemonic DEF means DEFault. This is not equivalent to the DEFault parameter used in the command sub-systems. The parameters must be entered in the specified order. If parameters are omitted, they will default from the right. The parameter DEFault is used as a place holder. Specifying DEF leaves the parameter value unchanged.
2. When the measurement result is linear this parameter represents the number of significant digits. When the measurement result is logarithmic 1 to 4 represents a resolution of 1, 0.1, 0.01 and 0.001 respectively.
3. E4417A only.

Example

```
MEAS2:RAT? DEF,1,(@1),(@2)
```

This command queries the lower window's ratio measurement of channel A over channel B, using the current sensor range and a resolution of 1 on both channels.

MEASure[1]|2|3|4[:SCALar][:POWER:AC]:RATio:RELative? [<expected_value>[,<resolution>[,<source list>]]]

MEASure[1]|2|3|4[:SCALar][:POWER:AC]:RATio:RELative? [<expected_value>[,<resolution>[,<source list>]]]

This command sets the specified window’s measurement function to ratio mode with relative mode on, aborts, configures then initiates both channel A and B, calculates the ratio measurement and places the result on the bus. The result is a ratio based measurement and is expressed in the units defined by `UNIT[1]|2|3|4:POWER:RATio`. The relative value used is that set by the `CALCulate:RELative:MAGNitude:AUTO` command.

Syntax

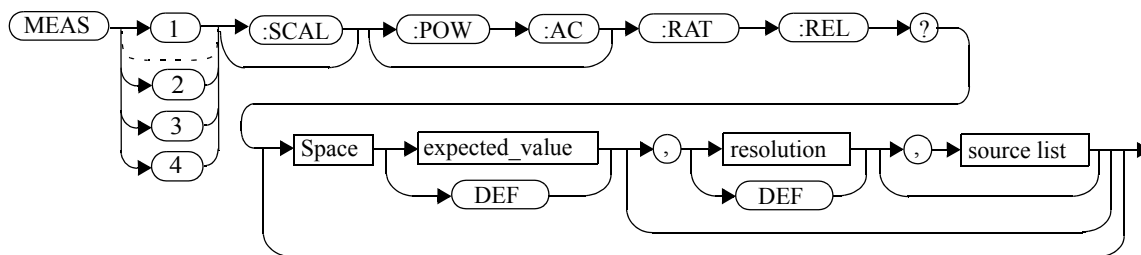

Parameters

Refer to “Optional Parameters”, on page 2-3 for additional details on the parameters in this command.

Item	Description/Default	Range of Values
expected_value (for the expected power level)	The power meter ignores the numeric value entered in this parameter. Any value entered is treated like DEF.	sensor dependent DEF ¹
resolution	A numeric value for the resolution. If unspecified the current resolution setting is used.	1 to 4 ² 1.0, 0.1, 0.01, 0.001 DEF ¹

MEASure[1][2][3][4[:SCALar][:POWer:AC]:RATio:RELative? [<expected_value>[,<resolution>[,<source list>]]]

Item	Description/Default	Range of Values
source list	This channel list specifies the channels used to calculate the ratio. If unspecified and the current window setup is a ratio measurement then this ratio setup is used, otherwise it defaults to channel A-B (E4417A) or A-A (E4416A).	(@1),(@2) ³ (@2),(@1) ³ (@1),(@1) (@2),(@2) ³

1. The mnemonic DEF means DEFault. This is not equivalent to the DEFault parameter used in the command sub-systems. The parameters must be entered in the specified order. If parameters are omitted, they will default from the right. The parameter DEFault is used as a place holder. Specifying DEF leaves the parameter value unchanged.

2. When the measurement result is linear this parameter represents the number of significant digits. When the measurement result is logarithmic 1 to 4 represents a resolution of 1, 0.1, 0.01 and 0.001 respectively.

3. E4417A only.

Example

MEAS : RAT : REL ?

This command queries the relative ratio measurement on the upper window.

Measurement Commands

MEASure[1]|2|3|4[:SCALar][:POWer:AC]:RATio:RELative? [<expected_value>[,<resolution>[,<source list>]]]

THIS PAGE HAS BEEN INTENTIONALLY LEFT BLANK.

3

———— **CALCulate Subsystem**

CALCulate Subsystem

The CALCulate subsystem performs post acquisition data processing. Functions in the SENSE subsystem are related to data acquisition, while the CALCulate subsystem operates on the data acquired by a SENSE function.

There are four independent CALCulate blocks in the power meter: two for each window. The numeric suffix of the CALCulate command determines which CALCulate block will be used and where the measurement result will be displayed:

- CALC1: the measurement result is displayed as the upper window/upper measurement.
- CALC2: the measurement result is displayed as the lower window/upper measurement.
- CALC3: the measurement result is displayed as the upper window/lower measurement.
- CALC4: the measurement result is displayed as the lower window/lower measurement.

Data from both SENSE blocks may feed any or all of the CALCulate blocks via the MATH command. Figure 0-12 details where the commands are applied within the CALCulate block.

Figure 0-12: CALCulate Block

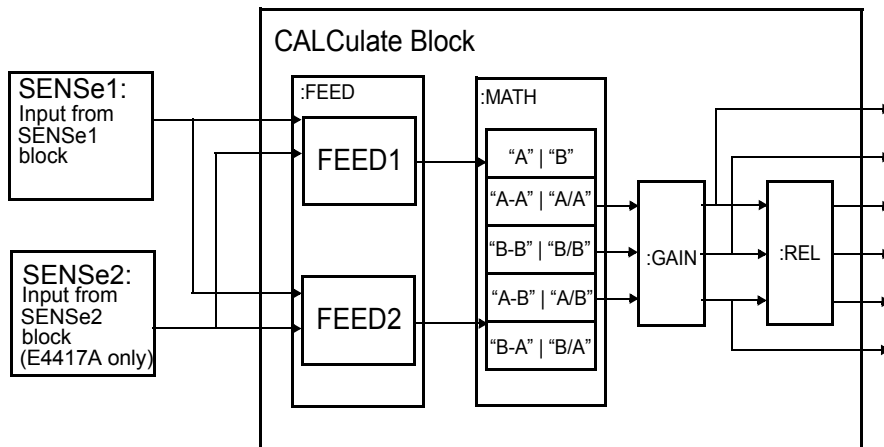

Keyword	Parameter Form	Notes	Page
CALCulate[1] 2 3 4			
:FEED[1] 2	<data_handle>		page 3-4
:GAIN			
[:MAGNitude]	<numeric_value>		page 3-7
:STATe	<boolean>		page 3-9
:LIMit			
:CLEAr			
:AUTO	<boolean>		page 3-12
[:IMMEDIATE]			page 3-14
:FAIL?		[query only]	page 3-15
:FCOunt?		[query only]	page 3-16
:LOWer			
[:DATA]	<numeric_value>		page 3-18
:STATe	<boolean>		page 3-22
:UPPer			
[:DATA]	<numeric_value>		page 3-20
:MATH			
[:EXPRession]	<string>		page 3-25
:CATalog?		[query only]	page 3-27
:PHOLD			
:CLEAr		[no query]	page 3-28
:RELative			
[:MAGNitude]			
:AUTO	<boolean>		page 3-30
:STATe	<boolean>		page 3-32

CALCulate[1]|2|3|4:FEED[1]|2 <string>

This command sets the input measurement mode to be fed to the specified input on the CALC block. It is applied to the measurement after the CALC:MATH:EXPR command has been used to specify which channel the feed will be taken from.

Measurement modes are coupled for combination measurements (for example, ratio measurements). For example, if one feed is changed to PTAV, the other is automatically changed to PTAV.

Under certain circumstances the measurement mode may be changed by the CALC:MATH:EXPR command. Refer to page 3-25 for further information.

Syntax

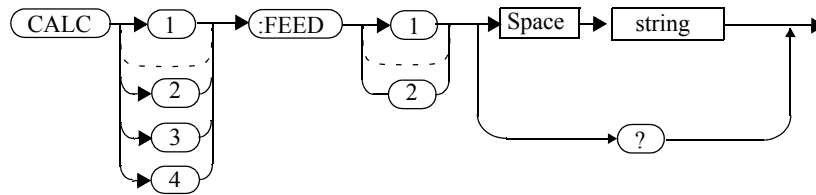

Parameters

Item	Description	Range of Values
string	<p>The input measurement type to be fed to the specific input on the CALC block:</p> <ul style="list-style-type: none"> • PEAK: peak power. • PTAV: peak to average. • AVER: average. <p>Values may be followed by ON SWEEP [1] 2 3 4 where the numeric specifies the gate to be used for the feed. For example: "POW:PEAK ON SWEEP2"</p> <p>If ON SWEEP [1] 2 3 4 is not supplied, the gate used is left unchanged.</p> <p>A feed of "" (empty string) disables the CALC block and switches off that display line.</p>	<p>"POW:PEAK"</p> <p>"POW:PTAV"</p> <p>"POW:AVER"</p>

Example

```
CALC3:FEED2 "POW:AVER ON  
SWEEP2"
```

This command selects the input for FEED2 of CALC block CALC3 to be average power, using gate 2. The channel from which the feed is taken is determined by CALC:MATH:EXPR.

Reset Condition

On reset, data_handle is set to :POW:AVER.

Query

```
CALCulate[1]|2|3|4:FEED[1]|2?
```

The query returns the current value of the string.

Query Example

```
CALC1:FEED2?
```

This command queries the current setting of the data_handle on FEED2 of the upper window/upper measurement.

Error Message

- If the command is used when no sensor is attached, error -241 “Hardware missing” occurs.
- If <string> contains ON SWEEP[1]|2|3|4 and the feed’s TRIG:SOUR is not INT or EXT (for single channel power meters) or INT1, INT2 or EXT (for dual channel power meters), error -221 “Settings conflict” occurs.
- If the command changes the measurement mode to PEAK or PTAV when a non E9320 sensor is connected or an E9320 sensor is connected and set to AVERAge mode rather than NORMa1 mode, error -221, “Settings Conflict” occurs.

CALCulate[1]|2|3|4:GAIN Commands

These commands are used to enter and enable a display offset on the specified window/measurement. The display offset is applied to the measurement signal after any math calculation.

The following commands are detailed in this section:

CALCulate[1]|2|3|4:GAIN[:MAGNitude] <numeric value>

CALCulate[1]|2|3|4:GAIN:STATE <boolean>

CALCulate[1]|2|3|4:GAIN[:MAGNitude] <numeric_value>

This command is used to enter a value for the display offset on the specified window/measurement. The display offset is applied to the measurement signal after any math calculation.

Entering a value using this command automatically turns the CALCulate[1] | 2 | 3 | 4 :GAIN :STATe command to ON.

Syntax

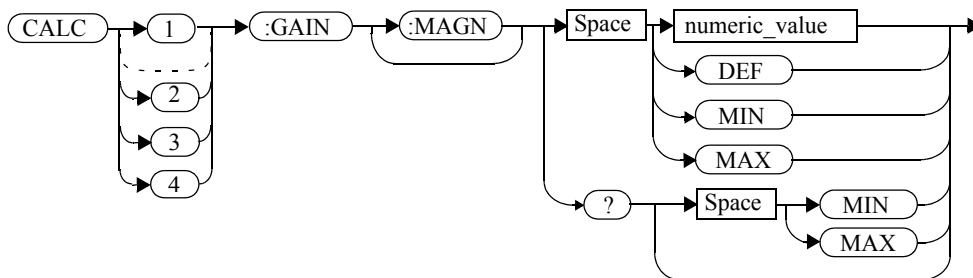

Parameters

Item	Description/Default	Range of Values
numeric_value	A numeric value for the display offset: <ul style="list-style-type: none"> DEF : the default value is 0 dB. MIN : -100.000 dB. MAX : +100.000 dB. 	-100.000 to +100.000 dB DEF MIN MAX

Example

CALC2 :GAIN 20

This command enters a display offset of 20 dB to the window/lower measurement.

Reset Condition

On reset, the display offset is set to 0 dB (DEF).

Query

CALCulate[1]|2|3|4:GAIN[:MAGNitude]? [MIN|MAX]

The query returns the current setting of the display offset or the value associated with MIN and MAX.

Query Example

CALC1:GAIN?

This command queries the current setting of the display offset on the upper window/upper measurement.

Error Message

If CALCulate[1]|2|3|4:GAIN[:MAGNitude] is set to ON while SENSE:SPEEd is set to 200, error -221, “Settings Conflict” occurs.

CALCulate[1]|2|3|4:GAIN:STATe <boolean>

This command is used on the specified window/measurement to enable and disable the display offset set by the CALCulate[1] | 2 | 3 | 4 :GAIN[:MAGNitude] command.

Syntax

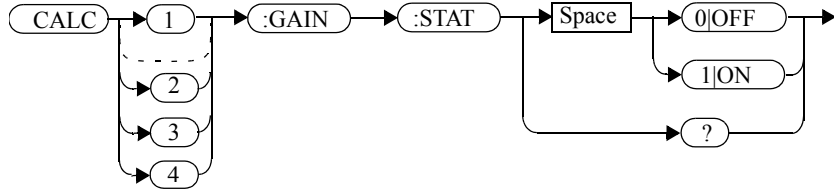

Example

CALC2 :GAIN:STAT 1

This command enables the display offset for the lower window/ upper measurement.

Reset Condition

On reset, the gain is disabled.

Query

CALCulate[1] | 2 | 3 | 4 :GAIN:STATe?

The query enters a 1 or 0 into the output buffer indicating the status of the display offset.

- 1 is returned when the display offset feature is enabled.
- 0 is returned when the display offset feature is disabled.

Query Example

CALC1 :GAIN:STAT?

This command queries whether the display offset in the upper window/upper measurement is on or off.

Error Message

If CALCulate[1] | 2 | 3 | 4 : GAIN : STATe is set to ON while SENSE : SPEEd is set to 200, error -221, “Settings Conflict” occurs.

CALCulate[1]|2|3|4:LIMit Commands

These commands set the limits on both the upper and lower windows/measurements enabling you to:

- Set upper and lower level limits.
- Query if there has been a failure.
- Count the number of failures.
- Clear the counter.

The following commands are detailed in this section:

```
CALCulate[1] | 2 | 3 | 4 : LIMit : CLear : AUTo <boolean>  
CALCulate[1] | 2 | 3 | 4 : LIMit : CLear [IMMediate]  
CALCulate[1] | 2 | 3 | 4 : LIMit : FAIL?  
CALCulate[1] | 2 | 3 | 4 : LIMit : FCOUNT?  
CALCulate[1] | 2 | 3 | 4 : LIMit : LOWer [ : DATA]  
CALCulate[1] | 2 | 3 | 4 : LIMit : UPPer [ : DATA]  
CALCulate[1] | 2 | 3 | 4 : LIMit : STATe <boolean>
```

CALCulate[1]|2|3|4:LIMit:CLEar:AUTO <boolean>|ONCE

This command controls when the FCO (fail counter) is cleared of any limit failures. The FCO is used to determine the results returned by the CALCulate[1] | 2 | 3 | 4:LIMit:FAIL? query.

- If ON is specified, the FCO is set to 0 each time a measurement is:
 - Initiated using INITiate[:IMMEDIATE].
 - Initiated using INITiate:CONTinuous ON.
 - Measured using MEASure?
 - Read using READ?
- If OFF is specified, the FCO is not cleared by the above commands.
- If ONCE is specified, the FCO is cleared only after the first initialization then starts accumulating any limit failures.

Syntax

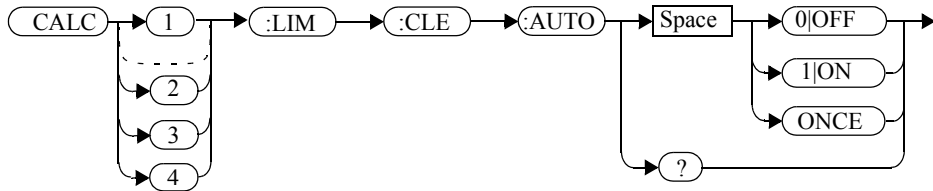

Example

```
CALC1:LIM:CLE:AUTO 1
```

This command switches on automatic clearing of the FCO for the upper window/upper measurement.

Reset Condition

On reset, both windows and their measurements are set to ON.

Query

```
CALCulate[1] | 2 | 3 | 4 : LIMit : CLEar : AUTO ?
```

The query command enters a 1 or 0 into the output buffer indicating whether limit failures are cleared automatically when a new measurement is initiated on the specified window section.

- 1 is entered into the output buffer when limit failures are cleared automatically when a new measurement is initiated.
- 0 is entered into the output buffer when limit failures are not cleared automatically when a new measurement is initiated.

In the case where limit failures are cleared once, when a query occurs a 1 is entered into the output buffer if no measurement is initiated. If a measurement is initiated then 0 is entered.

Query Example

```
CALC1 : LIM : CLE : AUTO ?
```

This command queries when the FCO is cleared for the upper window/upper measurement.

CALCulate[1]|2|3|4:LIMit:CLEar[:IMMEDIATE]

This command immediately clears the FCO (fail counter) of any limit failures for the specified window. The FCO is used to determine the results returned by the CALCulate[1] | 2 | 3 | 4 : LIMit : FAIL? query

Syntax

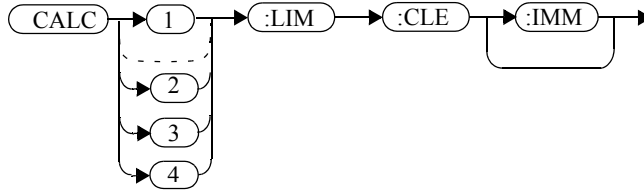

Example

CALC2 : LIM : CLE : IMM

This command clears the FCO for the lower window/upper measurement.

CALCulate[1]|2|3|4LIMit:FAIL?

This query enters a 1 or 0 into the output buffer indicating whether there have been any limit failures for the specified window. A limit failure is defined as CALC [1] | 2 | 3 | 4 :LIMit :FCO? being non-zero. The FCO (fail counter) can be zeroed using the CALC [1] | 2 | 3 | 4 :LIMit :CLEar command.

- 1 is returned when one or more limit failures have occurred.
- 0 is returned when no limit failures have occurred.

Syntax

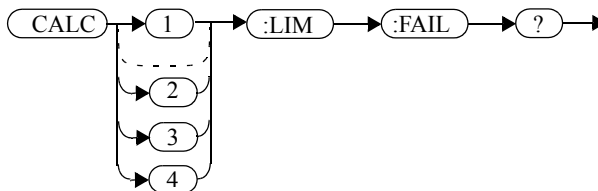

Example

CALC1 :LIM:FAIL?

This command queries if there have been any limit failures on the upper window/upper measurement.

Reset Condition

On reset, the buffer is set to zero for both upper and lower window measurements.

CALCulate[1]|2|3|4:LIMit:FCOunt?

This query returns the total number of limit failures for the specified window/measurement.

If the appropriate STATE commands are set to ON, each time a measurement is initiated on the specified window/measurement and the result is outside the limits, the counter is incremented by one.

If the measured value is equal to a limit, this is a limit pass.

The counter is reset to zero by any of the following commands:

- *RST
- CALCulate[1] | 2 | 3 | 4 : LIMit : CLear : IMMEDIATE
- CALCulate[1] | 2 | 3 | 4 : LIMit : CLear : AUTO ON

When CALCulate[1] | 2 | 3 | 4 : LIMit : CLear : AUTO is set to ON, the counter is set to zero *each* time a measurement is:

- measured using MEASure?
- read using READ?
- initiated using:
 - INITiate[:IMMEDIATE] or,
 - INITiate:CONTinuous ON

When CALCulate[1] | 2 | 3 | 4 : LIMit : CLear : AUTO is set to ONCE, the counter is set to zero the *first* time a measurement is:

- measured using MEASure?
- read using READ?
- initiated using:
 - INITiate[:IMMEDIATE] or,
 - INITiate:CONTinuous ON

The maximum number of errors is $2^{16}-1$. If more than $2^{16}-1$ errors are detected the counter returns to zero.

Syntax

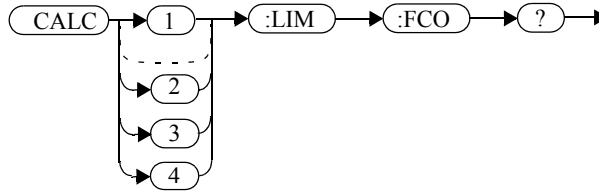

Example

CALC1 :LIM:FCO?

This command queries the number of limit failures on the upper window/upper measurement.

Reset Condition

On reset, the counter is set to zero for both measurements of the upper and lower windows

CALCulate[1]|2|3|4:LIMit:LOWer[:DATA] <numeric_value>

This command enters a value for the lower test limit for the specified window/measurement used in the CALCulate[1] | 2 | 3 | 4 :LIMit :FAIL? test. The units used are dependent on the current setting of UNIT:POWER and CALCulate:RELative:STATe as shown in Table 0-5. When the measured value is less than the value specified in CALCulate[1] | 2 | 3 | 4 :LIMit:LOWer[:DATA], CALCulate[1] | 2 | 3 | 4 :LIMit:FAIL? reports a fail. When the measured value is greater than or equal to the limit, a fail is not reported.

Table 0-5: Measurement Units

Measurement Mode	Measurement Type	CALC:REL:STAT OFF		CALC:REL:STAT ON	
		Linear	Log	Linear	Log
Single Channel	Avg, Pk	Watt	dBm	%	dB
	Pk-Avg	%	dB	%	dB
Ratio	Avg, Pk, Pk-Avg	%	dB	%	dB
Difference	Avg, Pk	Watt	dBm	%	dB
	Pk-Avg	%	dB	%	dB

Syntax

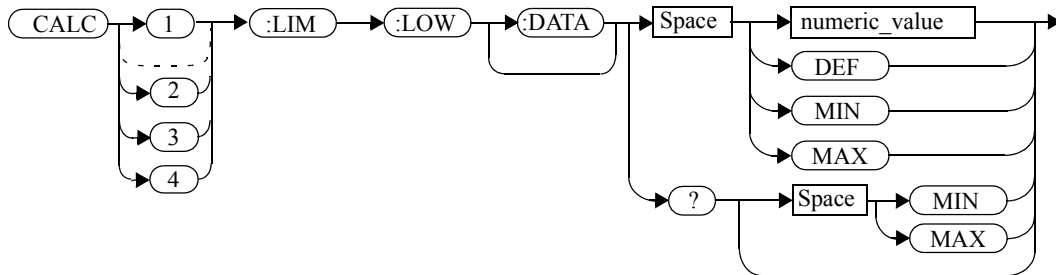

Parameters

Item	Description/Default	Range of Values
numeric_value	A numeric value for the lower test limit: <ul style="list-style-type: none"> • DEF: the default is -90.00 dBm or -90 db. • MIN: -150 dBm or -180 dB. • MAX: +230 dBm or +200 dB. 	-150 to +230 dBm or -180 to +200 dB DEF MIN MAX

Example

CALC2:LIM:LOW:DATA 0.1

This command enters a lower limit for the lower window/upper measurement depending on the window's units as follows:

dBm = 0.1 dBm

W = 100 mW

dB = 0.1 dB

% = 0.1 %

Reset Condition

On reset, both measurements of the upper and lower windows are set to -90.00 dBm or -90 dB (DEF).

Query

CALCulate[1]|2|3|4:LIMit:LOWer[:DATA]? [MIN|MAX]

The query returns the current setting of the lower limit or the values associated with MIN and MAX for the specified window.

Query Example

CALC2:LIM:LOW:DATA?

This command queries the lower limit set for the lower window upper measurement.

CALCulate[1]|2|3|4:LIMit:UPPer[:DATA] <numeric_value>

This command enters a value for the upper test limit for the specified window/measurement used in the CALCulate[1] | 2 | 3 | 4 :LIMit :FAIL? test. The units used are dependent on the current setting of UNIT:POWer and CALCulate:RELative:STATe as shown in Table 0-6. When the measured power is greater than the value specified in CALCulate[1] | 2 | 3 | 4 :LIMit:UPPer[:DATA], CALCulate[1] | 2 | 3 | 4 :LIMit:FAIL? reports a fail. When the measured level is less than or equal to the limit, a fail is not reported.

Table 0-6: Measurement Units

Measurement Mode	Measurement Type	CALC:REL:STAT OFF		CALC:REL:STAT ON	
		Linear	Log	Linear	Log
Single Channel	Avg, Pk	Watt	dBm	%	dB
	Pk-Avg	%	dB	%	dB
Ratio	Avg, Pk, Pk-Avg	%	dB	%	dB
Difference	Avg, Pk	Watt	dBm	%	dB
	Pk-Avg	%	dB	%	dB

Syntax

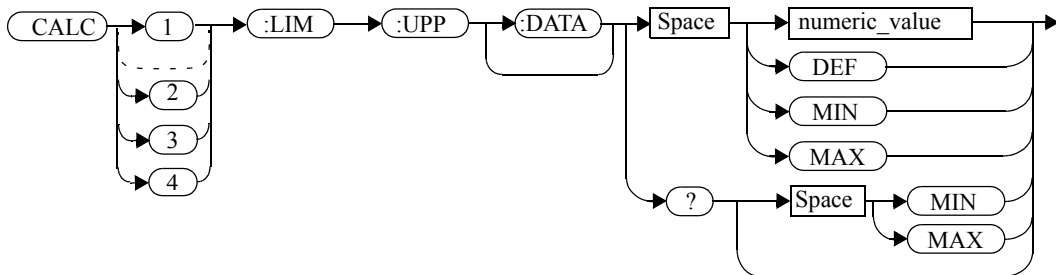

Parameters

Item	Description/Default	Range of Values
numeric_value	<p>A numeric value for the upper test limit:</p> <ul style="list-style-type: none"> • DEF : the default is +90.00 dBm or +90 dB. • MIN : -150 dBm or -180 db. • MAX : +230 dBm or +200 dB. 	<p>-150 to +230 dBm or -180 to +200 dB</p> <p>DEF MIN MAX</p>

Example

CALC2:LIM:UPP:DATA 5

This command enters an upper limit for the lower window/upper measurement depending on the window's units as follows:

dBm = 5 dBm

W = 5 W

dB = 5 dB

% = 5%

Reset Condition

On reset, both channels are set to +90.00 dBm or +90 dB.

Query

CALCulate[1]|2|3|4:LIMit:UPPer[:DATA]? [MIN|MAX]

The query returns the current setting of the upper limit or the values associated with MIN and MAX for the specified window/measurement.

Query Example

CALC2:LIM:UPP:DATA?

This command queries the setting of the upper limit for the lower window/upper measurement.

CALCulate[1]|2|3|4:LIMit:STATe <boolean>

This command enables/disables the test limits for the specified window.

Syntax

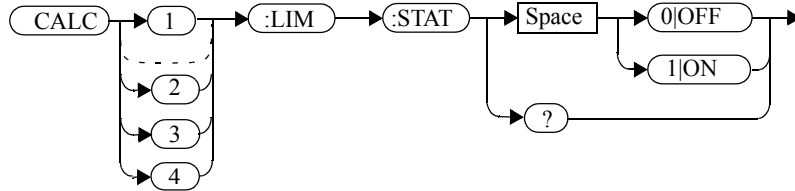

Example

```
CALC2 : LIM : STAT 1
```

This command enables the limit checking function for the lower window upper measurement.

Reset Condition

On reset, limit checking is disabled.

Query

```
CALCulate[1] | 2 | 3 | 4 : LIMit : STATe?
```

The query enters 1 or 0 into the output buffer indicating the status of the limits testing feature for the specified window/measurement.

- 1 is returned when limits testing is enabled.
- 0 is returned when limits testing is disabled.

Query Example

```
CALC1 : LIM : STAT?
```

This command queries whether the limit checking function for the upper window/upper measurement is on or off.

Error Message

If CALCulate[1|2|3|4]:LIMit:STATe is set to ON while [SENSE[1]]|SENSE2:SPEEd is set to 200, error -221, “Settings Conflict” occurs.

CALCulate[1]|2|3|4:MATH Commands

These commands define and carry out the following mathematical transformations on SENSE data:

- Single channel.
- Difference.
- Ratio.

The following commands are detailed in this section:

```
CALCulate[1] | 2 | 3 | 4 : MATH [ : EXPRESSION ] <string>  
CALCulate[1] | 2 | 3 | 4 : MATH [ : EXPRESSION ] : CATalog?
```

CALCulate[1]|2|3|4:MATH[:EXPR] <string>

This command sets the specified window/measurement to a single channel, difference or ratio measurement.

The command may result in a change to the measurement mode set by CALC:FEED <string>. The following sequence of commands provides an example:

1. SENS2:DET:FUN=AVERage
2. CALC:MATH "(SENS1)"
3. CALC:FEED1 "POW:PEAK"
4. CALC:MATH "(SENS2)"

The FEED1 measurement mode, set in step 3, is made invalid by step 4 and automatically changed to "POW:AVER".

Syntax

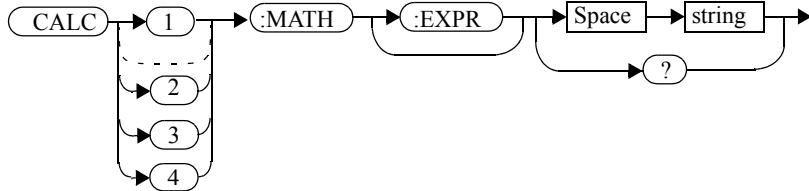

Parameters

Item	Description/Default	Range of Values
string	<p>A single string value detailing the measurement type:</p> <ul style="list-style-type: none"> • For the Agilent E4416A the default is SENS1. • For the Agilent E4417A the default is SENS1 if the upper window is selected, or SENS2 if the lower window is selected. 	<p>"(SENS1)"¹ "(SENS2)"^{1,2} "(SENS1-SENS1)"¹ "(SENS2-SENS2)"^{1,2} "(SENS1/SENS1)"¹ "(SENS2/SENS2)"^{1,2} "(SENS1-SENS2)"^{1,2} "(SENS2-SENS1)"^{1,2} "(SENS1/SENS2)"^{1,2} "(SENS2/SENS1)"^{1,2}</p>

1. Quotes are mandatory. Either single or double quotes may be used.
2. E4417A only.

Example

CALC2:MATH "(SENS2/SENS1)" *This command sets the lower window/upper measurement to make a channel B/A ratio measurement.*

Reset Condition

On reset, the Agilent E4416A upper and lower window measurements are set to channel A (" (SENS1) "). On the E4417A the upper window measurements are set to channel A (" (SENS1) ") and the lower window measurements to channel B (" (SENS2) ")

Query

CALCulate[1] | 2 | 3 | 4 : MATH [: EXPRession] ?

The query returns the current math measurement setting on the specified window.

Query Example

CALC1:MATH? *This command queries the current setting of the math expression on the upper window/upper measurement.*

Error Messages

- For the single channel E4416A power meter: if <string> is not set to "(SENS1)" while SENSE:SPEED is set to 200, error -221, "Settings Conflict" occurs.
- For the dual channel E4417A power meter: if <string> is not set to "(SENS1)" or "(SENS2)" while SENS1:SPEED or SENS2:SPEED is set to 200, error -221, "Settings Conflict" occurs.

CALCulate[1]|2|3|4:MATH[:EXPRession]:CATalog?

This query lists all the defined expressions. The response is a list of comma separated strings. Each string contains an expression.

- For the E4416A the string is:
`" (SENS1) ", " (SENS1-SENS1) ", " (SENS1/SENS1) "`
- For the E4417A the string is:
`" (SENS1) ", " (SENS2) ", " (SENS1/SENS2) ",
" (SENS2/SENS1) ", " (SENS1-SENS2) ", " (SENS2-SENS1) "
" (SENS1-SENS1) ", " (SENS2-SENS2) ", " (SENS1/SENS1) ",
" (SENS2/SENS2) "`

Syntax

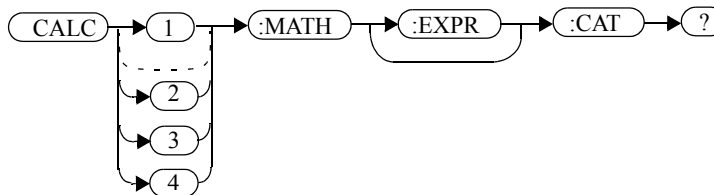

Example

CALC1 :MATH :CAT?

This command lists all the defined math expressions.

CALCulate[1]|2|3|4:PHOLd:CLEAr

This command clears the peak hold value for a specified CALC block so that a new peak hold value can be set.

Note

Clearing the peak hold value for a specified CALC block may affect the peak hold value of other CALC blocks, depending on the CALC channel set up (set by CALC : MATH : EXPR).

Syntax

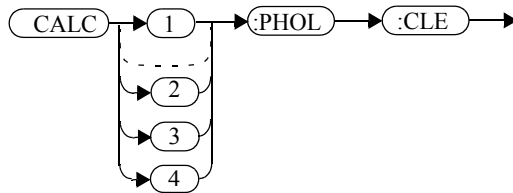

Example

CALC2 : PHOLd : CLEAr

This command clears the peak hold value for CALC2.

Error Messages

- If no power sensor is connected, error -241 “Hardware missing” occurs.
- If a non E9320 Series power sensor is connected, error -241 “Hardware missing” occurs.
- If SENS : DET : FUNC is set to AVER or TRIG : SOUR is set to INT1, INT2 or EXT, error -221 “Settings conflict” occurs.

CALCulate[1]|2|3|4:RELative Commands

These commands compare the measurement signal to a reference value.

Within the CALCulate block the relative value is applied to the measurement signal after any math calculations and display offsets have been applied.

The commands described in this section:

```
CALCulate[1] | 2 | 3 | 4 :RELative[:MAGNitude]:AUTO  
    <boolean> | ONCE  
CALCulate[1] | 2 | 3 | 4 :RELative:STATE <boolean>
```

CALCulate[1]|2|3|4:RELative[:MAGNitude]:AUTO <boolean>|ONCE

This command sets the reference value to be used in the relative measurement. Within the CALCulate block the relative value is applied to the measurement signal after any math calculations and display offsets have been applied.

The value should be set to ONCE to set the reference value to be used in relative measurements. Selecting ONCE sets the reference value to that of the measurement signal after any math calculations and display offsets have been applied. After the reference value has been set the command returns to OFF. Setting this command to ONCE turns the CALCulate[1]|2|3|4:RELative:STATE command to ON.

If 0|OFF is selected, no reference value is applied to the measurement signal. There is no situation in which you would want to send this command with OFF. OFF is only available because it is required for the query response.

If 1|ON is selected, it causes error -224, “Illegal parameter value” to occur.

Syntax

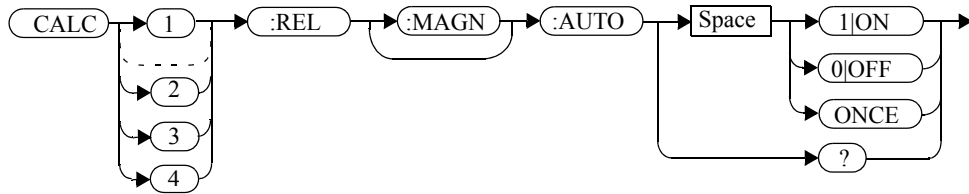

Example

```
CALC1:REL:AUTO ONCE
```

This command sets a reference value to be used in the relative measurement on the upper window/upper measurement.

Query

CALCulate[1] | 2 | 3 | 4 :RELative[:MAGNitude]:AUTO?

The query always returns OFF.

Error Message

- If CALCulate:RELative[:MAGNitude]:AUTO is set to ONCE while SENSE:SPEEd is set to 200, error -221, “Settings Conflict” occurs.
- If the value is set to ON error -224, “Illegal parameter value” occurs.

CALCulate[1]|2|3|4:RELative:STATe <boolean>

This command enables/disables relative mode. If the command is:

- disabled, the measurement signal remains unchanged.
- enabled, the current relative value set by CALCulate:RELative:MAGnitude:AUTO is applied to the measurement signal.

Syntax

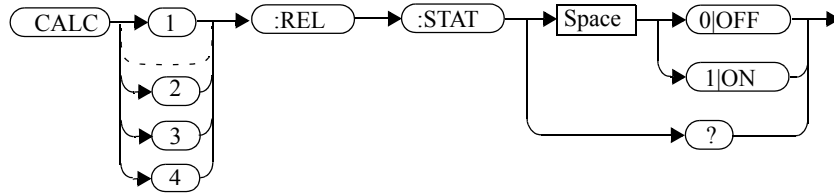

Example

```
CALC1:REL:STAT OFF
```

This command disables the relative mode on the upper window/upper measurement.

Reset Condition

On reset, relative mode is disabled.

Query

```
CALCulate[1]|2|3|4:RELative:STATe?
```

The query returns a 1 or 0 into the output buffer.

- 1 is returned when relative mode is enabled.
- 0 is returned when relative mode is disabled.

Query Example

```
CALC1:REL:STAT?
```

This command queries whether relative mode is off or on for the upper window/upper measurement.

Error Message

If CALCulate:RELative:STATe is set to ON while SENSE:SPeEd is set to 200, error -221, “Settings Conflict” occurs.

4

———— **CALibration Subsystem**

CALibration Subsystem

The CALibration command subsystem is used to zero and calibrate the power meter. It is also used to set the reference calibration factor for the power sensor which is being used.

The numeric suffix of the CALibration command refers to a specific channel:

- CALibration1 represents channel A.
- CALibration2 represent channel B.
 This command does not apply to the single channel E4416A power meter and results in the error “Header suffix out of range.”

Zeroing and calibration of the power meter is recommended:

- When a 5°C change in temperature occurs.
- When you change the power sensor.
- Every 24 hours.
- Prior to measuring low level signals. For example, 10 dB above the lowest specified power for your sensor.

The following CALibration commands are overlapped commands:

- CAL:ALL
- CAL:AUTO
- CAL:ZERO:AUTO

An overlapped command allows the instrument to continue parsing and executing subsequent commands while it is still executing.

Keyword	Parameter Form	Notes	Page
CALibration[1] 2			
[:ALL]		[event; no query]	page 4-3
[:ALL]?		[event;query]	page 4-5
:AUTO	<boolean> ONCE		page 4-7
:ECONtrol			
:STATe	<boolean>		page 4-9
:RCALibration	<boolean>		page 4-10
:RCFActor	<numeric_value>	[non-SCPI]	page 4-12
:ZERO			
:AUTO	<boolean> ONCE		page 4-14
:NORMAl			
:AUTO	<boolean> ONCE		page 4-15

CALibration[1]|2[:ALL]

Note This command is identical to `CALibration[1]|2[:ALL]?`, however, unlike the query it does not provide a response to indicate whether the calibration has been successful or not.

This command causes the power meter to perform a calibration sequence on the specified channel. The command assumes that the power sensor is connected to the POWER REF output. The calibration sequence consists of:

- Zeroing the power meter (`CALibration:ZERO:AUTO ONCE`), and
- calibrating the power meter (`CALibration:AUTO ONCE`).

For 8480 Series power sensors and N8480 Series power sensors with Option CFT, the reference calibration factor used during this calibration can be derived from either an active sensor calibration table or the value entered using `CALibration:RCFactor`. The actual value used is the one which was most recently set. That is, a value entered using `CALibration:RCFactor` is overridden if a sensor calibration table is subsequently selected and enabled. Conversely, `CALibration:RCFactor` overrides any reference calibration factor previously set from a sensor calibration table. To determine the currently set reference calibration factor use `CALibration:RCFactor?`

E-Series power sensors and N8480 Series power sensors (excluding Option CFT) have their sensor calibration tables stored in EEPROM which means that the reference calibration factor is automatically downloaded by the power meter.

Syntax

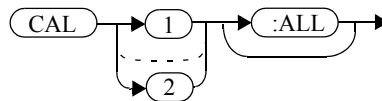

Example

`CAL1 : ALL`

This command causes the power meter to perform a calibration sequence on channel A.

Error Messages

- If the calibration was not carried out successfully the error -231, “Data Questionable; CAL ERROR” occurs. If you are using the E4417A the error message specifies which channel the calibration failed on.
- If zeroing was not carried out successfully the error -231, “Data Questionable; ZERO ERROR” occurs. If you are using the E4417A the error message specifies which channel the calibration failed on.
- If there is no sensor connected, the error -241, “Hardware Missing” occurs.

CALibration[1]|2[:ALL]?

Note This query is identical to `CALibration[1]|2[:ALL]`, however, unlike the command, it provides a response to indicate whether the calibration has been successful or not.

This query causes the power meter to perform a calibration sequence on the specified channel. The query assumes that the power sensor is connected to the POWER REF output. The calibration sequence consists of:

- Zeroing the power meter (`CALibration:ZERO:AUTO ONCE`), and
- calibrating the power meter (`CALibration:AUTO ONCE`).

When the calibration sequence is completed, 0 or 1 is entered into the output buffer to indicate if the sequence was successful. If the result is:

- 0, the calibration has passed.
- 1, the calibration has failed.

For the 8480 Series power sensors and N8480 Series power sensors with Option CFT, the reference calibration factor used during this calibration can be derived from either an active sensor calibration table or the value entered using `CALibration:RCFactor`. The actual value used is the one which was most recently set. That is, a value entered using `CALibration:RCFactor` is overridden if a sensor calibration table is subsequently selected and enabled. Conversely, `CALibration:RCFactor` overrides any reference calibration factor previously set from a sensor calibration table. To determine the currently set reference calibration factor use `CALibration:RCFactor?`

The E-Series power sensors and N8480 Series power sensors (excluding Option CFT) have their sensor calibration tables stored in EEPROM which means that the reference calibration factor is automatically downloaded by the power meter.

Syntax

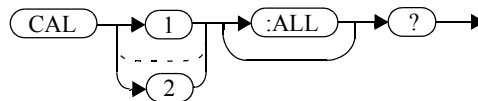

Query Example

CAL1 : ALL?

This command causes the power meter to perform a calibration sequence on channel A and return a result.

Error Messages

- If the calibration was not carried out successfully the error -231, “Data Questionable; CAL ERROR” occurs. If you are using the E4417A the error message specifies which channel the calibration failed on.
- If zeroing was not carried out successfully the error -231, “Data Questionable; ZERO ERROR” occurs. If you are using the E4417A the error message specifies which channel the calibration failed on.
- If there is no sensor connected, the error -241, “Hardware Missing” occurs.

CALibration[1]|2:AUTO <boolean>

This command calibrates the specified channel when ONCE is selected. The command assumes that the power sensor is connected to a 1 mW reference signal. The 0 | OFF parameter is only required for the query response and is ignored in the command. If 1 | ON is selected, the error -224, “Illegal parameter value” occurs.

For 8480 Series power sensors and N8480 Series power sensors with Option CFT, the reference calibration factor used during this calibration can be obtained from an active sensor calibration table or the value entered using CALibration:RCFactor. The actual value used is the one which was most recently set. For example, a value entered using CALibration:RCFactor is overridden if a sensor calibration table is subsequently selected and enabled and CALibration:RCFactor overrides any reference calibration factor previously set from a sensor calibration table. To determine the current reference calibration factor, use CALibration:RCFactor?

The E-Series power sensors and N8480 Series power sensors (excluding Option CFT) have their sensor calibration tables stored in EEPROM which means that the reference calibration factor is automatically downloaded by the power meter.

Note The power meter should be zeroed before calibration using the CALibration:ZERO:AUTO ONCE command.

Syntax

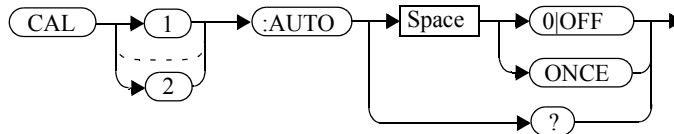

Example

CAL1:AUTO ONCE

This command causes the power meter to perform a calibration on channel A.

Reset Condition

On reset, automatic calibration is disabled.

Query

CALibration[1]|2:AUTO?

The query always returns a value of 0.

Error Messages

- If the calibration was not carried out successfully the error -231, “Data Questionable; CAL ERROR” occurs. If you are using the E4417A the error message specifies which channel the calibration failed on.
- If the command is set to ON the error -224, “Illegal parameter value” occurs.
- If there is no sensor connected, the error -241, “Hardware Missing” occurs.

CALibration[1]|2:ECONtrol:STATe <boolean>

This command enables and disables the rear panel TTL zero/cal inputs. The TTL inputs provide an external means to initiate ZERO and CAL cycles.

Syntax

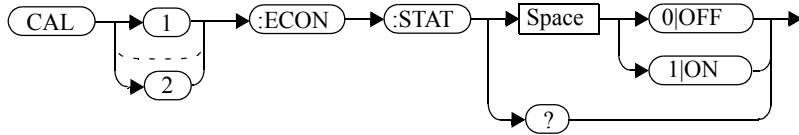

Example

CAL1 : ECON : STAT 1

This command enables the rear panel TTL inputs. Note that enabling the TTL inputs is not channel dependent and CAL1 and CAL2 have the same effect.

Reset Condition

On reset, the TTL zero/cal inputs are disabled.

Query

CALibration[1] | 2 : ECONtrol : STATe ?

The query enters a 1 or 0 into the output buffer indicating whether the TTL inputs are enabled or disabled.

- 1 is returned if the TTL inputs are enabled.
- 0 is returned if the TTL inputs are disabled.

Query Example

CAL1 : ECON : STAT ?

This command queries whether or not the TTL inputs are enabled

CALibration[1]|2:RCALibration <boolean>

This command enables and disables the zero/cal lockout facility. With the lockout facility enabled the power meter is prevented from making measurements until the sensor connected has been zeroed and calibrated.

Syntax

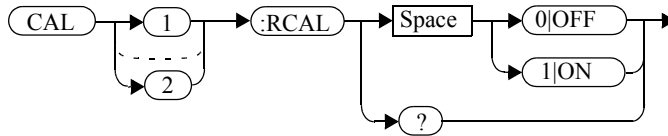

Example

```
CAL1:RCAL 1
```

This command enables the zero/cal lockout facility on channel A.

Reset Condition

On reset, the state of the zero/cal lockout is unaffected.

Query

```
CALibration[1] | 2:RCALibration?
```

The query enters a 1 or 0 into the output buffer indicating whether zero/cal lockout is enabled or disabled.

- 1 is returned if zero/cal lockout is enabled.
- 0 is returned if zero/cal lockout is disabled.

Query Example

```
CAL1:RCAL?
```

This command queries whether or not the zero/cal lockout facility is enabled for channel A.

Error Messages

When `CAL[1]|2:RCAL` is ON and the sensor currently connected to the appropriate channel (A or B) has not been zeroed and calibrated, then any SCPI command which would normally return a measurement result (for example, `FETC?`, `READ?`, `MEAS?` etc) will not return a result but will generate the error -230, "Data corrupt or stale; Please zero and Cal."

Once the sensor has been zeroed and calibrated the commands which return measurement results will function normally.

CALibration[1]|2:RCFactor <numeric_value>

This command is used with 8480 Series power sensors and N8480 Series power sensors with Option CFT to set the reference calibration factor of the specified channel. Reference calibration factors can also be set using sensor calibration tables. The power meter uses the most recently set reference calibration factor.

Syntax

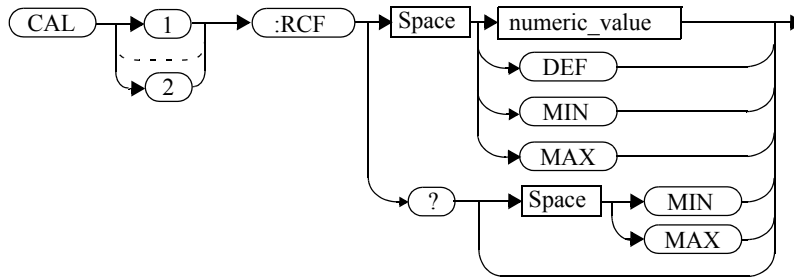

Parameters

Item	Description/Default	Range of Values
numeric_value	A numeric value: <ul style="list-style-type: none"> • DEF : the default is 100%. • MIN: 1%. • MAX : 150%. 	1.0 to 150.0 PCT DEF MIN MAX

Example

CAL1:RCF 98

This command enters a reference calibration factor of 98% to channel A.

Reset Condition

On reset, the reference calibration factor is set to 100%.

Query

```
CALibration[1]|2:RCFactor? [MIN|MAX]
```

The query returns the current setting of the reference calibration factor or the values associated with MIN and MAX.

Query Example

```
CAL2:RCF?
```

This command queries the reference calibration factor of channel B.

Error Messages

If this command is used when an E-Series power sensors or N8480 Series power sensor (excluding Option CFT) is connected the error -241, “Hardware missing” occurs.

CALibration[1]|2:ZERO:AUTO <boolean>

This command causes the power meter to perform its zeroing routine on the specified channel when ONCE is selected. This adjusts the power meter for a zero power reading with no power supplied to the power sensor.

The 0 | OFF parameter is only required for the query response and is ignored in the command. If 1 | ON is selected, it causes the error -224, “Illegal parameter value” to occur.

The command assumes that the power sensor is not connected to a power source.

Syntax

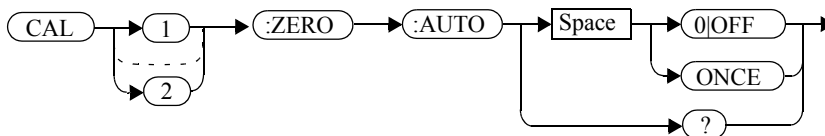

Example

CAL2 : ZERO : AUTO ONCE

This command causes the power meter to perform a zeroing routine on channel B.

Reset Condition

On reset, automatic zeroing is disabled.

Query

CALibration[1] | 2 : ZERO : AUTO ?

The query always returns a value of 0.

Error Messages

- If zeroing was not carried out successfully the error -231, “Data Questionable; ZERO ERROR” occurs. If you are using a dual channel power meter, the error message specifies which channel the zeroing failed on.
- If this command is set to ON the error -224, “Illegal parameter value” occurs.
- If there is no sensor connected, the error -241, “Hardware Missing” occurs.

CALibration[1]|2:ZERO:NORMAL:AUTO <boolean>

This command provides a quick way of zeroing the NORMAL path of an E9320 Series sensor. The average only path is unaffected. The command cannot be used to zero a non-E9320 Series sensor.

The command causes the power meter to perform its zeroing routine on the specified channel when ONCE is selected. This adjusts the power meter for a zero power reading with no power supplied to the power sensor.

The 0 | OFF parameter is only required for the query response and is ignored in the command. If 1 | ON is selected, it causes the error -224, “Illegal parameter value” to occur.

The command assumes that the power sensor is not connected to a power source.

Syntax

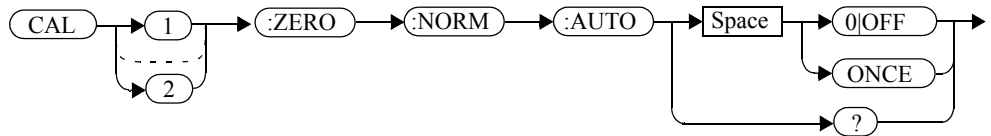

Example

CAL2 : ZERO : NORM : AUTO ONCE

This command causes the power meter to perform a zeroing routine on channel B.

Reset Condition

On reset, automatic zeroing is disabled.

Query

CALibration[1] | 2 : ZERO : NORMAl : AUTO ?

The query always returns a value of 0.

Error Messages

- If zeroing was not carried out successfully the error -231, “Data Questionable; ZERO ERROR” occurs. If you are using a dual channel power meter, the error message specifies which channel the zeroing failed on.
- If this command is set to ON the error -224, “Illegal parameter value” occurs.
- If there is no sensor connected or if a non-E9320 sensor is connected, the error -241, “Hardware missing” occurs.
- If an E9320 sensor is connected and is not in NORMAL mode, the error -221 “Settings conflict” occurs.

5

———— **DISPlay Subsystem**

DISPlay Subsystem

The DISPlay subsystem is used to control the selection and presentation of the windows used on the power meter's display.

Keyword	Parameter Form	Notes	Page
DISPlay			
:CONTrast	<numeric_value>		page 5-3
:ENABle	<boolean>		page 5-5
:SCReen			
:FORMat	<character_data>		page 5-6
[:WINDow[1] 2]			
:ANALog			
:LOWer	<numeric_value>		page 5-10
:UPPer	<numeric_value>		page 5-12
:FORMat	<character_data>	[non-SCPI]	page 5-14
:METer			
:LOWer	<numeric_value>	[non-SCPI]	page 5-17
:UPPer	<numeric_value>	[non-SCPI]	page 5-19
[:NUMeric[1] 2]			
:RESolution	<numeric_value>		page 5-21
:SELeCt[1] 2			page 5-23
[:STATe]	<boolean>		page 5-24
:TRACe			
:FEED	<character_data>		page 5-26
:LOWer	<numeric_value>		page 5-28
:UPPer	<numeric_value>		page 5-30

DISPlay:CONTRast <numeric_value>

This command controls the display contrast:

- A contrast of 0 represents a minimum contrast.
- A contrast of 1 represents a maximum contrast.

When the supply power is cycled off then on the contrast sets to the factory default for that particular power meter.

Syntax

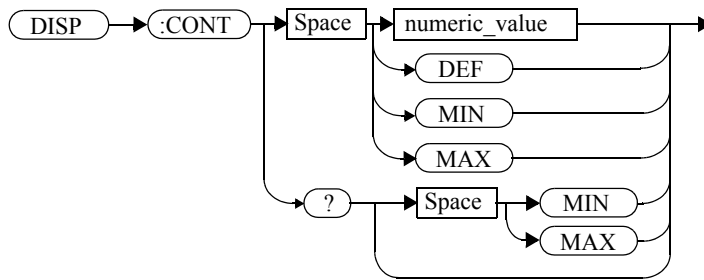

Parameters

Item	Description/Default	Range of Values
numeric_value	<p>A numeric value for the contrast level.</p> <ul style="list-style-type: none"> • DEF: the factory default value which can vary between power meters. • MIN: 0. • MAX: 1. <p>Units are resolved to 0.01.</p>	<p>0 to 1</p> <p>DEF MIN MAX</p>

Example

DISP:CONT 0.75

This command sets the display contrast to 0.75.

Reset Condition

On reset, the contrast is not affected.

Query

DISPlay:CONTRast? [MIN|MAX]

The query returns the current setting of the contrast or the values associated with MIN and MAX. The response format is <NR3>.

Query Example

DISP:CONT?

This command queries the current contrast setting.

DISPlay:ENABle <boolean>

This command is used to enable and disable the display. At power-up the display is always enabled.

Syntax

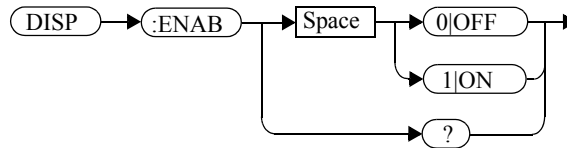

Example

```
DISP:ENAB 0
```

This command disables the display.

Reset Condition

On reset, the display is enabled.

Query

```
DISPlay:ENABle?
```

The query returns a 1 or 0 into the output buffer.

- 1 is returned when the display is enabled.
- 0 is returned when the display is disabled.

Query Example

```
DISP:ENAB?
```

This command queries whether the display is on or off.

DISPlay:SCReen:FORMat <character_data>

This command sets the display format.

Syntax

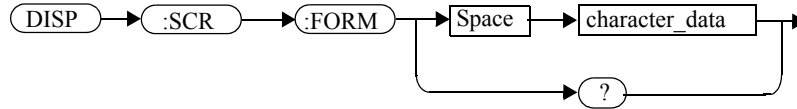

Parameters

Item	Description/Default	Range of Values
character_data	Sets the display format: <ul style="list-style-type: none"> • WINDowed: the windowed format provides two display windows. Each window can display two measurements. • EXPanded: the expanded format provides one display window which can display a single measurement. The EXP display format provides access to softkeys. • FSCReen: the full screen format provides one display window which can display a single measurement. The FSCR display format does not provide access to softkeys. 	WIND EXP FSCR

Example

DISP:SCReen:FORM FSCR

This command sets the display format to full screen.

Reset Condition

On reset, the display format is WIND.

Query

DISPlay:SCReen:FORMat?

The query returns WIND, EXP or FSCR.

Query Example

DISP:SCR:FORM?

This command queries the display format.

DISPlay[:WINDow[1]|2] Commands

These commands control various characteristics of the display windows. WINDow1 and WINDow2 represent the upper and lower windows respectively.

The following commands are detailed in this section:

```
DISPlay[:WINDow[1]|2]:ANALog:LOWer <numeric_value>
DISPlay[:WINDow[1]|2]:ANALog:UPPer <numeric_value>
DISPlay[:WINDow[1]|2]:FORMat <character_data>
DISPlay[:WINDow[1]|2]:METer:LOWer <numeric_value>
DISPlay[:WINDow[1]|2]:METer:UPPer <numeric_value>
DISPlay[:WINDow[1]|2][NUMeric[1|2]]:RESolution
    <numeric_value>
DISPlay[:WINDow[1]|2]:SElect[1]|2
DISPlay[:WINDow[1]|2][:STATE] <boolean>
DISPlay[:WINDow[1]|2]:TRACe:FEED <character_data>
DISPlay[:WINDow[1]|2]:TRACe:LOWer <numeric_value>
DISPlay[:WINDow[1]|2]:TRACe:UPPer <numeric_value>
```

DISPlay[:WINDow[1]|2]:ANALog Commands

These commands control the upper and lower scale limits of the analog meter.

The following commands are detailed in this section:

```
DISPlay[:WINDow[1]|2]:ANALog:LOWer <numeric_value>  
DISPlay[:WINDow[1]|2]:ANALog:UPPer <numeric_value>
```

DISPlay[:WINDow[1]|2]:ANALog:LOWer <numeric_value>

This command sets the analog meter lower scale limit.

Note This command has the same purpose as
DISPlay[:WINDow[1]|2]:METer:LOWer <numeric_value>

The units used are dependent on the current setting of UNIT:POWER and CALCulate:RELative:STATE as shown in the following table:

Table 0-7: Measurement Units

Measurement Mode	Measurement Type	CALC:REL:STAT OFF		CALC:REL:STAT ON	
		Linear	Log	Linear	Log
Single Channel	Avg, Pk	Watt	dBm	%	dB
	Pk-Avg	%	dB	%	dB
Ratio	Avg, Pk, Pk-Avg	%	dB	%	dB
Difference	Avg, Pk	Watt	dBm	%	dB
	Pk-Avg	%	dB	%	dB

Syntax

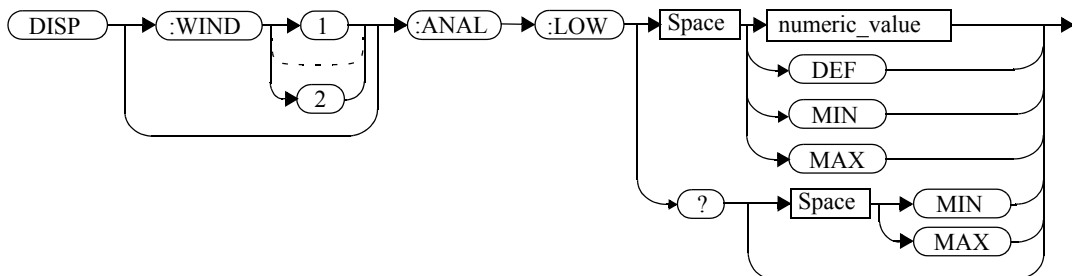

Parameters

Item	Description/Default	Range of Values
numeric_value	<p>A numeric value for the analog meter lower scale limit:</p> <ul style="list-style-type: none"> • DEF: the default is -70 dBm • MIN: -150 dBm • MAX: 230 dBm <p>Units used are determined by the current setting of UNIT:POWer and CALCulate:RELative:STATe as shown in the previous table.</p>	<p>-150 to 230 dBm</p> <p>DEF MIN MAX</p>

Example

DISP:WIND1:ANAL:LOW -50 *This command sets the upper window's analog meter lower scale limit to -50 dBm*

Reset Condition

On reset, the value is set to -70 dBm for both windows.

Query

DISPlay:[WINDow[1]|2]:ANALog:LOW? [MIN|MAX]

The query returns the current setting of the analog meter's lower scale limit, or the value associated with MIN or MAX. The format of the response is <NR3>. The units in which the results are returned are determined by the current setting of UNIT:POWer and CALCulate:RELative:STATe as shown in Table 0-7.

Query Example

DISP:WIND1:ANAL:LOW? *This command queries the lower scale limit set on the analog meter in the upper window.*

DISPlay[:WINDow[1]|2]:ANALog:UPPer <numeric_value>

This command sets the analog meter upper scale limit.

Note This command has the same purpose as
 DISPlay[:WINDow[1]|2]:METEr:UPPer <numeric_value>

The units used are dependent on the current setting of UNIT:POWer and CALCulate:RELative:STATe as shown in the following table:

Table 0-8: Measurement Units

Measurement Mode	Measurement Type	CALC:REL:STAT OFF		CALC:REL:STAT ON	
		Linear	Log	Linear	Log
Single Channel	Avg, Pk	Watt	dBm	%	dB
	Pk-Avg	%	dB	%	dB
Ratio	Avg, Pk, Pk-Avg	%	dB	%	dB
Difference	Avg, Pk	Watt	dBm	%	dB
	Pk-Avg	%	dB	%	dB

Syntax

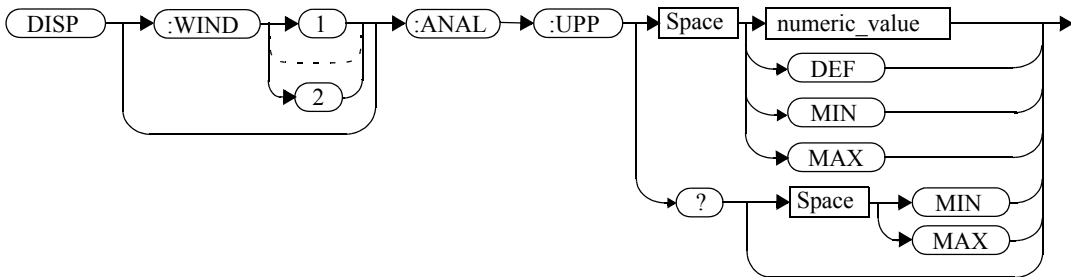

Parameters

Item	Description/Default	Range of Values
numeric_value	<p>A numeric value for the analog meter upper scale limit:</p> <ul style="list-style-type: none"> • DEF: the default is 20 dBm • MIN: -150 dBm • MAX: 230 dBm <p>Units used are determined by the current setting of UNIT:POWer and CALCulate:RELative:STATe as shown in the previous table.</p>	<p>-150 to 230 dBm</p> <p>DEF</p> <p>MIN</p> <p>MAX</p>

Example

DISP:WIND2:ANAL:UPP 50

This command sets the lower window's analog meter upper scale limit to 50 dBm

Reset Condition

On reset, the upper scale limit is set to 20 dBm.

Query

DISPlay: [WINDow[1] | 2]:ANALog:UPPer [MIN | MAX]

The query returns the current setting of the analog meter's upper scale limit, or the value associated with MIN or MAX. The format of the response is <NR3>. The units in which the results are returned are determined by the current setting of UNIT:POWer and CALCulate:RELative:STATe as shown in Table 0-8.

Query Example

DISP:WIND2:ANAL:UPP?

This command queries the upper scale limit set on the analog meter in the lower window

DISPlay[:WINDow[1]|2]:FORMat <character_data>

This command selects the format of the selected window.

Syntax

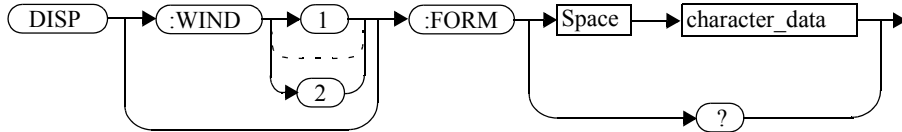

Parameters

Item	Description/Default	Range of Values
character_data	Sets the window format: <ul style="list-style-type: none"> • DIGital: sets the window display to digital. This setting is the same as SNUMeric. • ANALog: sets the window display to analog using the currently SElected measurement. • SNUMeric: sets the window display to single numeric. The currently SElected measurement is displayed. This setting is the same as DIGital. • DNUMeric: sets the window display to dual numeric. • TRACe: trace display using the currently SElected measurement. Used to determine the channel from which the trace will be taken. 	DIGital ANALog SNUMeric DNUMeric TRACe

Example

DISP:WIND2:FORM DIG

This command sets the lower window to a digital display.

Reset Condition

On reset, the E4416A power meter upper window is DIGi tal and the lower window ANALog. For theE4417A power meter, the defaults for the upper and lower windows are DIGi tal.

Query

DISPlay: [WINDow[1] | 2] :FORMat?

The query returns the current format of the selected window.

Query Example

DISP:FORM?

This command queries the current format of the upper window.

Error Messages

- If the command is set to TRACe and the selected channel from which TRACe is taken has no sensor connected or has a non E9320 sensor connected, error -241, “Hardware missing” occurs.
- If the command is set to TRACe and the selected channel has an E9320 sensor connected in AVERage measurement mode, the error -221, “Settings conflict” occurs.

DISPlay[:WINDow[1]|2]:METer Commands

These commands control the upper and lower scale limits of the analog meter.

The following commands are detailed in this section:

```
DISPlay[:WINDow[1]|2]:METer:LOWer <numeric_value>
```

```
DISPlay[:WINDow[1]|2]:METer:UPPer <numeric_value>
```

DISPlay[:WINDow[1]|2]:METer:LOWer <numeric_value>

This command sets the analog meter lower scale limit.

Note

This command has the same purpose as
 DISPlay[:WINDow[1]|2]:ANALog:LOWer <numeric_value>

The units used are dependent on the current setting of UNIT:POWER and CALCulate:RELative:STATE as shown in the following table:

Table 0-9: Measurement Units

Measurement Mode	Measurement Type	CALC:REL:STAT OFF		CALC:REL:STAT ON	
		Linear	Log	Linear	Log
Single Channel	Avg, Pk	Watt	dBm	%	dB
	Pk-Avg	%	dB	%	dB
Ratio	Avg, Pk, Pk-Avg	%	dB	%	dB
Difference	Avg, Pk	Watt	dBm	%	dB
	Pk-Avg	%	dB	%	dB

Syntax

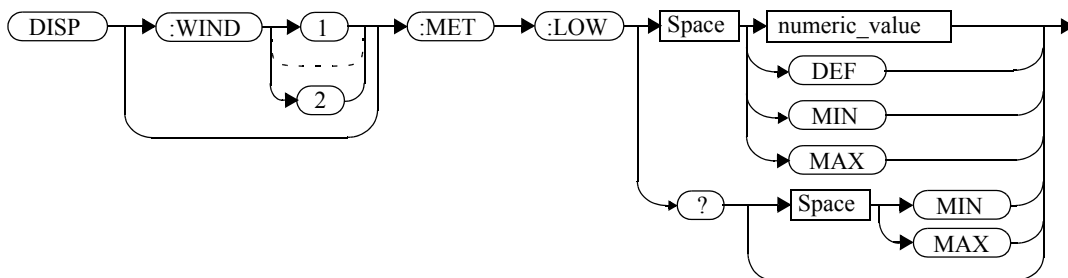

Parameters

Item	Description/Default	Range of Values
numeric_value	<p>A numeric value for the analog meter lower scale limit.</p> <ul style="list-style-type: none"> • DEF: the default value is -70 dBm. • MIN: -150 dBm. • MAX: 230 dBm. <p>The default units are defined by UNIT:POWer and CALCulate:RELative:STATE.</p>	<p>-150 to 230 dBm</p> <p>DEF</p> <p>MIN</p> <p>MAX</p>

Example

```
DISP:WIND2:MET:LOW 10
```

This command sets the lower window's analog meter lower scale limit.

Reset Condition

On reset, the lower scale limit is set to -70 dBm.

Query

```
DISPlay[:WINDow[1]|2]:METer:LOWer? [MIN|MAX]
```

The query returns the current setting of the analog meter's lower scale limit or the value associated with MIN and MAX. The format of the response is <NR3>. The units in which the results are returned is dependent on the current setting of UNIT:POWer and CALCulate:RELative:STATE as shown in the previous table.

Query Example

```
DISP:MET:LOW?
```

This command queries the lower scale limit set on the analog meter in the upper window.

DISPlay[:WINDow[1]|2]:METer:UPPer <numeric_value>

This command sets the analog meter upper scale limit.

Note

This command has the same purpose as
 DISPlay[:WINDow[1]|2]:ANALog:UPPer <numeric_value>

The units used are dependent on the current setting of UNIT:POWER and CALCulate:RELative:STATE as shown in the following table:

Table 0-10: Measurement Units

Measurement Mode	Measurement Type	CALC:REL:STAT OFF		CALC:REL:STAT ON	
		Linear	Log	Linear	Log
Single Channel	Avg, Pk	Watt	dBm	%	dB
	Pk-Avg	%	dB	%	dB
Ratio	Avg, Pk, Pk-Avg	%	dB	%	dB
Difference	Avg, Pk	Watt	dBm	%	dB
	Pk-Avg	%	dB	%	dB

Syntax

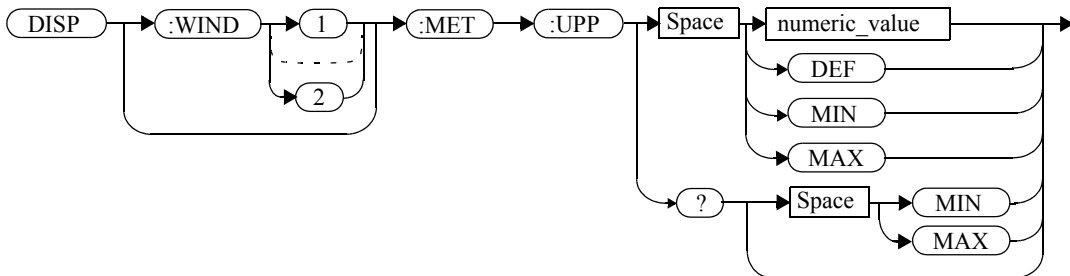

Parameters

Item	Description/Default	Range of Values
numeric_value	<p>A numeric value for the analog meter upper scale limit:</p> <ul style="list-style-type: none"> • DEF: the default is 20 dBm. • MIN: -150 dBm. • MAX: 230 dBm. <p>Units used are determined by the current setting of UNIT:POWER and CALCulate:RELative:STATE as shown in Table 0-10.</p>	<p>-150 to 230 dBm</p> <p>DEF</p> <p>MIN</p> <p>MAX</p>

Example

```
DISP:WIND2:MET:UPP 20
```

This command sets the lower window's analog meter upper scale limit.

Reset Condition

On reset, the upper scale limit is set to 20 dBm.

Query

```
DISPlay[:WINDow[1]|2]:METer:UPPer? [MIN|MAX]
```

The query returns the current setting of the analog meter's upper scale limit or the value associated with MIN and MAX. The format of the response is <NR3>. The units in which the results are returned is dependent on the current setting of UNIT:POWER and CALCulate:RELative:STATE as shown in the previous table.

Query Example

```
DISP:WIND2:MET:UPP?
```

This command queries the upper scale limit set on the analog meter in the lower window.

DISPlay[:WINDow[1]|2][:NUMeric[1]|2]:RESolution <numeric_value>

This command sets the resolution of the measurement result in the specified window.

Syntax

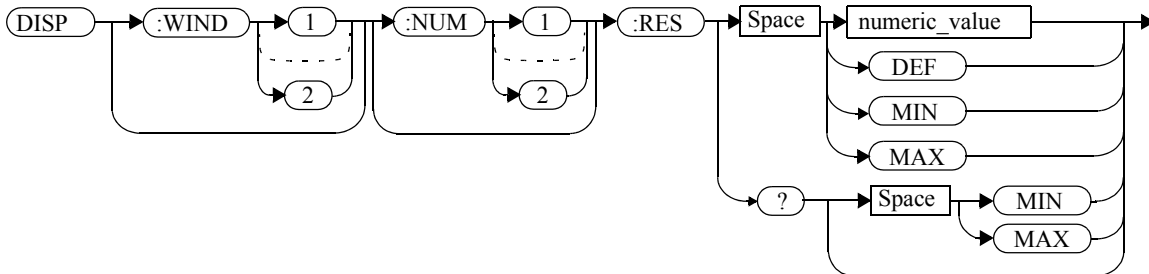

Parameters

Item	Description/Default	Range of Values
numeric_value	A numeric value for the window resolution: <ul style="list-style-type: none"> • DEF: 3 • MIN: 1 • MAX: 4 	1 to 4 DEF MIN MAX

Example

DISP:WIND2:RES 4

This command sets the lower window's resolution to four significant digits if the measurement result is linear, or to 0.001 if the measurement result is logarithmic.

Reset Condition

On reset, the resolution is set to 3.

Query

DISPlay[:WINDow[1]|2]:RESolution? [MIN|MAX]

DISPlay Subsystem

DISPlay[:WINDow[1][2][:NUMer[1][2]:RESolution <numeric_value>

The query returns the current setting of the window's resolution or the value associated with MIN and MAX. The format of the response is <NR1>.

Query Example

DISP:RES?

This command queries the resolution setting of the upper window.

DISPlay[:WINDow[1]|2]:SElect[1]|2

This command is used to select a specific measurement within a specific window.

If the second numeric value is not sent, the upper measurement of the relevant window is selected. This command is used to specify which measurement will be used for the analog, trace, or single numeric display.

Syntax

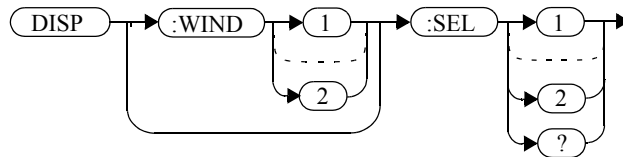

Example

```
DISP:WIND2:SEL1
```

This command selects the upper measurement in the lower window.

Reset Condition

On reset, the upper window upper measurement is selected.

Query

```
DISPlay[:WINDow[1]|2]:SElect[1]|2?
```

The query enters a 1 or 0 into the output buffer indicating whether the window specified is currently selected.

- 1 is returned if the specified window is selected.
- 0 is returned if the specified window is not selected.

Query Example

```
DISP:SEL1?
```

This command queries whether or not the upper measurement in the upper window is selected.

DISPlay[:WINDow[1]|2][:STATe] <boolean>

This command enables/disables the upper or lower window (WINDow1 and WINDow2 respectively) so that the display shows a single window only. The displayed window is presented in expanded format, showing a single measurement only: either the single measurement that was shown on the window, or the currently selected measurement, if two measurements had been shown.

Syntax

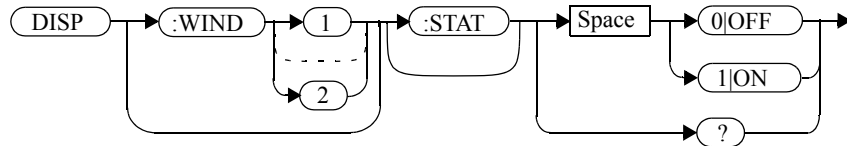

Examples

DISP:WIND2:STAT OFF

This command disables the lower window. The upper window is shown in expanded format, displaying its currently selected measurement.

DISP:WIND2:STAT 1

This command enables the lower window so that a dual window display is once more provided.

Reset Condition

On reset, both windows are enabled.

Query

DISPlay[:WINDow[1]|2]:STATe?

The query enters a 1 or 0 into the output buffer indicating the state of the selected window.

- 1 is returned if the window is enabled.

- 0 is returned if the window is disabled.

Query ExampleQuery Example

DISP:WIND2:STAT?

*This command queries whether or not
the lower window is displayed.*

DISPlay[:WINDow[1]|2]:TRACe:FEED <character_data>

This command selects which channel's trace is displayed in the specified window.

Syntax

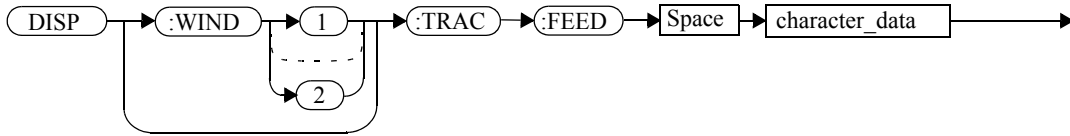

Parameters

Item	Description/Default	Range of Values
character_data	Identifies which channel's trace is displayed. <ul style="list-style-type: none"> • SENS1: channel A. • SENS2: channel B. 	"SENS1" "SENS2"

Example

DISP : WIND2 : TRAC : FEED
"SENS1"

This command selects channel A's trace to be displayed in the lower window.

Reset Condition

On reset, the value is set to:

- Upper window: SENS1.
- Lower window (dual channel only): SENS2.

Query

DISPlay: [WINDow[1] | 2] : TRACe: FEED?

The query returns the channel of the trace currently displayed in the specified window.

Query Example

```
DISP:WIND2:TRAC:FEED?
```

This command queries the channel of the trace currently displayed in the lower window.

DISPlay[:WINDow[1]|2]:TRACe:LOWer <numeric_value>

This command sets the trace window lower scale limit.

Note This command is included for compatibility purposes only. It has the same purpose as
 SENSE[1]|2:TRACe:LIMit:LOWer <numeric_value>
 which should be used in preference.

The units used are dependent on the current setting of SENS : TRAC : UNIT as shown in the following table:

Table 0-11: Measurement Units

Units: SENS:TRAC:UNIT	Units: DISPlay[:WINDow[1] 2]:TRACe:LOWer
dBm	dBm
W	W

Syntax

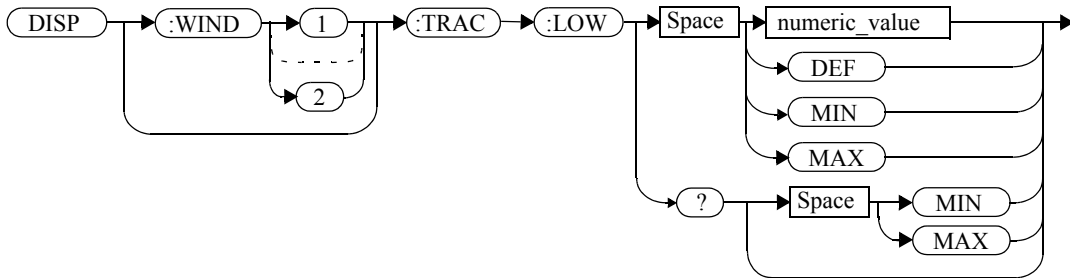

Parameters

Item	Description/Default	Range of Values
numeric_value	<p>A numeric value for the trace window lower scale limit.</p> <ul style="list-style-type: none"> • DEF: the default is 20 dBm • MIN: -150 dBm • MAX: 230 dBm <p>Units used are resolved to 1 dBm</p>	<p>-150 to 230 dBm</p> <p>DEF</p> <p>MIN</p> <p>MAX</p>

Example

DISP:WIND2:TRAC:LOW 10

This command sets the trace window lower scale limit to 10 dBm

Reset Condition

On reset, the value is set to -50 dBm.

Query

DISPlay: [WINDow[1] | 2]:TRACe:UPPer [MIN|MAX]

The query returns the current setting of the trace window lower scale limit or the value associated with MIN or MAX. The format of the response is <NR3>.

Query Example

DISP:WIND2:TRAC:LOW?

This command queries the trace window lower scale limit of the lower window

DISPlay[:WINDow[1]|2]:TRACe:UPPer <numeric_value>

This command sets the trace window upper scale limit.

Note This command is included for compatibility purposes only. It has the same purpose as
SENSe[1] | 2:TRACe:LIMit:UPPer <numeric_value>
 which should be used in preference.

The units used are dependent on the current setting of **SENS : TRAC : UNIT** as shown in the following table:

Table 0-12: Measurement Units

Units: SENS:TRAC:UNIT	Units: DISPlay[:WINDow[1] 2]:TRACe:UPPer
dBm	dBm
W	W

Syntax

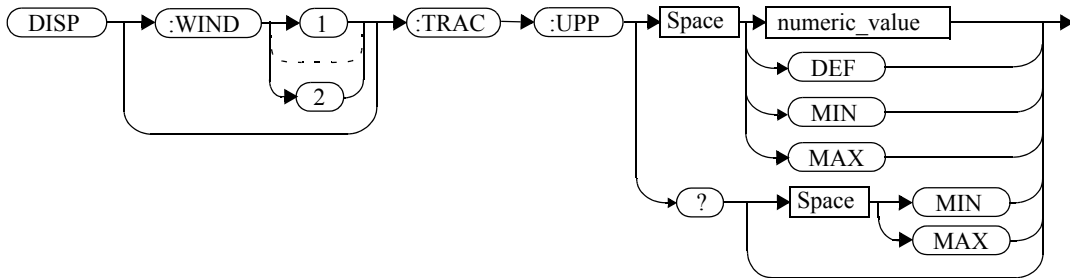

Parameters

Item	Description/Default	Range of Values
numeric_value	<p>A numeric value for the trace window upper scale limit.</p> <ul style="list-style-type: none"> • DEF: the default is 20 dBm • MIN: -150 dBm • MAX: 230 dBm <p>Units used are resolved to 1 dBm</p>	<p>-150 to 230 dBm</p> <p>DEF</p> <p>MIN</p> <p>MAX</p>

Example

`DISP:WIND2:TRAC:UPP 100` *This command sets the trace window upper scale limit to 100 dBm*

Reset Condition

On reset, the value is set to 20 dBm.

Query

`DISPlay: [WINDow[1] | 2]:TRACe:UPPer [MIN|MAX]`

The query returns the current setting of the trace window upper scale limit or the value associated with MIN or MAX. The format of the response is <NR3>.

Query Example

`DISP:WIND2:TRAC:UPP?` *This command queries the trace window upper scale limit of the lower window*

DISPlay Subsystem

DISPlay[:WINDow[1]|2]:TRACe:UPPer <numeric_value>

THIS PAGE HAS BEEN INTENTIONALLY LEFT BLANK.

6

———— **FORMat Subsystem**

FORMat Subsystem

The FORMat subsystem sets a data format for transferring numeric information. This data format is used only for response data by commands that are affected by the FORMat subsystem.

The queries affected are:

- FETCh?
- READ?
- MEASure?

For the E4417A power meter the same FORMat is used on both channels.

Keyword	Parameter Form	Notes	Page
FORMat			
[:READings]			
:BORDer	<character_data>		page 6-3
[:DATA]	<character_data>		page 6-4

FORMat[:READings]:BORDER <character_data>

This command controls whether the binary data is transferred in normal or swapped Byte ORDER. It is only used when FORMat [: READings] [: DATA] is set to REAL.

Syntax

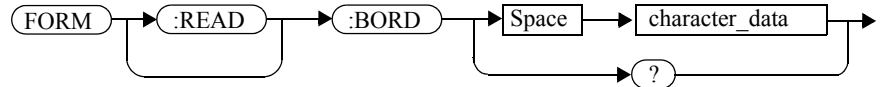

Parameters

Item	Description/Default	Range of Values
character_data	Byte order of binary data transfer: <ul style="list-style-type: none"> • NORMAl • SWAPped 	NORMAl SWAPped

Example

FORM:BORD SWAP

This command sets the byte order to swapped.

Reset Condition

On reset, this value is set to NORMAl.

Query

FORMat [: READings] :BORDER?

The query returns the current setting of the byte order. The format of the response is NORMAl or SWAPped.

Query Example

FORM:BORD?

This command queries the current byte order setting.

FORMat[:READings][:DATA] <character_data>

This command sets the data format for transferring numeric information to either `ASCIi` or `REAL`:

- When the format type is `ASCIi`, numeric data is output as ASCII bytes in the `<NR3>` format.
- When the format type is `REAL`, numeric data is output as IEEE 754 64 bit floating point numbers in a definite length block. The result is an 8 byte block per number. Each complete block is terminated by a line feed character.

For the E4417A power meter the same `FORMat` is used on both channels.

Note `FORMat` data formatting is not affected by `TRACe` subsystem data formatting.

Syntax

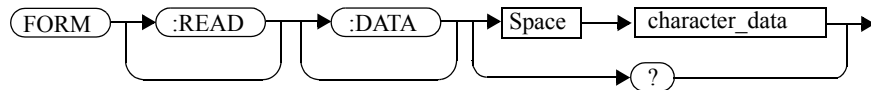

Parameters

Item	Description/Default	Range of Values
character_data	Data format for transferring data: <ul style="list-style-type: none"> • <code>ASCIi</code> • <code>REAL</code> 	<code>ASCIi</code> <code>REAL</code>

Example

`FORM REAL`

This command sets the format to `REAL`.

Reset Condition

On reset, the format is set to `ASCIi`.

Query

FORMat [:READings] [:DATA] ?

The query returns the current setting of format: either ASCii or REAL.

Query Example

FORM?

This command queries the current format setting.

FORMat Subsystem
FORMat[:READings][:DATA] <character_data>

THIS PAGE HAS BEEN INTENTIONALLY LEFT BLANK.

7

———— **MEMory Subsystem**

MEMory Subsystem

The MEMory command subsystem is used to:

- Edit and review sensor calibration tables (8480 Series power sensors and N8480 Series sensors with Option CFT only).
- Store sensor calibration tables (8480 Series power sensors and N8480 Series sensors with Option CFT only).
- Edit and review sensor frequency dependent offset tables.
- Store sensor frequency dependent offset tables.
- Edit and review sensor save/recall registers.

Stored tables remain in the power meter's memory during power down. The power meter is capable of storing 20 sensor calibration tables and 10 frequency dependent offset tables of 80 frequency points each.

Note

The MEMory subsystem is not used for E-Series power sensors and N8480 Series power sensors (excluding Option CFT) calibration tables which are automatically downloaded to the power meter and cannot be reviewed or edited.

Keyword	Parameter Form	Notes	Page
MEMory			
:CATalog			
[:ALL]?		[query only]	page 7-5
:STATe?		[query only]	page 7-7
:TABLE?		[query only]	page 7-8
:CLEar			
[:NAME]	<character_data>	[no query], [non-SCPI]	page 7-11
:TABLE		[no query]	page 7-12
:FREE			
[:ALL]?		[query only]	page 7-14
:STATe?		[query only]	page 7-15
:TABLE?		[query only]	page 7-16
:NSTATes?		[query only]	page 7-17
:STATe			
:CATalog?		[query only]	page 7-19
:DEFine	<character_data> [, <numeric_value>]	[non-SCPI]	page 7-20
:TABLE			
:FREQuency	<numeric_value> [, <numeric_value>]		page 7-22
:POINTs?		[query only]	page 7-25

Keyword	Parameter Form	Notes	Page
:GAIN			
[:MAGNitude]	<numeric_value>	[non-SCPI]	page 7-26
	[, <numeric_value>]		
:POINTs?		[query only], [non-SCPI]	page 7-28
:MOVE	<character_data> ,	[no query],	page 7-29
	<character_data>	[non-SCPI]	
:SElect	<character_data>	[no query], [non-SCPI]	page 7-30

MEMory:CATalog Commands

These commands are used to query information on the current contents of a power meter's:

- Sensor calibration tables (8480 Series power sensors and N8480 Series sensors with Option CFT only).
- Frequency dependent offset tables.
- Save/recall registers.

The following commands are detailed in this section:

MEMory:CATalog[:ALL]?

MEMory:CATalog:STATe?

MEMory:CATalog:TABLE?

MEMory:CATalog[:ALL]?

This command lists stored sensor calibration tables (8480 Series power sensors and N8480 Series sensors with Option CFT only), frequency dependent offset tables and save/recall registers.

The power meter returns the data in the form of two numeric parameters and as many strings as there are stored tables and save/recall registers:

<numeric_value>, <numeric_value>{, <string>}

- The first numeric parameter indicates the amount of memory, in bytes, used for the storage of tables and registers.
- The second numeric parameter indicates the memory, in bytes, available for the storage of tables and registers.
- Each string parameter returned indicates the name, type and size of a stored table or save/recall register:
 - <string>, <type>, <size>
 - ◆ <string> indicates the name of the table or save/recall register.
 - ◆ <type> indicates *TABL* for sensor calibration and frequency dependent offset tables, or *STAT* for a save/recall register.
 - ◆ <size> indicates the size of the table or save/recall register in bytes.

A sample of a response may look like the following:

```
1178, 26230, "DEFAULT, TABL, 14", "HP8481A, TABL, 116",  
"HP8482A, TABL, 74", ..... "State0, STAT, 1619",  
"State1, STAT, 1619", "State2, STAT, 1619" .....
```

Note

Predefined sensor calibration table is not applicable for N8480 Series power sensors with Option CFT. Therefore you are required to create a new sensor calibration table for the sensors when a sensor calibration table is needed.

The power meter is shipped with a set of predefined sensor calibration tables. The data in these sensor calibration tables is based on statistical averages for a range of

MEMory Subsystem
MEMory:CATalog[:ALL]?

Agilent Technologies power sensors. These tables can be altered. The predefined data is listed in your *User's Guide*. These power sensors are:

Table	Power Sensor	Table Name
0	None	DEFAULT ¹
1	8481A	HP8481A
2	8482A, 8482B, 8482H	HP8482A
3	8483A	HP8483A
4	8481D	HP8481D
5	8485A	HP8485A
6	R8486A	R8486A
7	Q8486A	Q8486A
8	R8486D	R8486D
9	8487A	HP8487A

1. Default is a sensor calibration table in which the reference calibration factor and calibration factors are 100%. This sensor calibration table can be used during the performance testing of the power meter.

There are also ten sensor calibration tables named CUSTOM_0 through CUSTOM_9 and ten frequency dependent offset tables named CUSTOM_A through CUSTOM_J which do not contain any data when the power meter is shipped from the factory.

Syntax

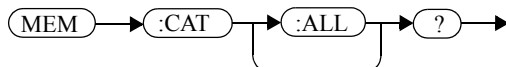

Example

MEM : CAT?

This command queries the list of tables and save/recall registers.

MEMory:CATalog:STATe?

This command is used to list the save/recall registers.

The power meter returns the data in the form of two numeric parameters and as many strings as there are save/recall registers.

`<numeric_value>, <numeric_value>{, <string>}`

- The first numeric parameter indicates the amount of memory, in bytes, used for the storage of registers.
- The second parameter indicates the memory, in bytes, available for the storage of registers.
- Each string parameter returned indicates the name, type and size of a save/recall register:
 - `<string>, <type>, <size>`
 - ◆ `<string>` indicates the name of the save/recall register.
 - ◆ `<type>` indicates `STAT` for save/recall register.
 - ◆ `<size>` indicates the size of the save/recall register in bytes.

For example, a sample of a response may look like:

`0, 16190, "State0, STAT, 0", "State1, STAT, 0"`

Syntax

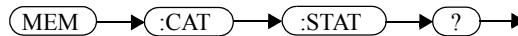

Example

`MEM:CAT:STAT?`

This command queries the list of save/recall registers.

MEMory:CATalog:TABLE?

This command is used to list the stored sensor calibration (8480 Series power sensors and N8480 Series sensors with Option CFT only) and frequency dependent offset tables.

The power meter returns the data in the form of two numeric parameters and as many strings as there are stored tables.

`<numeric_value>, <numeric_value>{, <string>}`

- The first numeric parameter indicates the amount of memory, in bytes, used for the storage of tables.
- The second parameter indicates the memory, in bytes, available for the storage of tables.
- Each string parameter returned indicates the name, type and size of a stored table:
 - `<string>, <type>, <size>`
 - ◆ `<string>` indicates the name of the table.
 - ◆ `<type>` indicates TABL for a table.
 - ◆ `<size>` indicates the size of the table in bytes.

For example, a sample of a response may look like:

```
1178, 10040, "DEFAULT, TABL, 14", "HP8481A, TABL, 116",  
"HP8482A, TABL, 74", "HP8483A, TABL, 62" .....
```

Note

Predefined sensor calibration table is not applicable for N8480 Series power sensors with Option CFT. Therefore you are required to create a new sensor calibration table for the sensors when a sensor calibration table is needed.

The power meter is shipped with a set of predefined sensor calibration tables. The data in these sensor calibration tables is based on statistical averages for a range of Agilent power sensors. These tables can be altered. The predefined data is listed in your *User's Guide*. These power sensors are:

Table	Power Sensor	Table Name
0	None	DEFAULT ¹
1	8481A	HP8481A
2	8482A, 8482B, 8482H	HP8482A
3	8483A	HP8483A
4	8481D	HP8481D
5	8485A	HP8485A
6	R8486A	R8486A
7	Q8486A	Q8486A
8	R8486D	R8486D
9	8487A	HP8487A

1. Default is a sensor calibration table in which the reference calibration factor and calibration factors are 100%. This sensor calibration table can be used during the performance testing of the power meter.

There are also ten sensor calibration tables named CUSTOM_0 through CUSTOM_9 and ten frequency dependent offset tables named CUSTOM_A through CUSTOM_J which do not contain any data when the power meter is shipped from the factory.

Syntax



Example

MEM:CAT:TABL?

This command queries the list of stored tables.

MEMory:CLEar Commands

These commands are used to remove the contents stored in the sensor calibration tables (8480 Series power sensors and N8480 Series sensors with Option CFT only), frequency dependent offset tables and save/recall registers. This subsystem removes the data contents but does not affect the name of the associated table or save/recall register.

The following commands are detailed in this section:

MEMory:CLEar:[NAME] <character_data>

MEMory:CLEar:TABLE

Note

The contents cleared using these commands are non-recoverable.

MEMory:CLEar[:NAME] <character_data>

This command clears the contents of a specified sensor calibration table (8480 Series power sensors and N8480 Series sensors with Option CFT only), frequency dependent offset table, or save/recall register.

Although the table remains, a `MEMory:TABLE:FREQUENCY|GAIN:POINTS?` query returns a 0 as there are no contents in the table.

For sensor calibration tables and frequency dependent offset tables, this command is an alternative form of the `MEMory:CLEar:TABLE` command, the only difference being the method in which the table is selected.

Note The contents cleared using this command are non-recoverable.

Syntax

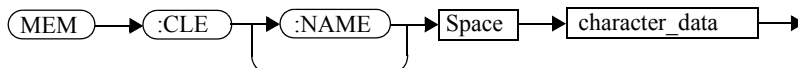

Parameters

Item	Description/Default	Range of Values
character_data	Contains an existing table name or save/recall register.	Any existing table name or save/recall register.

Example

`MEM:CLE "HP8485A"`

This command clears the contents of sensor calibration table HP 8485A

Error Messages

If the table or save/recall register name does not exist, error -224, “Illegal parameter value” occurs.

MEMory:CLEAr:TABLE

This command is used to clear the contents of the table currently selected using `MEMory:TABLE:SElect`. Although the table remains, a `MEMory:TABLE:FREQuency|GAIN:POINTs?` query returns a 0 as there are no contents in the table.

This command is an alternative form of the `MEMory:CLEAr[:NAME]` command, the only difference being the method in which the table is selected.

Note The contents cleared using this command are non-recoverable.

Syntax



Example

`MEM:CLE:TABL`

This command clears the contents of the currently selected table.

Error Message

If no table is selected, error -221, “Settings conflict” occurs.

The MEMory:FREE Commands

These commands are used to return information on the amount of free memory space available for sensor calibration tables (8480 Series power sensors and N8480 Series sensors with Option CFT only), frequency dependent offset tables, and save/recall registers.

The following commands are described in this section:

MEMory:FREE[:ALL]?

MEMory:FREE:STATe?

MEMory:FREE:TABLE?

MEMory:FREE[:ALL]?

This query returns the amount of memory free for sensor calibration tables (8480 Series power sensors and N8480 Series sensors with Option CFT only), frequency dependent offset tables, and save/recall registers. The format of the response is:

<bytes_available>, <bytes_in_use>

Syntax

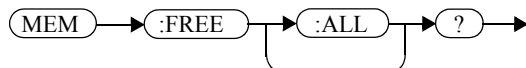

Example

MEM:FREE?

This command queries the amount of free memory in total.

MEMory:FREE:STATe?

This query returns the amount of memory free for save/recall registers. The format of the response is:

<bytes_available>, <bytes_in_use>

Syntax

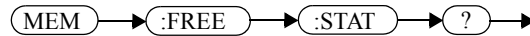

Example

MEM:FREE:STAT?

This command queries the amount of free memory for save/recall registers.

MEMory:FREE:TABLE?

This query returns the amount of memory free for sensor calibration tables (8480 Series power sensors and N8480 Series sensors with Option CFT only) and frequency dependent offset tables. The format of the response is:

<bytes_available>, <bytes_in_use>

Syntax

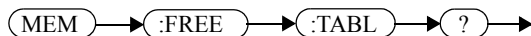

Example

MEM:FREE:TABLE?

This command queries the amount of free memory for tables.

MEMory:NSTates?

This query returns the number of registers that are available for save/recall. As there are ten registers this query always returns ten.

Syntax



Example

MEM: NST?

This command queries the number of registers available for save/recall.

The MEMory:STATe Commands

These commands are used to query and define register names.

The following commands are described in this section:

MEMory:STATe:CATalog?

MEMory:STATe:DEFine

MEMory:STATe:CATalog?

This query returns a list of the save/recall register names in ascending order of register number. The format of the response is:

<string>, <string>, , <string>

Syntax

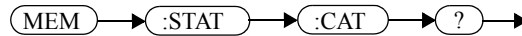

Example

MEM:STAT:CAT?

This command queries the register names.

MEMory:STATe:DEFine <character_data>,<numeric_value>

This command is used to associate a name with a save/recall register number.

Syntax

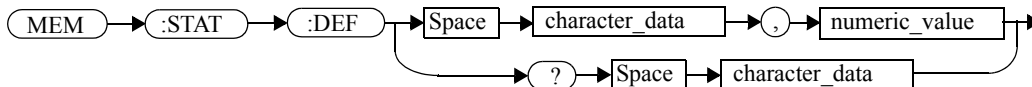

Parameters

Item	Description/Default	Range of Values
character_data	Details the register name. A maximum of 12 characters can be used.	A to Z (uppercase) a to z (lowercase) 0 - 9 _ (underscore)
numeric_value	A numeric value (<NRf>) for the register number.	0 to 9

Example

```
MEM:STAT:DEF "SETUP1",4
```

This command names register 4 SETUP1.

Query

```
MEMory:STATe:DEFine? <string>
```

The query returns the register number for the given register name.

Query Example

```
MEM:STAT:DEF? "SETUP1"
```

This command queries the register number of SETUP1.

Error Messages

- If the register number is out of range, error -222, “Data out of range” occurs.
- If the name is invalid, error -224, “Illegal parameter value” occurs.
- If a register or sensor calibration table with the same name already exists, error -257, “File name error” occurs (command only).

MEMory:TABLE Commands

These commands are used to define a sensor calibration table (8480 Series power sensors and N8480 Series sensors with Option CFT only) or a frequency dependent offset table, and to write to and read data from it.

The following commands are described in this section:

```
MEMory:TABLE:FREQuency <numeric_value>{,<numeric_value>}
```

```
MEMory:TABLE:FREQuency:POINts?
```

```
MEMory:TABLE:GAIN[:MAGNitude]
```

```
    <numeric_value>{,<numeric_value>}
```

```
MEMory:TABLE:GAIN[:MAGNitude]:POINts?
```

```
MEMory:TABLE:MOVE <character_data>,<character_data>
```

```
MEMory:TABLE:SElect <character_data>
```

MEMory:TABLE:FREQUENCY <numeric_value>{,<numeric_value>}

This command is used to enter frequency data into the current selected table. Any previous frequency list is cleared before the new frequencies are stored. The frequencies must be entered in ascending order. Entries in the frequency lists correspond as shown with entries in the calibration/offset factor lists. Note, that for sensor calibration tables only, the first calibration factor entered using the `MEMory:TABLE:GAIN` command is used as the reference calibration factor.

Frequency	Calibration Factor/Offset
-	Reference Calibration Factor (For Sensor Calibration Tables)
Frequency 1	Calibration Factor/Offset 1
Frequency 2	Calibration Factor/Offset 2
"	"
Frequency 80	Calibration Factor/Offset 80

For sensor calibration tables (8480 Series power sensors and N8480 Series sensors with Option CFT only), the number of frequency points must be one less than the number of calibration factor points. This is verified when the sensor calibration table is selected using `SENSE:CORREction:CSET:SElect <string>`.

Ensure that the frequency points you use cover the frequency range of the signals that you want to measure. If you measure a signal with a frequency outside the frequency range defined in the table, then the power meter uses the highest or lowest point in the table to calculate the calibration factor/offset.

Depending on available memory, the power meter is capable of storing 20 sensor calibration tables and 10 frequency dependent offset tables, each containing 80 points.

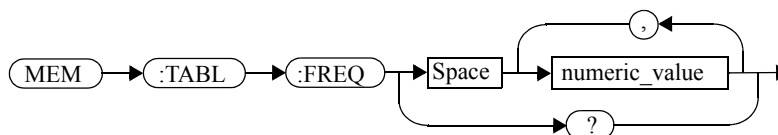
Syntax

Parameters

Item	Description/Default	Range of Values
numeric_value	A numeric value for the frequency. The default units are Hz.	1 kHz to 999.9 GHz ¹ , 2

1. The following measurement units can be used:
 - Hz
 - kHz (10³)
 - MHz (10⁶)
 - GHz (10⁹)
2. All frequencies are truncated to a multiple of 1 kHz.

Example

`MEM:TABLE:FREQ 200kHz,600kHz` *This command enters frequencies of 200 kHz and 600 kHz into the currently selected table.*

Query

`MEMory:TABLE:FREQuency?`

The query returns a list of frequency points for the table currently selected. The frequencies are returned in Hz.

Query Example

`MEM:TABLE:FREQ?` *This command queries the frequency points in the currently selected table.*

Error Messages

- If more than 80 frequencies are in the list, error -108, “Parameter not allowed” occurs.
- If the frequencies are not entered in ascending order, error -220, “Parameter error;Frequency list must be in ascending order” occurs.
- If a table has not been specified using the MEMory:TABLE:SElect command, the data cannot be entered into the table and error -221, “Settings conflict” occurs.
- If a frequency is sent which is outside of the allowed frequency range, error -222, “Data out of range” occurs.

MEMory:TABLE:FREQuency:POINts?

This query returns the number of frequency points for the table currently selected. The response format is <NRf>. If no frequency values have been set, this command returns 0. If no table is selected, this command returns NAN.

Syntax



Example

MEM:TABLE:FREQ:POIN?

This command queries the number of frequency points in the current table.

MEMory:TABLE:GAIN[:MAGNitude] <numeric_value>{,<numeric_value>}

This command is used to enter calibration factors into the sensor calibration table (8480 Series power sensors and N8480 Series sensors with Option CFT only) or offsets into the frequency dependent offset table, currently selected using `MEMory:TABLE:SElect`. Any previous calibration factor list, or offset list is cleared before the new calibration factors/offsets are stored.

A maximum of 81 parameters for sensor calibration tables and 80 parameters for frequency dependent offset tables can be sent with this command. For sensor calibration tables only, the first parameter is the reference calibration factor, each subsequent parameter is a calibration factor point in the sensor calibration table.

Entries in the frequency lists correspond as shown with entries in the calibration/offset factor lists.

Calibration Factor/Offset	Frequency
Reference Calibration Factor (Sensor Cal Table Only)	-
Calibration Factor/Offset 1	Frequency 1
"	"
Calibration Factor/Offset 80	Frequency 80

For sensor calibration tables the number of frequency points must be one less than the number of calibration factor data points. This is verified when the sensor calibration table is selected using `SENSE:CORREction:CSET1:SElect <string>`.

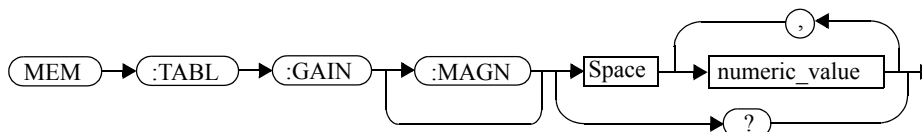
Syntax

Parameters

Item	Description/Default	Range of Values
numeric_value	A numeric value for the calibration/ offset factors. The units are PCT.	1.0 to 150.0

Example

```
MEM:TABLE:SEL "Sensor_1"
MEM:TABLE:GAIN 97,99.5,97.4
```

This command enters a reference calibration factor of 97% and calibration factors of 99.5% and 97.4% into the sensor calibration table.

Query

```
MEMory:TABLE:GAIN[:MAGNitude]?
```

The query returns a list of calibration factor/offset points for the currently selected table.

Query Example

```
MEM:TABLE:GAIN?
```

This command queries the calibration factor/offset in the current table.

Error Messages

- If more than 81 calibration factors for sensor calibration tables, or 80 offsets for frequency dependent offset tables are in the list, error -108, “Parameter not allowed” occurs.
- If a table is not specified using the MEMory:TABLE:SElect command, the data cannot be entered and error -221, “Settings conflict” occurs.
- If any of the calibration/offset factors are outside of the allowed range, error -222, “Data out of range” occurs.

MEMory:TABLE:GAIN[:MAGNitude]:POINts?

This query is used to return the number of calibration factor/offset points for the currently selected table. If the currently selected table is a sensor calibration table (8480 Series power sensors and N8480 Series sensors with Option CFT only), the reference calibration factor will be included

If no values have been set, 0 is returned. If no table is selected, NAN is returned.

Syntax

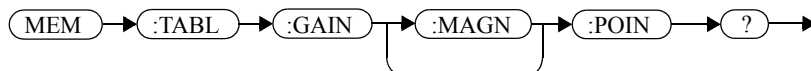

Example

MEM:TABLE:GAIN:POIN?

This command queries the number of calibration factor/offset points in the current table.

MEMory:TABLE:MOVE <character_data>,<character_data>

This command is used to rename a sensor calibration table (8480 Series power sensors and N8480 Series sensors with Option CFT only) or a frequency dependent offset table.

Syntax



Parameters

Item	Description/Default	Range of Values
character_data 1st parameter)	Contains the existing table name.	existing table name
character_data(2nd parameter)	Details the new table name. A maximum of 12 characters can be used.	A to Z (uppercase) a to z (lowercase) 0 - 9 _ (underscore)

Example

MEM:TABLE:MOVE "tab1" , "tab1a" *This command renames a table named tab1 to tab1a.*

Error Messages

- If either table name is invalid, error -224, “Illegal parameter value” occurs.
- If the first parameter does not match an existing table name, error -256, “File name not found” occurs.
- If the second parameter matches an existing table name or save/recall register, error -257, “File name error” occurs.

MEMory:TABLE:SElect <character_data>

This command is used to activate either a sensor calibration table (8480 Series power sensors and N8480 Series sensors with Option CFT only), or a frequency dependent offset table. A table must be activated before any operation can be performed on it.

Syntax

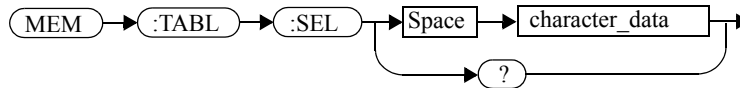

Parameters

Item	Description/Default	Range of Values
character_data	Details the table name. A maximum of 12 characters can be used.	A to Z (uppercase) a to z (lowercase) 0 - 9 _ (underscore)

Example

```
MEM:TABLE:SEL "Sensor1"
```

This command selects a sensor calibration table named "Sensor1".

Query

```
MEMory:TABLE:SElect?
```

The query returns the name of the currently selected table.

8

———— **OUTput Subsystem**

OUTPut Subsystem

The OUTPut command subsystem is used to switch on and off the POWER REF output and control the rear panel TTL outputs. The TTL Outputs can be used to determine when a predefined limit in either, or both, windows has been exceeded.

Keyword	Parameter Form	Notes	Page
OUTPut			
:REcOrder[1] 2			
:FEED	<data_handle>		page 8-3
:LIMit			
:LOWer	<numeric_value>		page 8-5
:UPPer	<numeric_value>		page 8-7
:STATe	<boolean>		page 8-9
:ROScillator			
[:STATe]	<boolean>		page 8-10
:TRIGger			
[:STATe]	<boolean>		page 8-11
:TTL[1] 2			
:ACTive	HIGH LOW		page 8-12
:FEED	<string>		page 8-14
:STATe	<boolean>		page 8-16

OUTPut:RECOder[1]|2:FEED <data_handle>

This command specifies which measurement is sent to the recorder output specified by the numeric value following RECOder. RECOder1 applies to both single and dual channel power meters. RECOder2 applies to dual channel power meters only.

Syntax

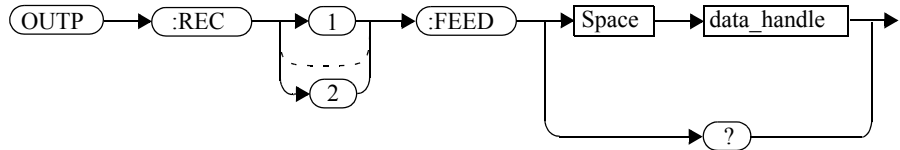

Parameters

Item	Description/Default	Range of Values
data_handle	The CALC block specifying the measurement to be sent to the recorder output.	"CALC1" or "CALC" "CALC2" "CALC3" "CALC4"

Example

OUTPut:RECOder2:FEED "CALC1" *This command sends the CALC1 measurement to recorder output 2.*

Reset Condition

On reset, data_handle is set to its previous value.

Query

OUTPut:RECOder[1]|2:FEED?

The query command returns the current value of data_handle.

Query Example

OUTP:REC2:FEED?

*This command queries the value of
data_handle for recorder output 2.*

OUTPut:RECOder[1]|2:LIMit:LOWer <numeric_value>

This command sets the minimum scaling value for the specified recorder output. The units used are dependent on the units currently set for the CALC block specified in `OUTPut:RECOder[1]|2:FEED <data_handle>`.

Syntax

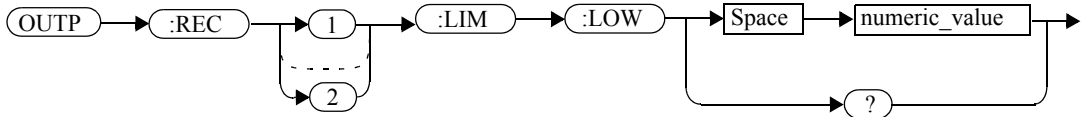

Parameters

Item	Description/Default	Range of Values
numeric_value	A numeric value for the minimum scaling value. The units used—dBm, W or %—are dependent on the units currently set for the CALC block specified in <code>OUTPut:RECOder[1] 2:FEED <data_handle></code> .	-150 to +20 dBm 1 aW to 100 mW 0% to 100%

Example

`OUTP:REC:LIM:LOW -90`

This command sets the minimum scaling value to -90.

Reset Condition

On reset, the minimum scaling value is set to -150 dBm.

Query

`OUTPut:RECOder[1]|2:LIMit:LOWer?`

The query command returns the minimum scaling value.

Query Example

OUTP:REC:LIM:LOW?

This command returns the minimum scaling value for the specified recorder output.

OUTPut:RECOder[1]2:LIMit:UPPer <numeric_value>

This command sets the maximum scaling value for the specified recorder output. The units used are dependent on the units currently set for the CALC block specified in `OUTPut:RECOder[1]2:FEED <data_handle>`.

Syntax

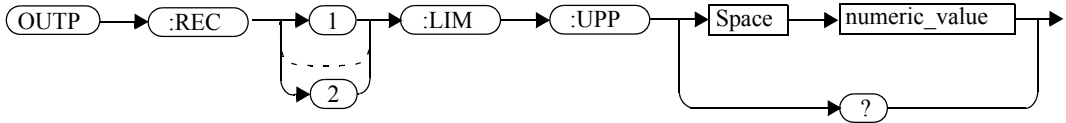

Parameters

Item	Description/Default	Range of Values
numeric_value	A numeric value for the maximum scaling value. The units used—dBm, W or %—are dependent on the units currently set for the CALC block specified in <code>OUTPut:RECOder[1]2:FEED <data_handle></code> .	-150 to +20 dBm 1 aW to 100 mW 0% to 100%

Example

`OUTPut:REC:LIM:UPP 10`

This command sets the maximum scaling value to 10.

Reset Condition

On reset, the maximum scaling value is set to +20 dBm.

Query

`OUTPut:RECOder[1]2:LIMit:UPPer?`

The query command returns the maximum scaling value.

Query Example

OUTP:REC:LIM:UPP?

This command returns the maximum scaling value for the specified recorder output.

OUTPut:RECOder[1]|2:STATe <boolean>

This command enables or disables the specified recorder output.

Syntax

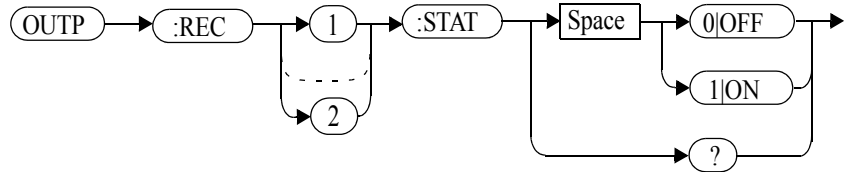

Example

```
OUTPut:REC1:STAT 1
```

This command enables the specified recorder output.

Reset Condition

On reset, the recorder output is OFF.

Query

```
OUTPut:RECOder[1]|2:STATe?
```

The query command enters a 1 or 0 into the output buffer indicating whether or not the specified recorder is switched on.

- 1 is returned when the recorder output is switched ON.
- 0 is returned when the recorder output is switched OFF.

Query Example

```
OUTPut:REC2:STAT?
```

This command queries the status of the recorder output.

OUTPut:ROSCillator[:STATe] <boolean>

This command enables/disables the POWER REF output.

Syntax

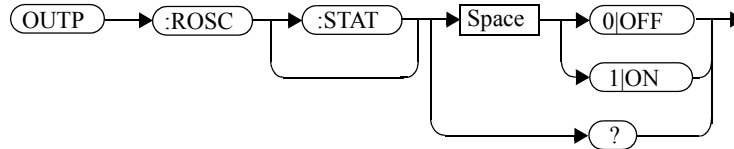

Example

```
OUTP:ROSC:STAT 1
```

This command enables the POWER REF output.

Reset Condition

On reset, the POWER REF output is disabled.

Query

```
OUTPut:ROSCillator[:STATe]?
```

The query command enters a 1 or 0 into the output buffer indicating whether or not the POWER REF is enabled.

- 1 is returned when the POWER REF output is enabled.
- 0 is returned when the POWER REF output is disabled.

Query Example

```
OUTP:ROSC?
```

This command queries the status of the POWER REF output.

OUTPut:TRIGger[:STATe] <boolean>

This command enables/disables the trigger output signal.

Syntax

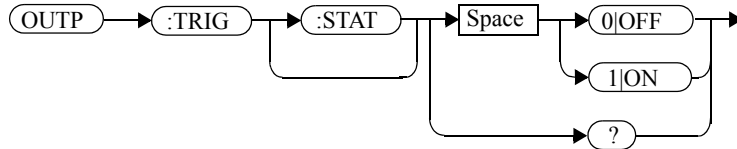

Example

```
OUTPut:TRIG:STAT 1
```

This command enables the trigger output signal.

Reset Condition

On reset, the trigger output signal is disabled.

Query

```
OUTPut:TRIGger[:STATe]?
```

The query command enters a 1 or 0 into the output buffer indicating whether or not the trigger output signal is enabled/disabled.

- 1 is returned when the trigger output signal is enabled.
- 0 is returned when the trigger output signal is disabled.

Query Example

```
OUTPut:TRIG:STAT?
```

This command queries the status of the trigger output signal.

OUTPut:TTL[1]2:ACTive HIGH|LOW

This command controls whether a window limits fail drives the rear panel TTL Output HIGH or LOW. There are two TTL outputs:

- Output 1 (TTL1).
- Output 2 (TTL2).

Both can be connected to any of the CALC subsystems (that is the upper window upper/lower measurement or the lower window upper/lower measurement) using `OUTput:TTL:FEED <string>`.

Syntax

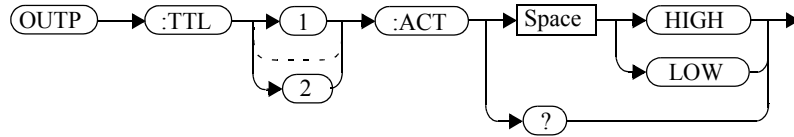

Example

```
OUTPut:TTL1:ACT HIGH
```

This command sets TTL output 1 HIGH whenever there is a limits fail in the upper window.

Reset Condition

On reset, a window limits fail will drive the TTL Output low.

Query

```
OUTPut:TTL[1] | 2:ACT?
```

The query command enters either HIGH or LOW into the output buffer indicating which TTL state is active for a window limit fail.

- HIGH is returned if the TTL output is active high for a window limit fail.
- LOW is returned if the TTL output is active low for a window limit fail.

Query Example

OUTP:TTL1:ACT?

This command queries whether the TTL Output for an upper window limit fail is active high or low.

OUTPut:TTL[1]|2:FEED <string>

This command controls which limit test drives a given TTL output. There are two TTL outputs:

- Output 1 (TTL1).
- Output 2 (TTL2).

Both can be connected to any of the CALC subsystems (that is the upper window upper/lower measurement or the lower window upper/lower measurement) using `OUTput:TTL:FEED <string>`.

Syntax

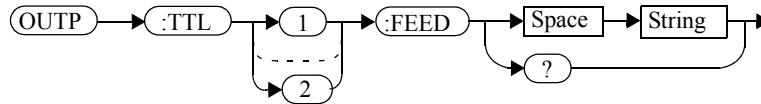

Parameters

TTL [1 2]	String	Description
1	"CALC1 2 3 4 : LIM: LOW"	TTL Output 1 asserted indicates a lower limit fail on the appropriate window/measurement.
	"CALC1 2 3 4 : LIM: UPP"	TTL Output 1 asserted indicates an upper limit fail on the appropriate window/measurement.
	"CALC1 2 3 4 : LIM: LOW, CALC1 2 3 4 : LIM: UPP" ¹	TTL Output 1 asserted indicates that either the lower or upper limit failed on the appropriate window/measurement.
2	"CALC1 2 3 4 : LIM: LOW"	TTL Output 2 asserted indicates a lower limit fail on the appropriate window/measurement.
	"CALC1 2 3 4 : LIM: UPP"	TTL Output 2 asserted indicates an upper limit fail on the appropriate window/measurement.
	"CALC1 2 3 4 : LIM: LOW, CALC1 2 3 4 : LIM: UPP" ¹	TTL Output 2 asserted indicates that either the lower or upper limit failed on the appropriate window/measurement.

TTL [1 2]	String	Description
Note: Either single or double quotes may be used. However, quotes are mandatory. All the above strings must be matched exactly - long forms and omission of the sub-op code are not permissible.		

1. The numeric value must be the same for both LOW and UP.

Example

OUTP:TTL1:FEED "CALC1:LIM:UPP" *This command asserts TTL Output 1 whenever there is an upper limit fail in the upper window/upper measurement.*

Reset Condition

On reset, the TTL output will represent an upper limit fail.

Query

OUTPut:TTL[1|2]:FEED?

The query command returns one of the strings shown in the table above, indicating whether the asserted state of the TTL Output represents a fail in the lower limit, upper limit or either limit for the selected window/measurement.

Query Example

OUTP:TTL1:FEED? *This command returns the string for TTL Output 1.*

OUTPut:TTL[1|2]:STATe <boolean>

This command is used to enable and disable the rear panel TTL Outputs.

There are two TTL outputs:

- Output 1 (TTL1).
- Output 2 (TTL2).

Both can be connected to any of the CALC subsystems (that is the upper window upper/lower measurement or the lower window upper/lower measurement) using `OUTput:TTL:FEED <string>`.

When enabled, the TTL Outputs can be used to determine when a predefined limit is exceeded.

Syntax

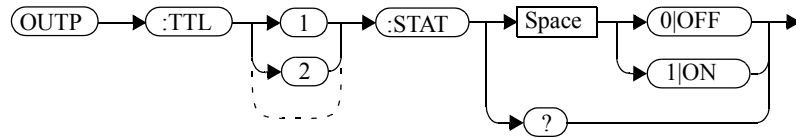

Example

```
OUTPut:TTL1:STAT 1
```

This command enables the rear panel upper window TTL output.

Reset Condition

On reset, the TTL outputs are disabled.

Query

```
OUTPut:TTL[1|2]:STATe?
```

The query command enters a 1 or 0 into the output buffer indicating whether or not the TTL output is enabled.

- 1 is returned when the TTL output is enabled.
- 0 is returned when the TTL output is disabled.

Query Example

OUTP:TTL1:STAT?

This command queries whether or not the upper window TTL output is enabled.

OUTput Subsystem
OUTPut:TTL[1|2]:STATE <boolean>

THIS PAGE HAS BEEN INTENTIONALLY LEFT BLANK.

9

———— **SENSe Subsystem**

[SENSe] Subsystem

The `SENSe` command subsystem directly affects device specific settings used to make measurements. The `SENSe` subsystem is optional since this is the primary function of the power meter. The high level command `CONFIgure` uses the `SENSe` commands to prepare the power meter for making measurements. At a lower level `SENSe` enables you to change the following parameters: `RANGe`, `FREQuency`, `LOSS`, `CFACator` | `GAIN1` (calibration factor), `GAIN2` (channel offset), `DCYCLe` (duty cycle) and `AVERAge`, without completely re-configuring the power meter.

The `SENSe` command subsystem also allows you to select the measurement speed, a sensor calibration table, and a frequency dependent offset table.

The numeric suffix of the `SENSe` program mnemonic in the `SENSe` commands refers to a channel, that is `SENSe1` and `SENSe2` represent channel A and channel B respectively.

Note

If you are using the single channel E4416A power meter the `SENSe2` commands are irrelevant and cause the error “Header suffix out of range.”

Keyword	Parameter Form	Notes	Page
[SENSe[1]] SENSe2			
:AVERage			
:COUNT	<numeric_value>		page 9-6
:AUTO	<boolean>		page 9-8
:SDETECT	<boolean>	[non-SCPI]	page 9-11
[:STATe]	<boolean>		page 9-13
AVERage2			
:COUNT	<numeric_value>		page 9-15
[:STATe]	<boolean>		page 9-17
:BANDwidth BWIDth			
:VIDeo	<character_data>		page 9-18
:CORRection			
:CFACtor GAIN[1]		[non-SCPI]	
[:INPut]			
[:MAGNitude]	<numeric_value>		page 9-21
:CSET[1] CSET2			
[:SElect]	<string>		page 9-24
:STATe	<boolean>		page 9-26
:DCYClE GAIN3		[non-SCPI]	
[:INPut]			
[:MAGNitude]	<numeric_value>		page 9-29
:STATe	<boolean>		page 9-32
:FDOFFset GAIN4			
[:INPut]			
[:MAGNitude] ?		[query only]	page 9-34
:GAIN2			
:STATe	<boolean>		page 9-36
[:INPut]			
[:MAGNitude]	<numeric_value>		page 9-38
:DETEctor			
:FUNction	<character_data>		page 9-40
:FREQuency			
[:CW :FIXed]	<numeric_value>		page 9-42
:MRATe	<character_data>		page 9-44
:POWer			
:AC			
:RANGe	<numeric_value>	[non-SCPI]	page 9-46
:AUTO	<boolean>		page 9-47
:SPeEd	<numeric_value>	[non-SCPI]	page 9-49
:SWEep[1] 2 3 4			
:OFFSet			
:TIME	<numeric_value>		page 9-52
:TIME	<numeric_value>		page 9-54
:TRACe			
:LIMit			
:LOWer	<numeric_value>		page 9-57
:UPPer	<numeric_value>		page 9-59
:OFFSet			

SENSe Subsystem
[SENSe] Subsystem

Keyword	Parameter Form	Notes	Page
:TIME	<numeric_value>		page 9-61
:TIME	<numeric_value>		page 9-63
:UNIT	<character_data>		page 9-65
:V2P	ATYPE DTYPe	[non-SCPI]	page 9-66

[SENSe[1]]|SENSe2:AVERAge Commands

These commands control averaging which is used to improve measurement accuracy. They combine successive measurements to produce a new composite result.

The following commands are detailed in this section:

```
[SENSe[1]] | SENSe2:AVERAge:COUNT <numeric_value>  
[SENSe[1]] | SENSe2:AVERAge:COUNT:AUTO <boolean>  
[SENSe[1]] | SENSe2:AVERAge:SDETect <boolean>  
[SENSe[1]] | SENSe2:AVERAge[:STATe] <boolean>
```

[SENSe[1]]|SENSe2:AVERAge:COUNT <numeric_value>

This command is used to enter a value for the filter length. If [SENSe[1]]|SENSe2:AVERAge:COUNT:AUTO is set to ON then entering a value for the filter length automatically sets it to OFF. Increasing the value of filter length increases measurement accuracy but also increases the time taken to make a power measurement.

Entering a value using this command automatically turns the [SENSe[1]]|SENSe2:AVERAge:STATe command to ON.

Note For most applications, automatic filter length selection ([SENSe[1]]|SENSe2:AVERAge:COUNT:AUTO ON) is the best mode of operation. However, manual filter length selection ([SENSe[1]]|SENSe2:AVERAge:COUNT <numeric_value>) is useful in applications requiring either high resolution or fast settling times.

Syntax

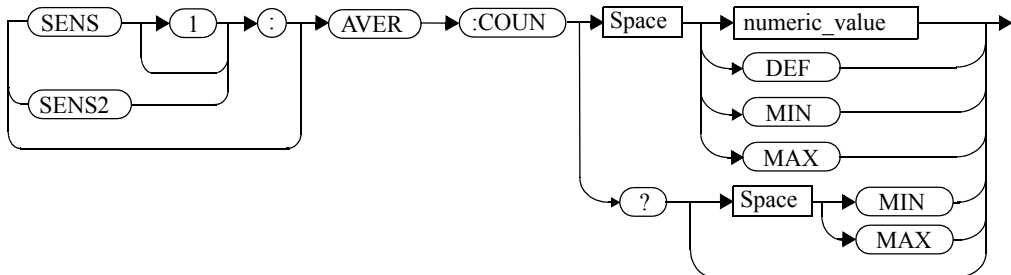

Parameters

Item	Description/Default	Range of Values
numeric_value	A numeric value defining the filter length. <ul style="list-style-type: none"> • DEF: the default value is 4. • MIN: 1. • MAX: 1024. 	1 to 1024 DEF MIN MAX

Example

AVER:COUN 400

This command enters a filter length of 400 for channel A.

Reset Condition

On reset, the filter length is set to 4.

Query

AVERAge:COUNT? [MIN|MAX]

The query returns the current setting of the filter length or the values associated with MIN and MAX. The format of the response is <NR1>.

Query Example

AVER:COUN?

This command queries the filter length for channel A.

Error Messages

If a filter length value is entered using [SENSe[1]]|SENSe2:AVERAge:COUNT while [SENSe[1]]|SENSe2:SPEEd is set to 200, the error -221, “Settings Conflict” occurs. However, the filter length value is set but the [SENSe[1]]|SENSe2:AVERAge:STATe command is not automatically set ON.

[SENSe[1]]|SENSe2:AVERAge:COUNT:AUTO <boolean>

This command enables and disables automatic averaging. ONCE has no affect on the power meter.

When the auto filter mode is enabled, the power meter automatically sets the number of readings averaged together to satisfy the averaging requirements for most power measurements. The number of readings averaged together depends on the resolution and the power level in which the power meter is currently operating. Figure 0-13 lists the number of readings averaged for each range and resolution when the power meter is in auto filter mode.

Setting this command to ON automatically sets the
[SENSe[1]]|SENSe2:AVERAge:STATe command to ON.

Figure 0-13: Averaged Readings

Power Sensor Dynamic Range	Maximum Sensor Power	Resolution Setting				Number of Averages
		1	2	3	4	
		1	1	1	8	
10 dB		1	1	1	16	
10 dB		1	1	2	32	
10 dB		1	1	16	256	
10 dB		1	8	128	128	
	Minimum Sensor Power					

If **[SENSe[1]]|SENSe2:AVERAge:COUNT:AUTO** is set to OFF, the filter length is set by the **[SENSe[1]]|SENSe2:AVERAge:COUNT** command. Using the **[SENSe[1]]|SENSe2:AVERAge:COUNT** command automatically disables automatic averaging.

Auto averaging is enabled by the **MEASure:POWer:AC?** and **CONFigure:POWer:AC?** commands.

Note For most applications, automatic filter length selection ([SENSe[1]]|SENSe2:AVERage:COUNT:AUTO ON) is the best mode of operation. However, manual filter length selection ([SENSe[1]]|SENSe2:AVERage:COUNT <numeric_value>) is useful in applications requiring either high resolution or fast settling times.

Syntax

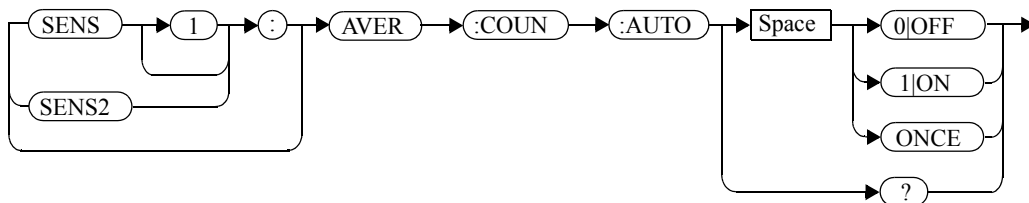

Example

AVER:COUNT:AUTO OFF

This command disables automatic filter length selection for channel A.

Reset Condition

On reset, automatic averaging is enabled.

Query

[SENSe[1]]|SENSe2:AVERage:COUNT:AUTO?

The query enters a 1 or 0 into the output buffer indicating whether automatic filter length is enabled or disabled.

- 1 is returned when automatic filter length is enabled.
- 0 is returned when automatic filter length is disabled.

Query Example

AVER:COUNT:AUTO?

This command queries whether automatic filter length selection is on or off for channel A.

Error Messages

If [SENSe[1]] | SENSe2:AVERage:COUNT:AUTO is set to ON while [SENSe[1]] | SENSe2:SPEEd is set to 200, the error -221, “Settings Conflict” occurs. However, automatic averaging is enabled but the [SENSe[1]] | SENSe2:AVERage:STATe command is not automatically set ON.

[SENSe[1]]|SENSe2:AVERage:SDETECT <boolean>

This command enables and disables step detection. In AUTO filter mode, the average of the last four values entered into the filter is compared to the average of the entire filter. If the difference between the two averages is greater than 12.5%, the digital filter is cleared. The filter then starts storing new measurements. This feature is known as step detection and shortens the settling time of the filter when the input power changes substantially.

Note Step detection is automatically disabled under the following circumstances:

- TRIG:DEL:AUTO is ON and the trigger mode is set to free run. or,
- Auto-averaging is disabled.

Under the above circumstances the value of SENS:AVER:SDET is ignored. Note also that SENS:AVER:SDET is not set by the instrument (that is, SENS:AVER:SDET will retain its current setting which may indicate that step detection is ON).

Syntax

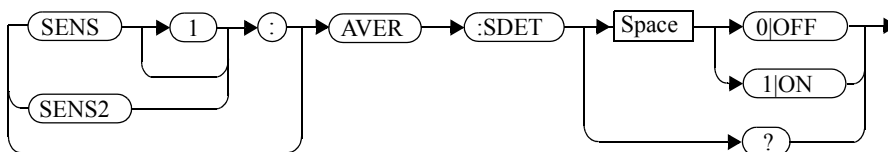

Example

SENS:AVER:SDET OFF *This command disables step detection.*

Reset Condition

On reset, step detection is enabled.

Query

[SENSe[1]]|SENSe2:AVERage:SDETECT?

The query enters a 1 or 0 into the output buffer indicating the status of step detection.

- 1 is returned when step detection is enabled.
- 0 is returned when step detection is disabled.

Query Example

SENS : AVER : SDET ?

This command queries whether step detection is on or off.

[SENSe[1]]|SENSe2:AVERAge[:STATe] <boolean>

This command is used to enable and disable averaging.

Syntax

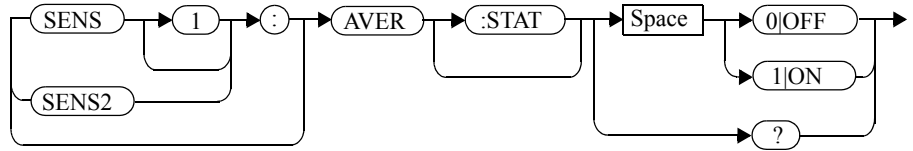

Example

AVER 1

This command enables averaging on channel A.

Reset Condition

On reset, averaging is enabled.

Query

[SENSe[1]]|SENSe2:AVERAge[:STATe]?

The query enters a 1 or 0 into the output buffer indicating the status of averaging.

- 1 is returned when averaging is enabled.
- 0 is returned when averaging is disabled.

Query Example

SENSe2:AVER?

This command queries whether averaging is on or off for channel B.

Error Messages

If [SENSe[1]]|SENSe2:AVERAge:STATe is set to ON while [SENSe[1]]|SENSe2:SPEEd is set to 200, the error -221, “Settings Conflict” occurs.

[SENSe[1]]|SENSe2:AVERAge2 Commands

These commands control video averaging, which is used to improve measurement accuracy, for the E-Series E9320 Power Sensor. They combine successive measurements to produce a new composite result.

Note

If the commands in this section are used when a non E9320 sensor is connected, the error -241, “Hardware missing” occurs.

If the commands in this section are used when an E9320 sensor is connected and set to AVERAge mode rather than NORMAl mode, the error -221, “Settings Conflict” occurs.

The following commands are detailed in this section:

```
[SENSe[1]] |SENSe2:AVERAge2:COUNT <numeric_value>  
[SENSe[1]] |SENSe2:AVERAge2[:STATE] <boolean>
```

[SENSe[1]]|SENSe2:AVERage2:COUNT <numeric_value>

This command is used to enter the video filter length for the E9320 sensor.

Syntax

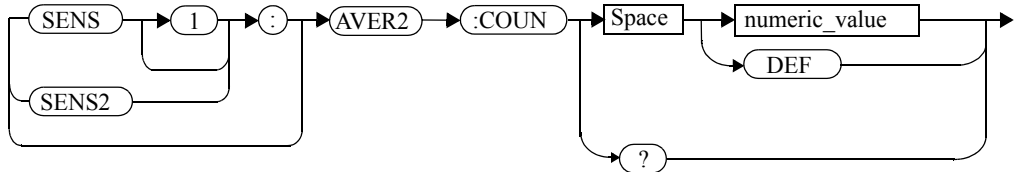

Parameters

Item	Description/Default	Range of Values
numeric_value	A numeric value defining the filter length. <ul style="list-style-type: none"> DEF: the default value is 4. 	1 to 256 DEF

Example

AVER2:COUNT 200

This command enters a video filter length of 200 for channel A.

Reset Condition

On reset, the filter length is set to 4.

Query

AVERage2:COUNT?

The query returns the current setting of the video filter length. The format of the response is <NR1>.

Query Example

AVER2:COUNT?

This command queries the video filter length for channel A.

SENSe Subsystem
[SENSe[1]]|SENSe2:AVERAge2:COUNT <numeric_value>

Error Messages

- If the command is used when a non E9320 sensor is connected, the error -241, “Hardware missing” occurs.
- If the command is used when an E9320 sensor is connected and set to AVERAge mode rather than NORMa1 mode, the error -221, “Settings Conflict” occurs.

SENSe[1]]|SENSe2:AVERage2[:STATe] <boolean>

This command is used to enable and disable video averaging for the E9320 sensor.

Syntax

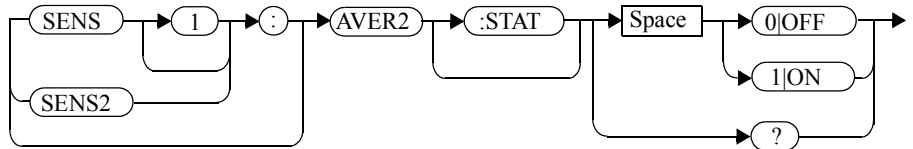

Example

AVER2 1

This command enables video averaging on channel A.

Reset Condition

On reset, averaging is enabled.

Query

[SENSe [1]] | SENSe2 : AVERage2 [: STATe] ?

The query enters a 1 or 0 into the output buffer indicating the status of averaging.

- 1 is returned when averaging is enabled.
- 0 is returned when averaging is disabled.

Query Example

SENS2 : AVER2 ?

This command queries whether averaging is on or off for channel B.

Error Messages

- If the command is used when a non E9320 sensor is connected, the error -241, “Hardware missing” occurs.
- If the command is used when an E9320 sensor is connected and set to AVERage mode rather than NORMa1 mode, the error -221, “Settings Conflict” occurs.

[SENSe[1]]|SENSe2:BANDwidth|BWIDth:VIDeo <character_data>

This command sets the sensor bandwidth.

Syntax

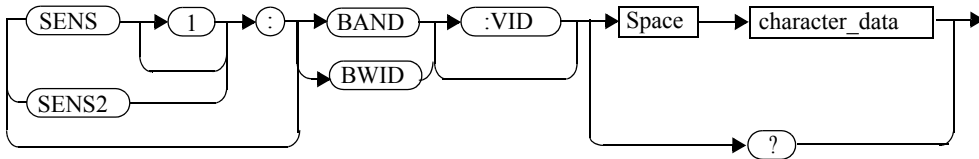

Parameters

Item	Description/Default	Range of Values
character_data	Defines the sensor band width.	HIGH MEDIum LOW OFF

Values for HIGH, MEDIUM, LOW and OFF are sensor dependant as shown in the following table:

Sensor	Video Bandwidth Settings			
	LOW	MEDIum	HIGH	OFF
E9321A E9325A	30 kHz	100 kHz	300 kHz	300 kHz ¹
E9322A E9326A	100 kHz	300 kHz	1.5 MHz	1.5 MHz ¹
E9323A E9327A	300 kHz	1.5 MHz	5 MHz	5 MHz ¹

1. At 3.0 dB roll off point.

Example

SENSe1:BAND:VID HIGH

This command sets sensor bandwidth to high for channel A.

Reset Condition

On reset, sensor bandwidth is set to MEDium.

Query

[SENSe[1]]|SENSe2:BANDwidth|BWIDth:VIDeo?

The query returns the current sensor bandwidth setting.

Query Example

SENS2:BAND:VID?

This command queries the current sensor bandwidth setting for channel B.

Error Messages

- If the command is used when a non E9320 sensor is connected, the error -241, “Hardware missing” occurs.
- If the command is used when an E9320 sensor is connected and set to AVERAge mode rather than NORMa1 mode, the error -221, “Settings Conflict” occurs.

[SENSe[1]]|SENSe2:CORRection Commands

These commands provide for known external losses or gains. They are used to enter duty cycle values, calibration factors and other external gains and losses.

The following commands are detailed in this section:

```
[SENSe[1]]|SENSe2:CORRection:CFACTOR|GAIN[1][:INPut]
[:MAGNitude] <numeric_value>
[SENSe[1]]|SENSe2:CORRection:CSET[1]|CSET2
[:SElect] <string>
[SENSe[1]]|SENSe2:CORRection:CSET[1]|CSET2:STATe <boolean>
[SENSe[1]]|SENSe2:CORRection:DCYCLe|GAIN3[:INPut]
[:MAGNitude] <numeric_value>
[SENSe[1]]|SENSe2:CORRection:DCYCLe|GAIN3:STATe <boolean>
[SENSe[1]]|SENSe2:CORRection:FDOFfset|GAIN4[:INPut]
[:MAGNitude]?
[SENSe[1]]|SENSe2:CORRection:LOSS2[:INPut][:MAGNitude]
<numeric_value>
[SENSe[1]]|SENSe2:CORRection:LOSS2:STATe <boolean>
```

SENSe[1]]|SENSe2:CORRection:CFACtor|GAIN[1][:INPut][:MAGNitude] <numeric_value>

This command is used to enter a gain correction value for the calibration factor. The power meter corrects every measurement by this factor to compensate for the gain.

Either CFACtor and GAIN1 can be used in the command—both have an identical result. Using GAIN1 complies with the SCPI standard whereas CFACtor does not but may make your program easier to understand.

Syntax

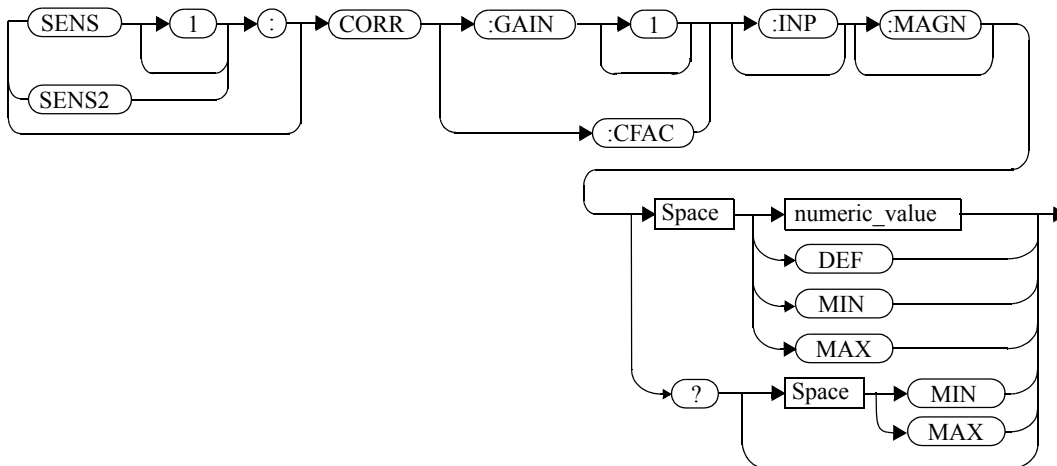

Parameters

Item	Description/Default	Range of Values
numeric_value (for CFACtor and GAIN1)	A numeric value. <ul style="list-style-type: none"> • DEF: the default value is 100%. • MIN: 1%. • MAX: 150%. 	1 to 150 PCT ¹ DEF MIN MAX

1. For example, a gain of 60% corresponds to a multiplier of 0.6 and a gain of 150% corresponds to a multiplier of 1.5.

Example

SENS2:CORR:GAIN1

This command sets a gain correction of 100% for channel B.

Reset Condition

On reset, CFACTOR|GAIN1 is set to 100%.

Query

[SENSe[1]]|SENSe2:CORRection:CFACTOR|GAIN[1][:INPut][:MAGNitude]? [MIN|MAX]

The query returns the current gain correction setting or the values associated with MIN and MAX.

Query Example

CORR:GAIN1?

This command queries the current calibration factor setting for channel A.

Error Messages

The SENSe[1]]|SENSe2:CORRection:CFACTOR|GAIN1 command can be used for the 8480 Series power sensors and N8480 Series power sensors with Option CFT when no sensor calibration table has been set up. If a sensor calibration table is selected the error -221, “Settings Conflict” occurs.

[SENSe[1]]|SENSe2:CORRection:CSET[1]|CSET2 Commands

These commands are used to select the active sensor calibration table (using CSET1) and the active frequency dependent offset table (using CSET2).

Note

If any of the CSET1 commands are used when an E-Series power sensor or N8480 Series power sensor (excluding Option CFT) is connected, the error -241, “Hardware missing” occurs.

The following commands are detailed in this section:

```
[SENSe[1]] | SENSe2:CORRection:CSET[1] | CSET2  
[:SElect] <string>  
[SENSe[1]] | SENSe2:CORRection:CSET[1] | CSET2:STATe  
<boolean>
```

[SENSe[1]]|SENSe2:CORRection:CSET[1]|CSET2[:SELEct] <string>

This command enters the name of the sensor calibration table or frequency dependent offset table which is to be used. The CSET1 command selects the sensor calibration table and the CSET2 command selects the frequency dependent offset table. The calibration factor is interpolated from the table using the setting for [SENSe[1]] | SENSe2:FREQuency.

Note

If [SENSe[1]] | SENSe2:CORRection:CSET[1] | CSET2:STATe is set to OFF, the selected sensor calibration table or frequency offset table is not being used.

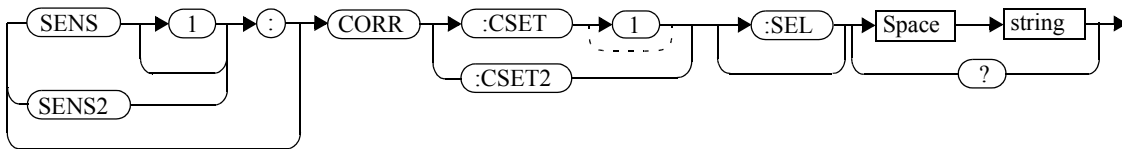
Syntax**Parameters**

Item	Description/Default	Range of Values
string	String data representing a sensor calibration table, or frequency dependent offset table name.	Any existing table name (Existing table names can be listed using MEMory:CATalog:TABLE?).

Example

```
CORR:CSET1 "PW1"
```

This command enters the name of the sensor calibration table which is to be used on channel A.

Reset Condition

On reset the selected table is not affected.

Query

```
[SENSe[1]]|SENSe2:CORRection:CSET[1]|CSET2:[SElect]?
```

The name of the selected table is returned as a quoted string. If no table is selected an empty string is returned.

Query Example

```
CORR:CSET1?
```

This command queries the sensor calibration table currently used for channel A.

Error Messages

- If <string> is not valid, error -224, “Illegal parameter value” occurs.
- If a table called <string> does not exist, error -256, “File name not found” occurs.
- When a sensor calibration table is selected, the power meter verifies that the number of calibration points defined is one more than the number of frequency points defined. When a frequency dependent offset table is selected, the power meter verifies that the number of offset points defined is equal to the number of frequency points defined. If this is not the case, error -226, “Lists not the same length” occurs.
- If the CSET1 command is used when an E-Series power sensor or N8480 Series power sensor (excluding Option CFT) is connected the error -241, “Hardware missing” occurs.

[SENSe[1]]|SENSe2:CORRection:CSET[1]|CSET2:STATe <boolean>

This command is used to enable and disable the use of the currently active sensor calibration table (CSET1) or frequency dependent offset table (CSET2). When a table has been selected and enabled, the calibration factors/offsets stored in it can be used by specifying the required frequency using the [SENSe[1]]|SENSe2:FREQuency command.

When the CSET1 command is set to ON, the reference calibration factor is taken from the sensor calibration table and is used during calibration.

The CSET1 command is only applicable for 8480 Series power sensors and N8480 Series power sensors with Option CFT.

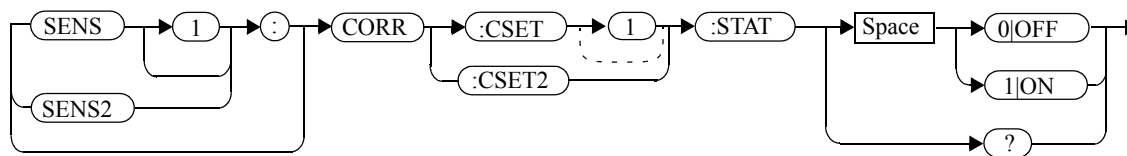
Syntax**Example**

```
CORR:CSET1:STAT 1
```

This command enables the use of the currently active sensor calibration table for channel A.

Reset Condition

On reset, the sensor calibration table and frequency dependent offset table are not affected.

Query

```
[SENSe[1]]|SENSe2:CORRection:CSET[1]|CSET2:STATe?
```

The query returns a 1 or 0 into the output buffer indicating whether a table is enabled or disabled.

- 1 is returned when the table is enabled.
- 0 is returned when the table is disabled.

Query Example

SENS2:CORR:CSET1:STAT?

This command queries whether there is currently an active sensor calibration table for channel B.

Error Messages

If you attempt to set this command to ON and no table has been selected using [SENSe[1]]|SENSe2:CORRection:CSET[1]|CSET2:[SELEct] then error -221, “Settings conflict” occurs and [SENSe[1]]|SENSe2:CORRection:CSET[1]|CSET2:STATe remains OFF.

[SENSe[1]]|SENSe2:CORRection:DCYCLe|GAIN3 Commands

These commands control the pulse power measurement feature of the power meter.

The following commands are detailed in this section:

```
[SENSe[1]]|SENSe2:CORRection:DCYCLe|GAIN3[:INPut]
[:MAGNitude] <numeric_value>
[SENSe[1]]|SENSe2:CORRection:DCYCLe|GAIN3:STATe <boolean>
```

Note

You can use either DCYCLe or GAIN3 in these commands, both do the same. Using GAIN3 complies with the SCPI standard whereas DCYCLe does not, but may make your program more understandable.

[SENSe[1]]|SENSe2:CORRection:DCYClE|GAIN3[:INPut][:MAGNitude] <numeric_value>

This command is used to set the duty cycle for the pulse power measurement feature of the power meter. Pulse power measurements average out any aberrations in the pulse such as overshoot or ringing. The result returned for a pulse power measurement is a mathematical representation of the pulse power rather than an actual measurement. The power meter measures the average power in the pulsed input signal and then divides the result by the duty cycle value to obtain a pulse power reading.

Entering a value using this command automatically turns the [SENSe[1]]|SENSe2:CORRection:DCYClE|GAIN3:STATe command to ON.

Note

Pulse measurements are not recommended using E-Series power sensors at power levels above -20 dBm.

Pulse power averages out any aberrations in the pulse such as overshooting or ringing. For this reason it is called pulse power and not peak power or peak pulse power.

In order to ensure accurate pulse power readings, the input signal must be pulsed with a rectangular pulse. Other pulse shapes (such as triangle, chirp or Gaussian) will cause incorrect results.

The pulse power on/off ratio must be much greater than the duty cycle ratio.

Syntax

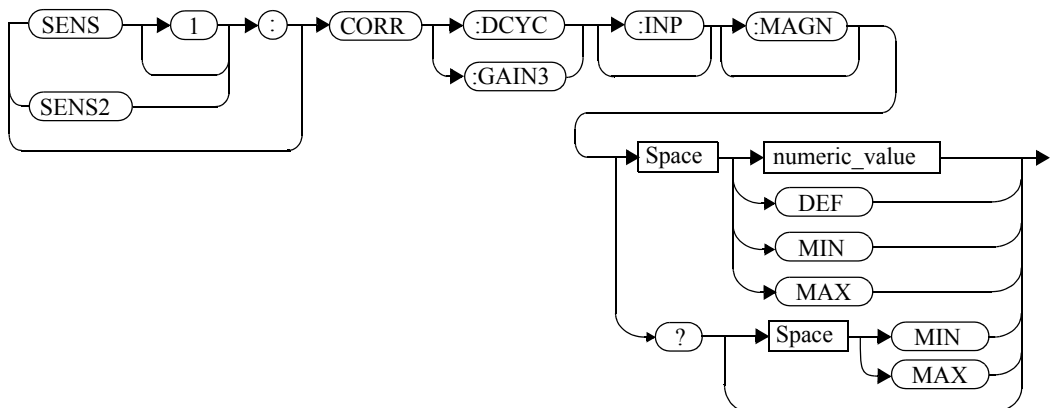

Parameters

Item	Description/Default	Range of Values
numeric_value	<p>A numeric value for the duty cycle.</p> <ul style="list-style-type: none"> DEF: the default value is 1%. MIN: 0.001%. MAX: 99.999%. <p>The units are PCT, and are optional.</p>	<p>0.001 to 99.999 PCT</p> <p>DEF MIN MAX</p>

Example

CORR:DCYC 90PCT

This command sets a duty cycle of 90% for channel A.

Reset Condition

On reset, the duty cycle is set to 1% (DEF).

Query

[SENSe[1]]|SENSe2:CORRection:DCYClE|GAIN3[:INPut][:MAGNitude]? [MIN|MAX]

The query returns the current setting of the duty cycle or the values associated with MIN and MAX.

Query Example

CORR:GAIN3?

This command queries the current setting of the duty cycle for channel A.

Error Messages

- If a duty cycle value is entered using [SENSe[1]]|SENSe2:CORRection:DCYClE|GAIN3 while [SENSe[1]]|SENSe2:SPEEd is set to 200, the error -221, “Settings Conflict” occurs. However, the duty cycle value is set but the [SENSe[1]]|SENSe2:CORRection:DCYClE|GAIN3:STATe command is not automatically set ON.

- If this command is used when an E-Series power sensor is connected, the error -310, “System error;Dty Cyc may impair accuracy with ECP sensor” occurs. If you are using the E4417A the error message specifies the channel.

[SENSe[1]]|SENSe2:CORRection:DCYClE|GAIN3:STATe <boolean>

This command is used to enable and disable the pulse power measurement feature.

The [SENSe[1]]|SENSe2:CORRection:DCYClE|GAIN3 command should be used to enter the duty cycle of the signal you want to measure.

Syntax

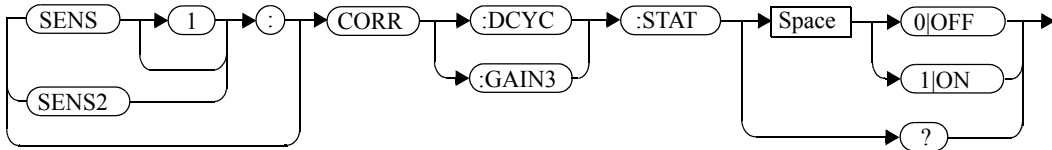

Example

```
CORR:DCYC:STAT 1
```

This command enables the pulse measurement feature on channel A.

Reset Condition

On reset, the pulse power measurement feature is disabled.

Query

```
[SENSe[1]]|SENSe2:CORRection:DCYClE|GAIN3:STATe?
```

The query enters a 1 or 0 into the output buffer indicating the status of the pulse power measurement feature.

- 1 is returned when the pulse power measurement feature is enabled.
- 0 is returned when the pulse power measurement feature is disabled.

Query Example

```
CORR:GAIN3:STAT?
```

This command queries whether the pulse measurement feature is on or off.

Error Messages

- If [SENSe[1]]|SENSe2:CORRection:DCYClE:STATus is set to ON while [SENSe[1]]|SENSe2:SPEEd is set to 200, the error -221, “Settings Conflict” occurs.
- If this command is used when an E4410 E-Series powers sensor is connected, the error -310, “System error;Dty Cyc may impair accuracy with ECP sensor” occurs. If you are using the E4417A the error message specifies the channel.

[SENSe[1]][SENSe2:CORRection:FDOFset|GAIN4[:INPut][:MAGNitude]?

This command is used to return the frequency dependent offset currently being applied.

Syntax

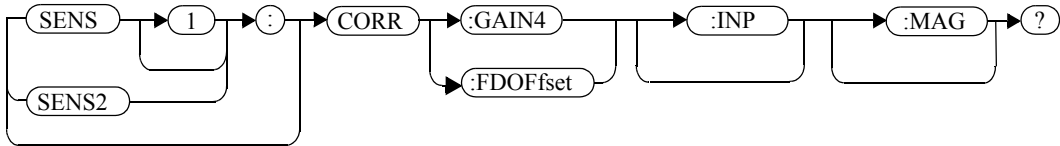

Example

CORR :GAIN4 ?

This command queries the current frequency dependent offset being applied to channel A.

Reset Condition

On reset, the frequency dependent offset is not affected.

[SENSe[1]]|SENSe2:CORRection:GAIN2 Commands

These commands provide a simple correction to a measurement for an external gain/loss.

The following commands are detailed in this section:

```
[SENSe[1]]|SENSe2:CORRection:GAIN2:STATe <boolean>  
[SENSe[1]]|SENSe2:CORRection:GAIN2[:INPut][:MAGNitude]  
  <numeric_value>
```

[SENSe[1]]|SENSe2:CORRection:GAIN2:STATe <boolean>

This command is used to enable/disable a channel offset for the power meter setup. The [SENSe[1]]|SENSe2:CORRection:GAIN2[:INPut][:MAGNitude] command is used to enter the loss/gain value.

Syntax

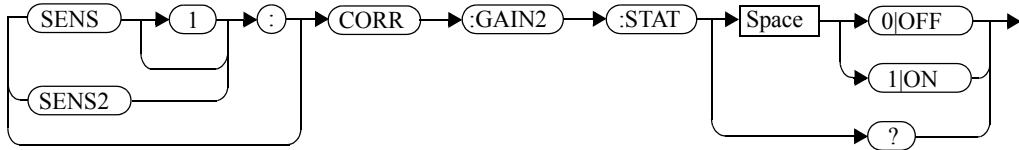

Example

```
CORR:GAIN2:STAT ON
```

This command enables a channel offset on channel A.

Reset Condition

On reset, channel offsets are disabled.

Query

```
[SENSe[1]]|SENSe2:CORRection:GAIN2:STATe?
```

The query enters 1 or 0 into the output buffer indicating the status of the channel offsets.

- 1 is returned if a channel offset is enabled.
- 0 is returned if a channel offset is disabled.

Query Example

```
CORR:GAIN2:STAT?
```

This command queries whether or not there is a channel offset applied to channel A.

Error Messages

If [SENSe[1]]|SENSe2:CORRection:GAIN2:STATe is set to ON while [SENSe[1]]|SENSe2:SPEEd is set to 200, the error -221, “Settings Conflict” occurs.

[SENSe[1]]|SENSe2:CORRection:GAIN2[:INPut][:MAGNitude] <numeric_value>

This command is used to enter a channel offset value for the power meter setup, for example cable loss. The power meter then corrects every measurement by this factor to compensate for the gain/loss.

Entering a value for GAIN2 using this command automatically turns the [SENSe[1]]|SENSe2:CORRection:GAIN2:STATe command to ON.

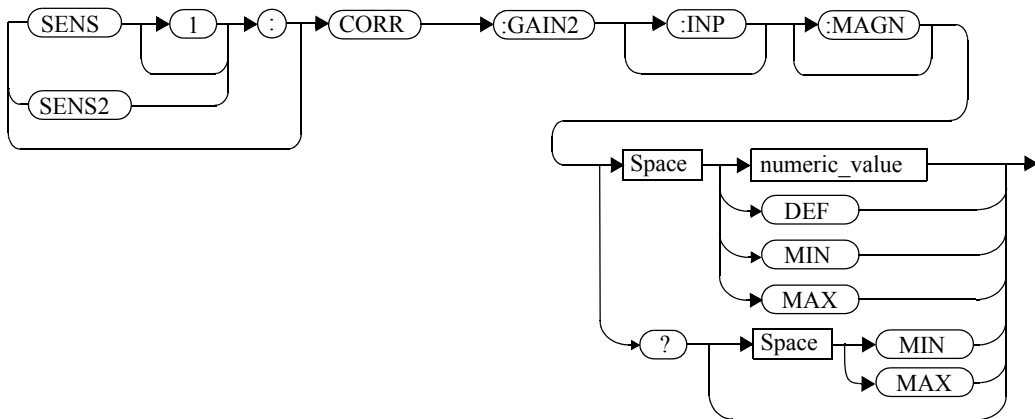
Syntax

Parameters

Item	Description/Default	Range of Values
numeric_value	A numeric value: <ul style="list-style-type: none"> • DEF: the default is 0.00 dB. • MIN: -100 dB. • MAX: +100 dB. 	-100 to +100 dB DEF MIN MAX

Example

```
CORR:GAIN2 50
```

This command sets a channel offset of 50 dB for channel A.

[SENSe[1]]|SENSe2:CORRection:GAIN2[:INPut][:MAGNitude] <numeric_value>

Reset Condition

On reset, GAIN2 is set to 0.00 dB.

Query

[SENSe[1]]|SENSe2:CORRection:GAIN2[:INPut][:MAGNitude]? [MIN|MAX]

The query returns the current setting of the channel offset or the values associated with MIN and MAX.

Query Example

CORR:GAIN2?

This command queries the current setting of the channel offset on channel A.

Error Messages

- If a loss/gain correction value is entered using [SENSe[1]]|SENSe2:CORRection:GAIN2[:INPut][:MAGNitude] while [SENSe[1]]|SENSe2:SPEEd is set to 200, the error -221, “Settings Conflict” occurs. However, the correction value is set but the [SENSe[1]]|SENSe2:CORRection:GAIN2:STATE command is not automatically set ON.
- The [SENSe[1]]|SENSe2:CORRection:GAIN2[:INPut][:MAGNitude] command can be used for the 8480 Series power sensors and N8480 Series power sensors with Option CFT when no sensor calibration table has been set up. If a sensor calibration table is selected the error -221, “Settings Conflict” occurs.

[SENSe[1]][SENSe2:DETEctor:FUNCTion <character_data>

This command sets the measurement mode for the E9320 sensor.

Syntax

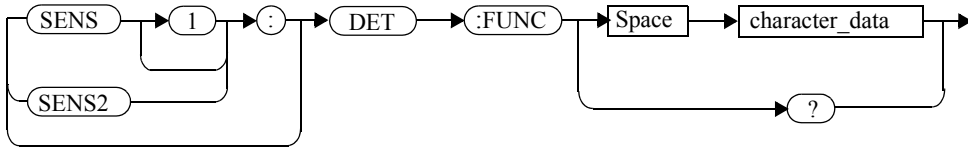

Parameters

Item	Description/Default	Range of Values
character_data	Defines the measurement mode: <ul style="list-style-type: none"> AVERAge: sets the E9320 sensor to average only mode. NORMAl: sets the E9320 sensor to normal mode. 	AVERAge ¹ NORMAl ²

- When measurement mode is set to average:
 - If TRIG : SOUR is set to INT1, INT2 or EXT, it is set automatically to IMM.
 - INIT : CONT is set automatically to ON.
 - SENS : AVER2 : STAT is set automatically to OFF.
 - CALC : FEED is set automatically to "POW : AVG" for all CALC blocks using the specified channel in their CALC : MATH : EXPR.
- When measurement mode is set to NORMAl:
 - SENS : CORR : DCYC : STAT is set automatically to OFF.

Example

SENS1 : DET : FUNC NORM

This command sets the sensor to normal mode for channel A.

Reset Condition

On reset, the mode is set to NORMAl.

Query

```
[SENSe[1]]|SENSe2:DETEctor:FUNCTion?
```

The query returns the current sensor mode setting.

Query Example

```
SENS:DET:FUNC?
```

This command queries the current sensor mode setting for channel A.

Error Messages

- If the command is used when a non E9320 sensor is connected, the error -241, “Hardware missing” occurs.
- If the command is used when an E9320 sensor is connected and set to AVERAge mode rather than NORMa1 mode, the error -221, “Settings Conflict” occurs.

[SENSe[1]]|SENSe2:FREQUENCY[:CW|:FIXed] <numeric_value>

This command is used to enter a frequency. If the frequency does not correspond directly to a frequency in the sensor calibration table, the power meter calculates the calibration factor using linear interpolation. For 8480 Series power sensors and N8480 Series power sensors with Option CFT, the power meter uses linear interpolation to calculate the calibration factor for the frequency entered if [SENSe[1]] | SENSe2:CORREction:CSET:STATe is ON. For E-Series and N8480 Series power sensors (excluding Option CFT), the calibration factor is calculated using the sensor’s calibration factor data held in its EEPROM.

Syntax

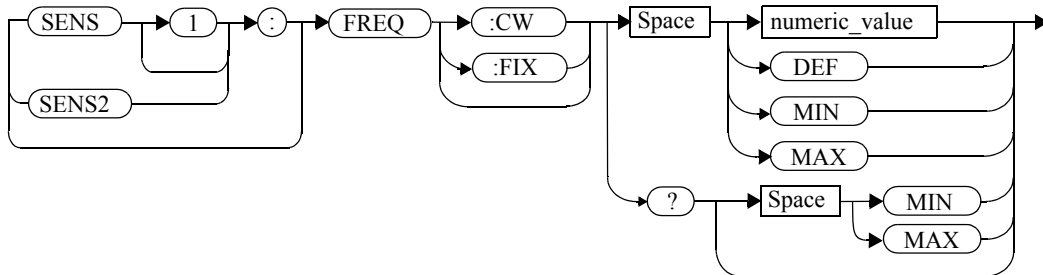

Parameters

Item	Description/Default	Range of Values
numeric_value	A numeric value for the frequency: <ul style="list-style-type: none"> • DEF: the default value is 50 MHz. • MIN: 1 kHz. • MAX: 999.999 GHz. The default units are Hz.	1 kHz to 999.999 GHz ¹ DEF MIN MAX

1. The following measurement units can be used:

- Hz
- kHz (10³)
- MHz (10⁶)
- GHz (10⁹)

Example

FREQ 500kHz

This command enters a channel A frequency of 500 kHz.

Reset Condition

On reset, the frequency is set to 50 MHz (DEF).

Query

[SENSe[1]]|SENSe2:FREQUENCY[:CW]:FIXed]? [MIN|MAX]

The query returns the current frequency setting or the values associated with MIN and MAX. The units in which the results are returned are Hz.

Query Example

SENS2:FREQ?

This command queries the channel B frequency setting.

[SENSe[1]]|SENSe2:MRATe <character_data>

This command sets the measurement speed on the selected channel.

When a channel is set to FAST, the following couplings occur:

Command	Status
[SENSe[1]] SENSe2:AVERAge:STATe	OFF ¹
[SENSe[1]] SENSe2:CORRection:DCYClE:STATe	OFF ¹
[SENSe[1]] SENSe2:CORRection:GAIN2:STATe	OFF ¹
CALCulate[1 2 3 4]:GAIN:STATe	OFF ²
CALCulate[1 2 3 4]:RELative:STATe	OFF ²
CALCulate1 3:MATH:EXPRession	"(SENSe1)"
CALCulate2 4:MATH:EXPRession	"(SENSe2)" ³

1. This change only occurs on the channel specified in the SENSe:MRATe command. When the specified channel is changed from FAST to NORMAl or DOUBLe, the settings that were in place when FAST was entered are restored.

2. This change occurs when either channel is set to FAST. When both channels are changed from FAST to NORMAl or DOUBLe, the settings that were in place when FAST was entered are restored.

3. Applicable to the E4417A dual channel power meter only.

Note FAST mode cannot be used over RS232 or RS422 serial interfaces.

Syntax

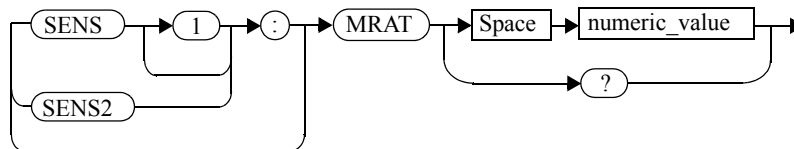

Parameters

Item	Description/Default	Range of Values
character_data	<p>A numeric value for the measurement speed:</p> <ul style="list-style-type: none"> • NORMAl: 20 readings/second. • DOUBle: 40 readings/second. • FAST: up to 1000 readings/second. <p>The default is NORMAl.</p>	<p>NORMAl¹ DOUBle¹ FAST²</p>

1. When a channel is set to NORMAl or DOUBle, TRIG:COUNT is set automatically to 1.
2. FAST mode cannot be used over RS232 or RS422 serial interfaces.

Example

```
MRAT DOUBle
```

This command sets the channel A speed to 40 readings/second.

Reset Condition

On reset, the speed is set to NORMAl.

Query

```
[SENSe[1]]|SENSe2:MRAT?
```

The query returns the current speed setting, either NORMAl, DOUBle or FAST.

Query Example

```
MRAT?
```

This command queries the current speed setting for channel A.

Error Messages

- If <character_data> is not set to NORMAl, DOUBle or FAST, error -224 “Illegal parameter value” occurs.
- If an E-Series power sensor is not connected and <character_data> is set to FAST, error -241 “Hardware missing” occurs.
- If TRIG:SOUR is set to EXTERNAL or INTERNAL [[1] | 2], error -221 “Settings Conflict” occurs.

[SENSe[1]]|SENSe2:POWer:AC:RANGe <numeric_value>

This command is used with the E-Series power sensors and N8480 Series power sensors (excluding Option CFT) to select one of two power ranges.

- If 0 is selected, the power sensor's lower range is selected.
- If 1 is selected, the power sensor's upper range is selected.

Setting a range with this command automatically switches

[SENSe[1]] | SENSe2:POWer:AC:RANGe:AUTO to OFF.

Syntax

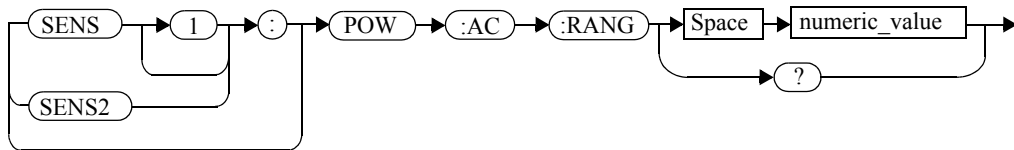

Example

```
POW:AC:RANG 0
```

This command sets the power sensor to its lower range.

Reset Condition

On reset, the upper range is selected.

Query

```
[SENSe[1]] | SENSe2:POWer:AC:RANGe?
```

The query enters a 1 or 0 into the output buffer indicating the status of the power sensor's range.

- 1 is returned when the upper range is selected.
- 0 is returned when the lower range is selected.

Query Example

```
POW:AC:RANG?
```

This command queries the current setting of the power sensor range.

Error Messages

This command is used with the E-Series power sensors and N8480 Series power sensors (excluding Option CFT). If one is not connected the error -241, "Hardware missing" occurs.

[SENSe[1]]|SENSe2:POWer:AC:RANGe:AUTO <boolean>

This command is used with the E-Series power sensors and N8480 Series power sensors (excluding Option CFT) to enable and disable autoranging. When autoranging is ON, the power meter selects the best measuring range for the measurement. When autoranging is set to OFF, the power meter remains in the currently set range.

The [SENSe[1]]|SENSe2:POWer:AC:RANGe command disables autoranging.

If INITiate:CONTinuous is set to ON and TRIGger:SOURce is set to IMMEDIATE, the range will track the input power if

[SENSe[1]]|SENSe2:POWer:AC:RANGe:AUTO is ON.

If the power meter is not making measurements then autoranging only occurs when the power meter is triggered.

Syntax

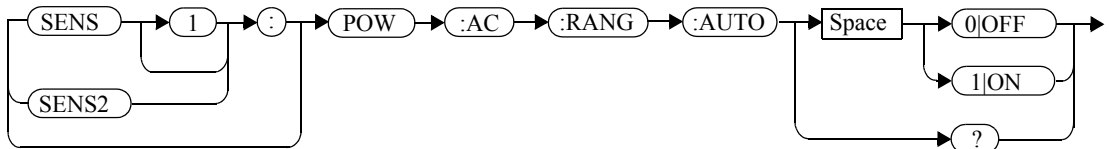

Example

POW:AC:RANG:AUTO 0

This command disables autoranging.

Reset Condition

On reset, autoranging is enabled.

Query

[SENSe[1]]|SENSe2:POWer:AC:RANGe:AUTO?

The query enters a 1 or 0 into the output buffer indicating the status of autoranging.

- 1 is returned when autoranging is enabled.
- 0 is returned when autoranging is disabled.

Query Example

POW:AC:RANG:AUTO?

This command queries whether autoranging is on or off.

SENSe Subsystem
[SENSe[1]]|SENSe2:POWer:AC:RANGe:AUTO <boolean>

Error Messages

If this command is set to OFF and E-Series power sensor or N8480 Series power sensor (excluding Option CFT) is not connected, the error, -241, “Hardware missing” occurs.

[SENSe[1]]|SENSe2:SPEEd <numeric_value>

This command sets the measurement speed on the selected channel. The speeds available are 20, 40 and 200 readings/second.

Note

This command is included for compatibility purposes only. It has the same purpose as [SENSe[1]]|SENSe2:MRATe <NORMAl|DOUBle|FAST> (with 20 mapping to NORMAl, 40 to DOUBle and 200 to FAST), which should be used in preference.

When a channel is set to 200 readings/second the following couplings occur:

Command	Status
[SENSe[1]] SENSe2:AVERAge:STATe	OFF ¹
[SENSe[1]] SENSe2:CORRection:DCYClE:STATe	OFF ¹
[SENSe[1]] SENSe2:CORRection:GAIN2:STATe	OFF ¹
CALCulate[1 2 3 4]:GAIN:STATe	OFF ²
CALCulate[1 2 3 4]:RELative:STATe	OFF ²
CALCulate1 3:MATH:EXPRession	"(SENSe1)"
CALCulate2 4:MATH:EXPRession	"(SENSe2)" ³

1. This change only occurs on the channel specified in the SENSe:SPEEd command. When the specified channel is changed from 200 readings/second to either 20 or 40 readings/second the settings that were in place when 200 readings/second mode was entered are restored.
2. This change occurs when either channel is set to 200 readings/second. When both channels are changed from 200 readings/second to either 20 or 40 readings/second the settings that were in place when 200 readings/second mode was entered are restored.
3. Applicable to the E4417A dual channel power meter only.

Syntax

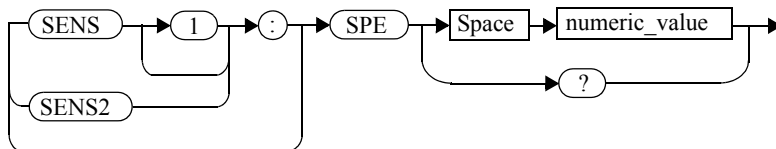

Parameters

Item	Description/Default	Range of Values
numeric_value	A numeric value for the measurement speed in readings per second. The default is 20.	20 ¹ 40 ¹ 200

1. When a channel is set to 20 or 40 readings/second, TRIG:COUNT is set automatically to 1.

Example

SPE 40

This command sets the channel A speed to 40 readings/second.

Reset Condition

On reset, the speed is set to 20 readings/second.

Query

[SENSe[1]]|SENSe2:SPEed?

The query returns the current speed setting, either 20, 40 or 200.

Query Example

SPE?

This command queries the current speed setting for channel A.

Error Messages

- If <speed> is not 20, 40 or 200, error -224 “Illegal parameter value” occurs.
- If an E-Series power sensor is not connected and the <numeric_value> is set to 200 readings/second, error -241 “Hardware missing” occurs.
- If TRIG:SOUR is set to EXTERNAL or INTERNAL[[1]|2], error -221 “Settings Conflict” occurs.

SENSe[1]]SENSe2:SWEep[1]|2|3|4 Commands

These commands set offset time and time gate length as illustrated in the following diagram:

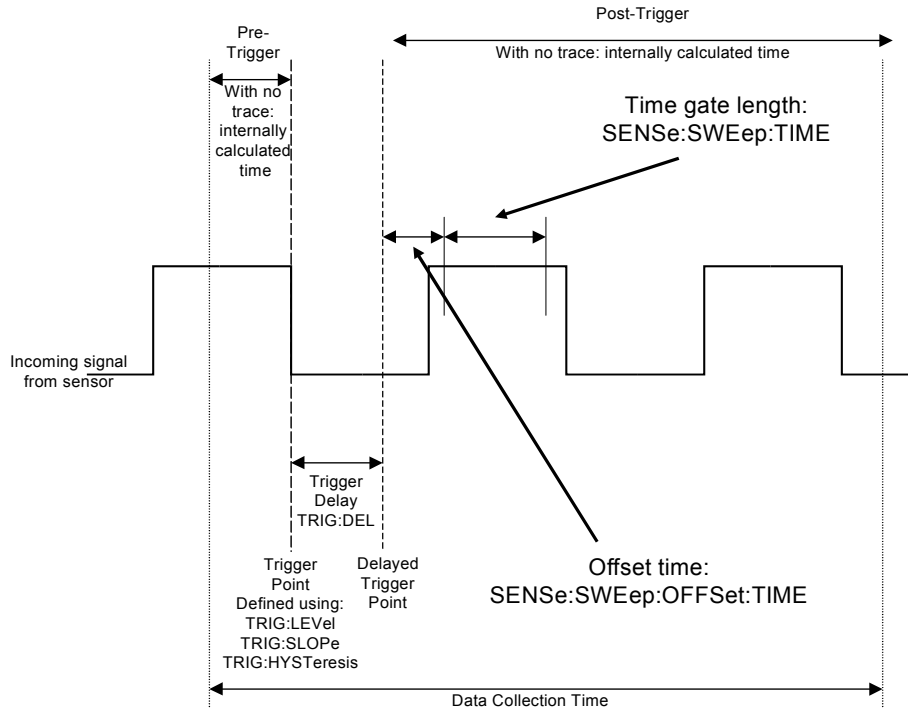

Offset time and time gate length values can be set for up to four measurement gates per channel. Measurement gate number is defined by the numeric value following the SWEEP component of the command.

Note

These commands can only be used with E9320 sensors which must be set to NORMa1 mode.

The following commands are detailed in this section:

```
[SENSe[1]] |SENSe2:SWEep[1]|2|3|4:OFFSet:TIME
<numeric_value>
```

```
[SENSe[1]] |SENSe2:SWEep[1]|2|3|4:TIME <numeric_value>
```

[SENSe[1]]|SENSe2:SWEep[1]|2|3|4:OFFSet:TIME <numeric_value>

This command sets the delay between the delayed trigger point and the start of the time-gated period (the offset time) for E9320 sensors which are set to NORMAl mode.

To set an E9320 sensor to NORMAl mode, refer to the command

[SENSe[1]]|SENSe2:DETEctor:FUNCTion <character_data>
on page 9-40.

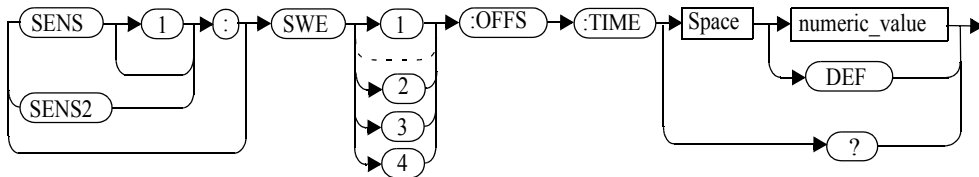
Syntax**Parameters**

Item	Description/Default	Range of Values
numeric_value	The delay between the trigger point and the start of the time-gated period. <ul style="list-style-type: none"> DEF: the default value is 0 seconds. Units are resolved to 1 ns.	-1 to 1 seconds DEF

Example

SENS2:SWE3:OFFS:TIME 1.001 *This command sets the delay to 1.001 seconds.*

Reset Condition

On reset, the value is set to 0 seconds.

Query

SENSe[1]]|SENSe2:SWEep[1]|2|3|4:OFFSet:TIME?

The query returns the current delay between the trigger point and the start of the time-gated period.

Query Example

SENS2 : SWE2 : OFFS : TIME ?

The query returns the current delay between the trigger point and the start of the time-gated period for channel B and gate 2.

Error Messages

- If the command is used when a non E9320 sensor is connected, the error -241, “Hardware missing” occurs.
- If the command is used when an E9320 sensor is connected and set to AVERage mode rather than NORMal mode, the error -221, “Settings Conflict” occurs.

[SENSe[1]]|SENSe2:SWEep[1]|2|3|4:TIME <numeric_value>

This command sets the length of the time-gated period (time-gate length) for time-gated measurements for E9320 sensors which are set to NORMAl mode. To set an E9320 sensor to NORMAl mode, refer to the command

[SENSe[1]] | SENSe2:DETECTOR:FUNCTION <character_data>
on page 9-40.

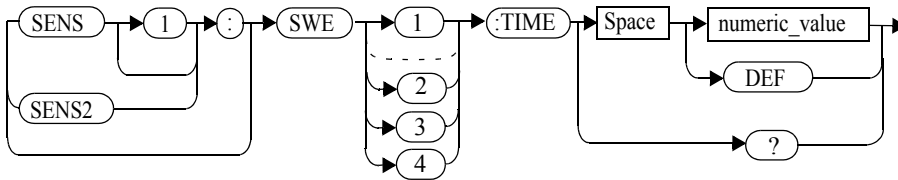
Syntax**Parameters**

Item	Description/Default	Range of Values
numeric_value	The length of the time gated period in seconds. <ul style="list-style-type: none"> DEF: the default value is 100 us Units are resolved to 1 ns.	0 to 1 second DEF

Example

```
SENSe2:SWE3:TIME 0.001
```

This command sets the length to 0.001 seconds.

Reset Condition

On reset, gate 1 is set to 100us and other gates to 1s.

Query

```
SENSe[1]] | SENSe2:SWEep[1] | 2 | 3 | 4 :TIME?
```

The query returns the current length of the time-gated period.

Query Example

SENS2 : SWE2 : TIME?

This command queries the length of the time-gated period for channel B and gate 2.

Error Messages

- If the command is used when a non E9320 sensor is connected, the error -241, “Hardware missing” occurs.
- If the command is used when an E9320 sensor is connected and set to AVERAge mode rather than NORMa1 mode, the error -221, “Settings Conflict” occurs.

SENSe[1]]SENSe2:TRACe Commands

These commands are used to set:

- The upper and lower limits for the trace display.
- The delay between the delayed trigger point and the start of the trace.
- The duration of the trace.
- The trace units.

Note

These commands can only be used with E9320 sensors which are set to *NORMAL* mode.

The following commands are detailed in this section:

```
[SENSe[1]] |SENSe2:TRACe:LIMit:LOWer <numeric_value>  
[SENSe[1]] |SENSe2:TRACe:LIMit:UPPer <numeric_value>  
[SENSe[1]] |SENSe2:TRACe:OFFSet:TIME <numeric_value>  
[SENSe[1]] |SENSe2:TRACe:TIME <numeric_value>  
[SENSe[1]] |SENSe2:TRACe:UNIT <character_data>
```

SENSe[1]|2:TRACe:LIMit:LOWer <numeric_value>

This command sets the lower scale limit of the trace for the specified channel.

The units used are dependent on the current setting of `SENS:TRAC:UNIT` as shown in the following table:

Table 0-13: Measurement Units

Units: SENS:TRAC:UNIT	Units: SENS:TRAC:LIM:LOW
dBm	dBm
W	W

Note

The trace lower scale limit is maintained at a lower power than the upper scale limit which is adjusted to be slightly greater than the lower scale limit if necessary. Refer to `SENSe[1]|2:TRACe:LIMit:UPPer <numeric_value>` for further information on setting the trace upper scale limit.

Syntax

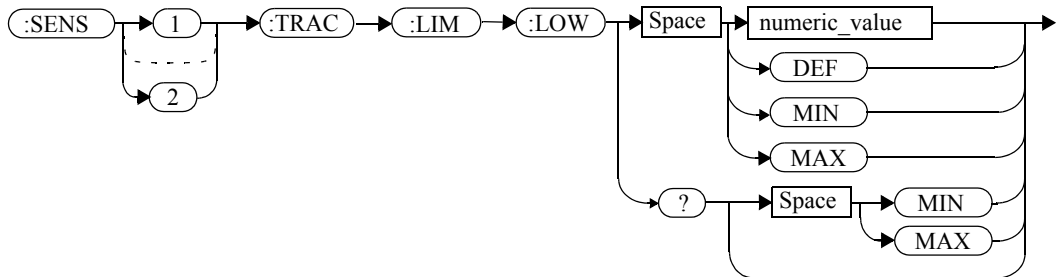

Parameters

Item	Description/Default	Range of Values
numeric_value	<p>A numeric value for the trace lower scale limit.</p> <ul style="list-style-type: none"> • DEF: the default is 20 dBm • MIN: -150 dBm • MAX: 230 dBm <p>Units used are resolved to 1 dBm</p>	<p>-150 to 230 dBm</p> <p>DEF</p> <p>MIN</p> <p>MAX</p>

Example

```
SENS2:TRAC:LIM:LOW 10
```

This command sets the trace lower scale limit to 10 dBm for channel B.

Reset Condition

On reset, the value is set to -50 dBm.

Query

```
SENSe[1] | 2:TRACe:LIMit:LOWer [MIN|MAX]
```

The query returns the current setting of the trace lower scale limit or the value associated with MIN or MAX. The format of the response is <NR3>.

Query Example

```
SENSe:TRAC:LIM:LOW?
```

This command queries the trace lower scale limit of channel A.

SENSe[1]|2:TRACe:LIMit:UPPer <numeric_value>

This command sets the upper scale limit of the trace for the specified channel.

The units used are dependent on the current setting of `SENS:TRAC:UNIT` as shown in the following table:

Table 0-14: Measurement Units

Units: SENS:TRAC:UNIT	Units: SENS:TRAC:LIM:UPP
dBm	dBm
W	W

Note

The trace lower scale limit is maintained at a lower power than the upper scale limit which is adjusted to be slightly greater than the lower scale limit if necessary. Refer to `SENSe[1]|2:TRACe:LIMit:LOWer <numeric_value>` for further information on setting the trace lower scale limit.

Syntax

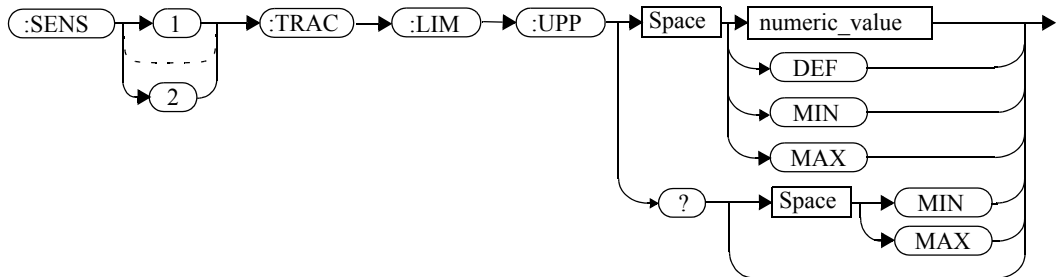

Parameters

Item	Description/Default	Range of Values
numeric_value	A numeric value for the trace upper scale limit. <ul style="list-style-type: none">• DEF: the default is 20 dBm• MIN: -150 dBm• MAX: 230 dBm Units used are resolved to 1 dBm	-150 to 230 dBm DEF MIN MAX

Example

```
SENS:TRAC:LIM:UPP 100
```

This command sets the trace upper scale limit to 100 dBm for channel A.

Reset Condition

On reset, the value is set to DEF.

Query

```
SENSe[1]|2:TRACe:LIMit:LOWer [MIN|MAX]
```

The query returns the current setting of the trace upper scale limit or the value associated with MIN or MAX. The format of the response is <NR3>.

Query Example

```
SENS:TRAC:LIM:UPP?
```

This command queries the trace upper scale limit of channel A.

[SENSe[1]]|SENSe2:TRACe:OFFSet:TIME <numeric_value>

This command sets the delay between the delayed trigger point and the start of the trace for E9320 sensors which are set to NORMAl mode.

To set an E9320 sensor to NORMAl mode, refer to the command

[SENSe[1]]|SENSe2:DETEctor:FUNCTion <character_data>
 on page 9-40.

syntax

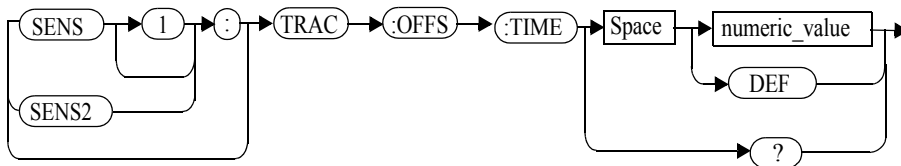

Parameters

Item	Description/Default	Range of Values
numeric_value	The length of the delay in seconds. • DEF: the default value is 0 seconds. Units are resolved to 1 ns.	-1 to 1 seconds DEF

Example

SENSe:TRAC:OFFSet:TIME TIME 0.05 *This command sets the delay to 0.05 seconds.*

Reset Condition

On reset, the delay is set to 0 seconds.

Query

SENSe[1]|SENSe2:TRACe:OFFSet:TIME?

The query returns the current delay between the delayed trigger point and the start of the trace.

Query Example

SENS:TRAC:OFFS:TIME?

This command queries the current delay between the delayed trigger point and the start of the trace for channel A.

Error Messages

- If the command is used when a non E9320 sensor is connected, the error -241, “Hardware missing” occurs.
- If the command is used when an E9320 sensor is connected and set to AVERAge mode rather than NORMa1 mode, the error -221, “Settings Conflict” occurs.

[SENSe[1]]|SENSe2:TRACe:TIME <numeric_value>

This command sets the duration of the trace for E9320 sensors which are set to NORMa1 mode. To set the E9320 sensor to NORMa1 mode, refer to the command `SENSe[1]|SENSe2:DETECTOR:FUNCTION <character_data>` on page 9-40.

Syntax

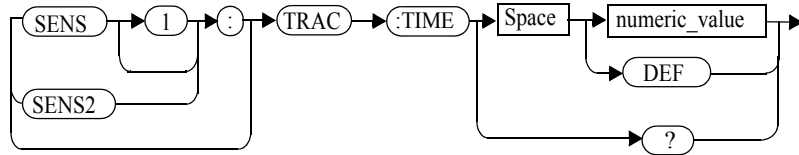

Parameters

Item	Description/Default	Range of Values
numeric_value	The duration of the trace in seconds. • DEF: the default value is 100 us. Units are resolved to 1 ns.	10 us to 1 second DEF

Example

`SENS2:TRAC:TIME 0.5`

This command sets the duration of the trace to 0.5 seconds for channel B.

Reset Condition

On reset, the duration is set to 100 us.

Query

`SENSe[1]|SENSe2:TRACe:TIME?`

The query returns the current duration of the trace.

Query Example

SENS2 : TRAC : TIME ?

This command queries the current duration of the trace.

Error Messages

- If the command is used when a non E9320 sensor is connected, the error -241, “Hardware missing” occurs.
- If the command is used when an E9320 sensor is connected and set to AVERAge mode rather than NORMa1 mode, the error -221, “Settings Conflict” occurs.

[SENSe[1]]|SENSe2:TRACe:UNIT <character_data>

This command sets the units for the trace for the specified channel.

Syntax

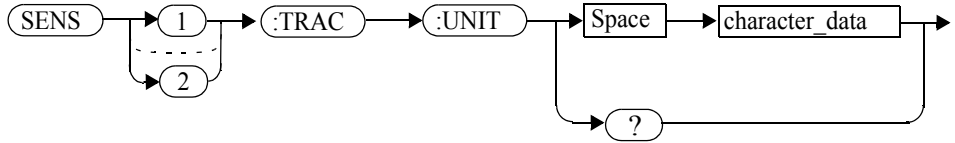

Parameters

Item	Description/Default	Range of Values
character_data	<ul style="list-style-type: none"> • DBM: dBm. • W: Watts. 	DBM W

Example

`SENS2:TRAC:UNIT W`

This command sets the trace units for channel B to Watts.

Reset Condition

On reset the units are set to dBm.

Query

`[SENSe[1]]|SENSe2:TRACe:UNIT?`

The query command returns the current value of character_data.

Query Example

`SENS2:TRAC:UNIT?`

This command queries the current trace units for channel B.

[SENSe[1]]|SENSe2:V2P ATYPe|DTYPe

This command is used to select the type of linearity correction that will be applied to the channel sensors being used. For most 8480 Series power sensors, the correct (A type or D type) linearity correction table is automatically selected. However, for the V8486A and W8486A sensors the automatic selection must be overridden and the D type (diode) correction selected.

Note This command is only applicable for V8486A and W8486A sensors.

Syntax

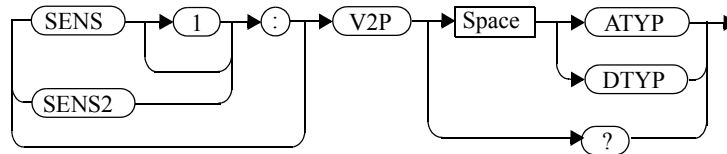

Example

```
SENS2 :V2P DTYP
```

This command selects the D type linearity correction to be applied to channel B.

Reset Condition

On reset, the linearity correction is set for A type.

Query

```
[SENSe[1]] |SENSe2:V2P?
```

The query returns the current type of linearity correction being displayed on the screen.

Query Example

```
SENS :V2P?
```

This command queries which linearity correction type is currently being displayed on the screen.

Error Messages

If no sensor is connected or the sensor is not an A type, the error -241, “Hardware missing” occurs.

10

———— **STATus Subsystem**

STATus Subsystem

The STATus command subsystem enables you to examine the status of the power meter by monitoring the following status registers:

- Device status register.
- Operation status register.
- Questionable status register.

The contents of these and other registers in the power meter are determined by one or more status registers.

Table 0-15 summarizes the effects of various commands and events on these status registers:

Table 0-15: Commands and events affecting Status Registers

Status Register	*RST	*CLS	Power On	STATus: PRESet
SCPI Transition Filters (NTR and PTR registers)	none	none	preset	preset
SCPI Enable Registers	none	none	preset	preset
SCPI Event Registers	none	clear	clear	none
SCPI Error/Event Queue enable	none	none	preset	preset
SCPI Error/Event Queue	none	clear	clear	none
IEEE488.2 Registers ESE SRE	none	none	clear	none
IEEE488.2 Registers SESR STB	none	clear	clear	none

The contents of the status registers are examined using the following status register set commands:

```
:CONDition?
:ENABle <NRf>|<non-decimal numeric>
[:EVENT?]
:NTRansition <NRf>|<non-decimal numeric>
:PTRansition <NRf>|<non-decimal numeric>
```

Each of these can be used to examine any of the following eleven status registers:

STATus:DEVIce (page 10-8)
STATus:OPERation (page 10-11)
STATus:OPERation:CALibrating[:SUMMARY] (page 10-12)
STATus:OPERation:LLFail[:SUMMARY] (page 10-13)
STATus:OPERation:MEASuring[:SUMMARY] (page 10-14)
STATus:OPERation:SENSe[:SUMMARY] (page 10-15)
STATus:OPERation:TRIGger[:SUMMARY] (page 10-16)
STATus:OPERation:ULFail[:SUMMARY] (page 10-17)
STATus:QUEStionable (page 10-20)
STATus:QUEStionable:CALibration[:SUMMARY] (page 10-21)
STATus:QUEStionable:POWer[:SUMMARY] (page 10-22)

Examples:

- To use the :CONDition? command to examine the STATus:DEVIce register:
STATus:DEVIce:CONDition?
- To use the :NTRansition command to examine the
STATus:OPERation:SENSe[:SUMMARY] register:
STATus:OPERation:SENSe[:SUMMARY]:NTRansition

This chapter describes the status register set commands and the status registers which they are used to examine.

Status Register Set Commands

This section describes the five status register set commands. Each can be used to examine all of the eleven status registers listed on the previous page.

To apply a command to a specific register, prefix the command with the name of the appropriate register. For example, to apply the `:ENABle` command to the `STATus:QUESTionable` register, use the following command:

```
STATus:QUESTionable:ENABle.
```

The Status Register Set commands detailed in this section are:

Keyword	Parameter Form	Notes	Page
<code>:CONDition?</code>		[query only]	page 10-4
<code>:ENABle</code>	<code><NRf> <non-decimal numeric></code>		page 10-5
<code>[:EVENT?]</code>		[query only]	page 10-4
<code>:NTRansition</code>	<code><NRf> <non-decimal numeric></code>		page 10-6
<code>:PTRansition</code>	<code><NRf> <non-decimal numeric></code>		page 10-7

:CONDition?

This query returns a 16 bit decimal-weighted number representing the bits set in the Condition Register of the SCPI Register Set you require to control. The format of the return is `<NR1>` in the range of 0 to 32767 ($2^{15}-1$). The contents of the Condition Register remain unchanged after it is read.

Syntax



[:EVENT]?

This query returns a 16 bit decimal-weighted number representing the bits set in the Event Register of the SCPI Register Set you require to control. The format of the return is `<NR1>` in the range of 0 to 32767 ($2^{15}-1$). This query clears all bits in the register to 0.

Syntax



:ENABLE <NRf>|<non-decimal numeric>

This command sets the Enable Register of the particular SCPI Register Set you require to control. The parameter value, when rounded to an integer and expressed in base 2 has it's first 15 bits written into the Enable Register of the SCPI Register Set concerned. The last bit (bit 15) is always set to 0.

Syntax

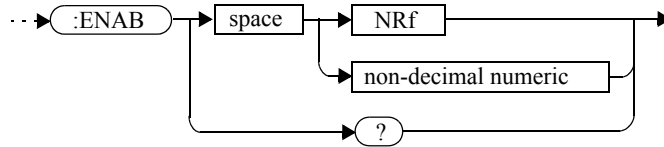

Parameters

Type	Description	Range of Values
NRf	The value used to set the Enable Register.	0 to $2^{16}-1$
non-decimal numeric		

Query

:ENABle?

The query returns a 15 bit decimal-weighted number representing the contents of the Enable Register of the SCPI Register Set being queried. The format of the return is <NR1> in the range of 0 to 32767 ($2^{15}-1$).

:NTRansition <NRf>|<non-decimal numeric>

This command sets the Negative Transition Register of the SCPI Register Set you require to control. The parameter value, when rounded to an integer and expressed in base 2 has it's first 15 bits written into the Negative Transition Register of the SCPI Register Set concerned. The last bit (bit 15) is always set to 0.

Syntax

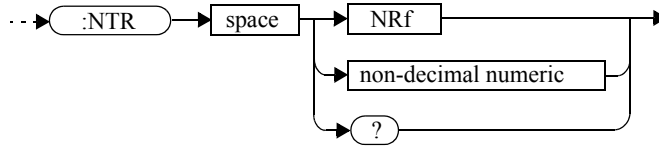

Parameters

Type	Description	Range of Values
NRf	The value used to set the NTR Register.	0 to $2^{16}-1$
non-decimal numeric		

Query

:NTRansition?

The query returns a 15 bit decimal-weighted number representing the contents of the Negative Transition Register of the SCPI register set being queried. The format of the return is <NR1> in the range of 0 to 32767 ($2^{15}-1$).

:PTRansition <NRf>|<non-decimal numeric>

This command is used to set the Positive Transition Register of the SCPI Register Set you require to control. The first 15 bits of the input parameter are written into the Positive Transition Register of the SCPI Register Set concerned. The last bit (bit 15) is always set to 0.

Syntax

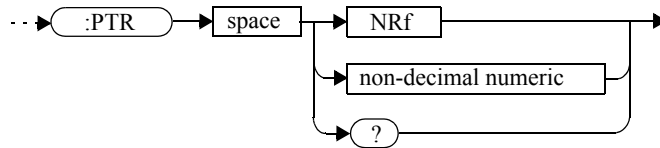

Parameters

Type	Description	Range of Values
NRf	The value used to set the PTR Register.	0 to $2^{16}-1$
non-decimal numeric		

Query

:PTRansition?

The query returns a 15 bit decimal-weighted number representing the contents of the Positive Transition Register of the SCPI register set being queried. The format of the return is <NR1> in the range of 0 to 32767 ($2^{15}-1$).

Device Status Register Sets

The status registers contain information which give device status information. The contents of the individual registers of these register sets may be accessed by appending the commands listed in “Status Register Set Commands”.

The following command descriptions detail the SCPI register you require to control but do not detail the register set commands.

The one device status register set is:

STATus:DEVIce:

The following bits in these registers are used by the power meter:

Bit Number	Decimal Weight	Definition
0	-	Not used
1	2	Channel A sensor connected
2	4	Channel B sensor connected (E4417A only)
3	8	Channel A sensor error
4	16	Channel B sensor error (E4417A only)
5	32	Channel A sensor Front/Rear
6	64	Channel B sensor Front/Rear (E4417A only)
7-15	-	Not used
14	16384	Front Panel key press
15	-	Bit 15 always 0

The Channel A and B sensor connected bits (bits 1 and 2), when queried with the `STATus:DEVIce:CONDition?` query are set to:

- 1, when a power sensor is connected.
- 0, when no power sensor is connected.

The Channel A and B sensor connected bits (bits 1 and 2), when queried with the `STATus:DEVIce:EVENT?` query indicate whether a power sensor has been connected or disconnected depending on the state of the corresponding bits of `STATus:DEVIce:NTRansition` and `STATus:DEVIce:PTRansition`. If the corresponding bit in:

- `STATus:DEVIce:NTRansition` is 1, then `STATus:DEVIce:EVENT?` is set when a power sensor is disconnected. Note, querying `STATus:DEVIce:EVENT?` clears the `STATus:DEVIce:EVENT?` register.
- `STATus:DEVIce:PTRansition` is 1, then `STATus:DEVIce:EVENT?` is set when a power sensor is connected. Note, querying `STATus:DEVIce:EVENT?` clears the `STATus:DEVIce:EVENT?` register.

The Channel A and B sensor error bits (3 and 4) are set to:

- 1, if the Agilent E-Series or N8480 Series power sensor EEPROM has failed or if there are power sensors connected to both the rear and front panel connectors.
- 0, for every other condition.

The Channel A and B sensor Front/Rear bits (bits 5 and 6) are set to:

- 1, if the power sensor is connected to the rear panel.
- 0, if the power sensor is connected to the front panel.

The Front Panel key press bit (bit 14), when queried with the `STATus:DEVIce:EVENT?` query indicates whether any front panel keys have been pressed since power up or since you last queried the device status register. This bit ignores the `:NTRansition`, and `:PTRansition` registers and `a:CONDition?` query always returns a 0.

Operation Register Sets

The following registers contain information which is part of the power meter's normal operation. The contents of the individual registers of these register sets may be accessed by appending the commands listed in "Status Register Set Commands".

The following command descriptions detail the SCPI register you require to control but do not detail the Register Set commands.

The seven Operation Register Sets are:

```
STATUS:OPERation  
STATus:OPERation:CALibrating[:SUMMARY]  
STATus:OPERation:LLFail[:SUMMARY]  
STATus:OPERation:MEASuring[:SUMMARY]  
STATus:OPERation:SENSe[:SUMMARY]  
STATus:OPERation:TRIGger[:SUMMARY]  
STATus:OPERation:ULFail[:SUMMARY]
```

Further information on these register sets is provided on the following pages.

STATus:OPERation

The operation status register set contains conditions which are a part of the operation of the power meter as a whole.

The following bits in these registers are used by the power meter:

Bit Number	Decimal Weight	Definition
0	1	CALibrating Summary
1 - 3	-	Not used
4	16	MEASuring Summary
5	32	Waiting for TRIGger Summary
6 - 9	-	Not used
10	1024	SENSE Summary
11	2048	Lower Limit Fail Summary
12	4096	Upper Limit Fail Summary
13 to 15	-	Not used (bit 15 always 0)

Syntax



STATus:OPERation:CALibrating[:SUMM]ary

The operation status calibrating summary register set contains information on the calibrating status of the power meter.

The following bits in these registers are used by the power meter:

Bit Number	Decimal Weight	Definition
0	-	Not used
1	2	Channel A CALibrating Status
2	4	Channel B CALibrating Status (E4417A only)
3-15	-	Not used

These bits are set at the beginning of zeroing (`CALibration:ZERO:AUTO ONCE`) and at the beginning of calibration (`CALibration:AUTO ONCE`). Also for the compound command/query `CALibration[:ALL]?`, this bit is set at the beginning of the calibration sequence.

These bits are cleared at the end of zeroing or calibration.

Syntax

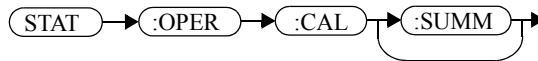

STATus:OPERation:LLFail[:SUMM]ary

The operation status lower limit fail summary register set contains information on the lower limit fail status of the power meter.

The following bits in these registers are used by the power meter:

Bit Number	Decimal Weight	Definition
0	-	Not used
1	2	Channel A LLFail Status
2	4	Channel B LLFail Status (E4417A only)
3	8	Upper window LLFail Status
4	16	Lower window LLFail Status
5	32	Upper window lower measurement LLFail Status
6	64	Lower window lower measurement LLFail Status
7-15	-	Not used

The appropriate bits are set if a channel lower limit test fails or a window lower limit test fails.

These bits are cleared if a measurement is made and the test is enabled and passes.

Syntax

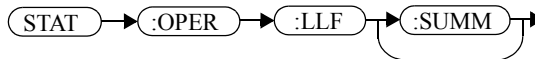

STATus:OPERation:MEASuring[:SUMM]ary]

The operation status measuring summary register set contains information on the measuring status of the power meter.

The following bits in these registers are used by the power meter:

Bit Number	Decimal Weight	Definition
0	-	Not used
1	2	Channel A MEASuring Status
2	4	Channel B MEASuring Status (E4417A only)
3-15	-	Not used

These bits are set when the power meter is taking a measurement.

These bits are cleared when the measurement is finished.

Syntax

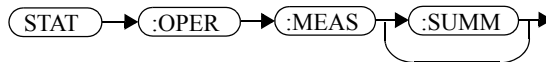

Note

The operation status measuring summary is available only in average mode. Refer to the *Agilent N1911A/1912A P-Series Power Meters Programming Guide*, Page 791/793, example 2, on measurement polling when using a VEE Programme.

STATus:OPERation:SENSe[:SUMMARY]

The operation status sense summary register set contains information on the status of the power sensors.

The following bits in these registers are used by the power meter:

Bit Number	Decimal Weight	Definition
0	-	Not used
1	2	Channel A SENSe Status
2	4	Channel B SENSe Status (E4417A only)
3-15	-	Not used

These bits are set when the power meter is reading data from the Agilent E-Series or N8480 Series power sensor EEPROM.

These bits are cleared when the power meter is not reading data from the Agilent E-Series or N8480 Series power sensor EEPROM.

Syntax

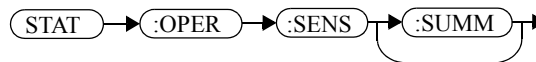

STATus:OPERation:TRIGger[:SUMMARY]

The operation status trigger summary register set contains information on the trigger status of the power meter.

The following bits in these registers are used by the power meter:

Bit Number	Decimal Weight	Definition
0	-	Not used
1	2	Channel A TRIGger Status
2	4	Channel B TRIGger Status (E4417A only)
3-15	-	Not used

Syntax

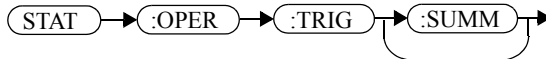

STATus:OPERation:ULFail[:SUMMARY]

The operation status upper limit fail summary register set contains information on the upper limit fail status of the power meter.

The following bits in these registers are used by the power meter:

Bit Number	Decimal Weight	Definition
0	-	Not used
1	2	Channel A ULFail Status
2	4	Channel B ULFail Status (E4417A only)
3	8	Upper window ULFail Status
4	16	Lower window ULFail Status
5	32	Upper window lower measurement LLFail Status
6	64	Lower window lower measurement LLFail Status
7-15	-	Not used

The appropriate bits are set if a channel upper limit test fails or a window upper limit test fails.

These bits are cleared if a measurement is made and the test is enabled and passes.

Syntax

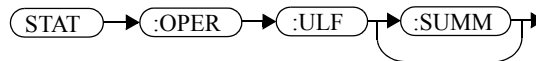

STATus:PRESet

PRESet sets a number of the status registers to their preset values as shown below - all other registers are unaffected. Bit 15 is always 0.

Register	Filter/Enable	PRESet Value
OPERational	ENABle	all zeros
	PTR	all ones
	NTR	all zeros
QUESTionable	ENABle	all zeros
	PTR	all ones
	NTR	all zeros
All Others	ENABle	all ones
	PTR	all ones
	NTR	all zeros

Syntax



Questionable Register Sets

The questionable register sets contain information which gives an indication of the quality of the data produced by the power meter. The contents of the individual registers in these register sets may be accessed by appending the commands listed in “Status Register Set Commands”.

The following command descriptions detail the SCPI register you require to control but do not detail the register set commands.

The three questionable register sets are:

```
STATus:QUESTionable  
STATus:QUESTionable:CALibration[:SUMMARY]  
STATus:QUESTionable:POWER[:SUMMARY]
```

STATus:QUEStionable

The questionable register set contains bits which give an indication of the quality of various aspects of signals processed by the power meter as a whole.

The following bits in these registers are used by the power meter:

Bit Number	Decimal Weight	Definition
0 to 2	-	Not used
3	8	POWer Summary
4 to 7	-	Not used
8	256	CALibration Summary
9	512	Power On Self Test
10 to 15	-	Not Used (bit 15 always 0)

Bit 3 is set by the logical OR outputs of the
STATus:QUEStionable:POWer:SUMMary register set.

Bit 8 is set by the logical OR outputs of the
STATus:QUEStionable:CALibration:SUMMary register set.

Bit 9 is set if power-on self-test fails, and cleared if it passes.

Syntax

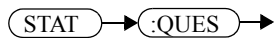

STATus:QUEStionable:CALibration[:SUMM]ary

The questionable calibration summary register set contains bits which give an indication of the quality of the data produced by the power meter due to its calibration status.

The following bits in these registers are used by the power meter:

Bit Number	Decimal Weight	Definition
0	-	Not used
1	2	Summary of Channel A CALibration
2	4	Summary of Channel B CALibration (E4417A only)
3-15	-	Not used

These bits are set by the following:

- Error -231, “Data questionable; CH<A|B>:ZERO ERROR”
- Error -231, “Data questionable; CAL ERROR”
- Error -231, “Data questionable; CAL ERROR ChA”
- Error -231, “Data questionable; CAL ERROR ChB”

These bits are cleared when any of the three commands listed above succeed and no errors are placed on the error queue.

Syntax

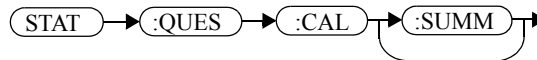

STATus:QUESTionable:POWer[:SUMMary]

The questionable power summary register set contain bits which give an indication of the quality of the power data being acquired by the power meter.

The following bits in these registers shall be used by the power meter:

Bit Number	Decimal Weight	Definition
0	-	Not used
1	2	Channel A Power
2	4	Channel B Power (E4417A only)
3	8	Upper Window Power
4	16	Lower Window Power
5	32	Channel A Please Zero
6	64	Channel B Please Zero (E4417A only)
7	128	Upper Window Lower Measurement Power
8	256	Lower Window Lower Measurement Power

Bit 1 is set when any of the following errors occur:

- Error -231, “Data questionable;Input Overload” (E4417A only)
- Error -231, “Data questionable;Input Overload ChA” (E4417A only)

Bit 2 is set when the following error occurs:

- Error -231, “Data questionable;Input Overload ChB” (E4417A only)

Bits 3 is set when the following error occurs:

- Error -230, “Data corrupt or stale”
- Error -231, “Data questionable;Upper window log error”

Bit 4 is set when the following error occurs:

- Error -230, “Data corrupt or stale”
- Error -231, “Data questionable;Lower window log error”

Bit 5 is set when the following condition occurs:

- Channel A requires zeroing

Bit 6 is set when the following condition occurs (E4417A only):

- Channel B requires zeroing

These bits are cleared when no errors or events are detected by the power meter during a measurement covering the causes given for it to set.

Syntax

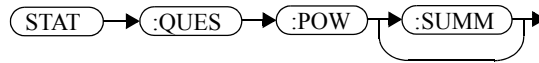

THIS PAGE HAS BEEN INTENTIONALLY LEFT BLANK.

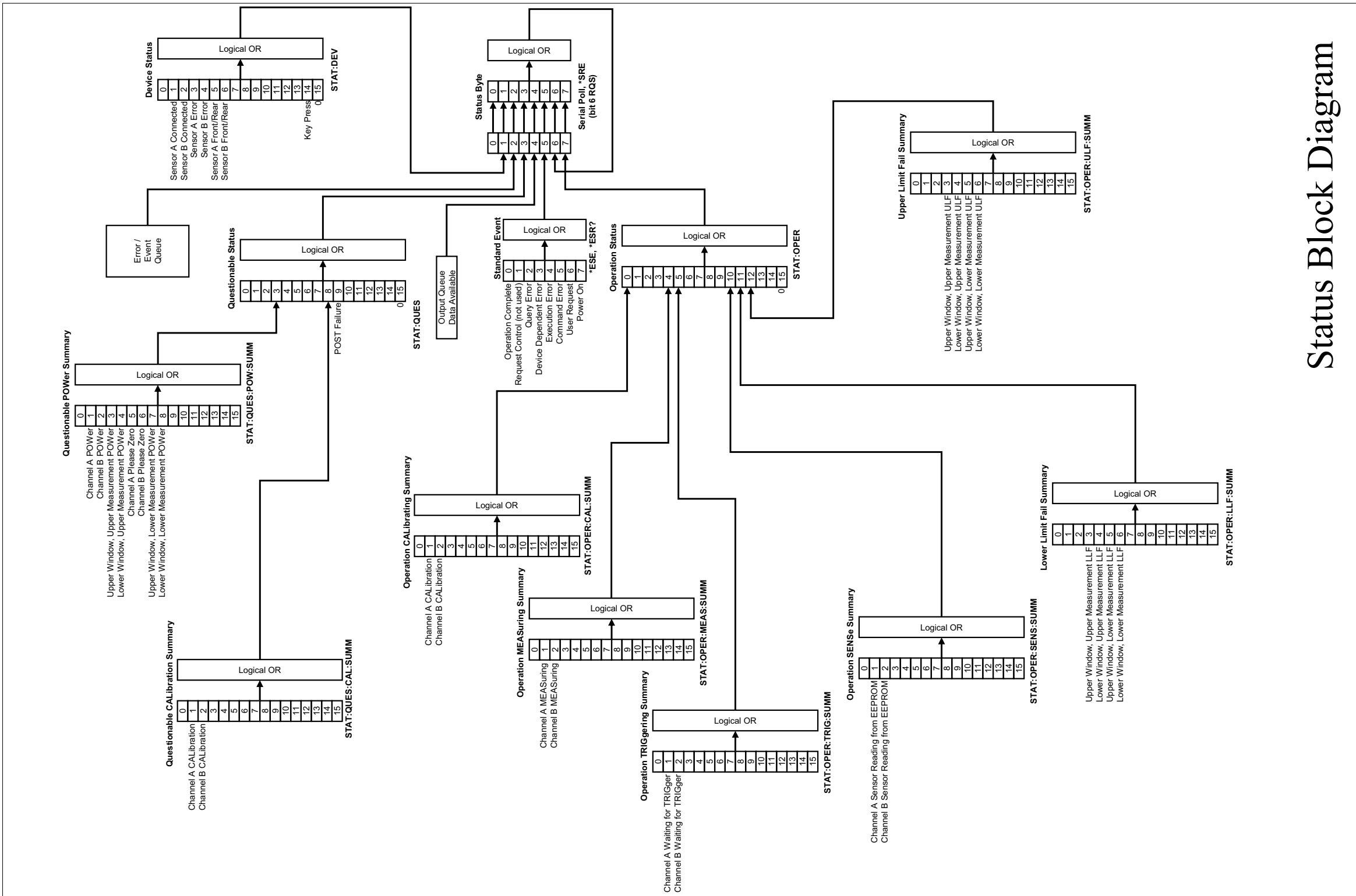

Status Block Diagram

THIS PAGE HAS BEEN INTENTIONALLY LEFT BLANK.

11

———— **SYSTEM Subsystem**

SYSTem Subsystem

The SYSTem command subsystem is used to:

- Return error numbers and messages from the power meter.
- Preset the power meter.
- Select the remote interface type (GPIB, RS232 or RS422).
- Set the GPIB address.
- Set the command language.
- Query the SCPI version.

At a lower level:

- SYSTem:COMMunicate:SERial:CONTRol sets the DTR and RTS signal lines.
- SYSTem:COMMunicate:SERial:CONTRol[:RECeive] and TRANsmit sets baud rate, parity, word length and other serial interface controls.

Keyword	Parameter Form	Notes	Page
SYSTem			
:COMMunicate			
:GPIB			
[:SELF]			
:ADDRESS	<numeric_value>		page 11-4
:SERial			
:CONTRol			
:DTR	<boolean>		page 11-7
:RTS	<boolean>		page 11-8
[:RECeive]			
:BAUD	<numeric_value>		page 11-9
:BITS	<numeric_value>		page 11-11
:PACE	XON NONE		page 11-13
:PARity			
[:TYPE]	EVEN ODD ZERO ONE NONE		page 11-14
:SBITS	<numeric_value>		page 11-16
:TRANsmit			
:AUTO?		[query only]	page 11-17
:BAUD	<numeric_value>		page 11-18
:BITS	<numeric_value>		page 11-20
:ECHO	<boolean>		page 11-21
:PACE	XON NONE		page 11-22
:PARity			
[:TYPE]	EVEN ODD ZERO ONE NONE		page 11-23
:SBITS	<numeric_value>		page 11-25
:HELP			
:HEADers?		[query only]	page 11-26

Keyword	Parameter Form	Notes	Page
:LoCAL			page 11-27
:PRESet	character_data	[event; no query]	page 11-28
:REMoTe			page 11-58
:RINTerface	GPIB RS232 RS422		page 11-59
:RWLock			page 11-60
:VERSiOn?		[query only]	page 11-61

SYSTem:COMMunicate:GPIB[:SELF]:ADDRess <numeric_value>

This command sets the GPIB address of the power meter.

Syntax

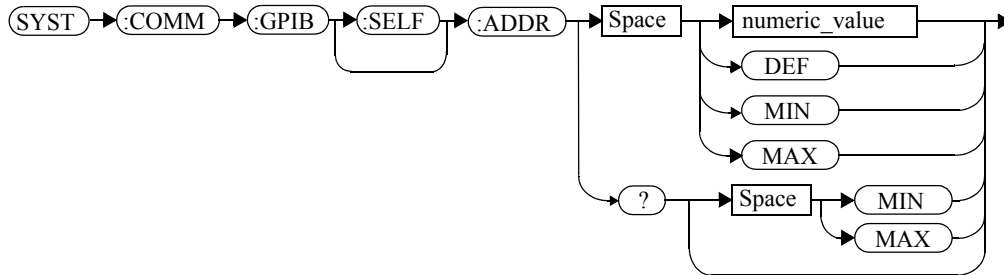

Parameters

Item	Description/Default	Range of Values
numeric_value	A numeric value for the address. <ul style="list-style-type: none"> • DEF: the default value is 13. • MIN: 0. • MAX: 30. 	0 to 30 DEF MIN MAX

Example

SYST:COMM:GPIB:ADDR 13

This command sets the GPIB address to 13.

Query

SYSTem:COMMunicate:GPIB[:SELF]:ADDRess? MIN|MAX

The query returns the current setting of the GPIB address or the values associated with MIN and MAX.

Query Example

SYST:COMM:GPIB:ADDR?

This command queries the setting of the GPIB address.

SYSTem:COMMunicate:Serial Commands

These commands control the settings for the RS232/RS422 serial interface. The commands allow you to:

- Set the function of the DTR and RTS signal lines.
- Set the transmit/receive baud rate.
- Set the transmit/receive word length.
- Set the transmit/receive parity type.
- Set the transmit/receive stop bits.
- Enable /disable XON/XOFF software handshaking.

The following commands are detailed in this section:

```
SYSTem:COMMunicate:SERial:CONTRol:DTR
SYSTem:COMMunicate:SERial:CONTRol:RTS
SYSTem:COMMunicate:SERial:[:RECeive]:BAUD
SYSTem:COMMunicate:SERial:[:RECeive]:BITs
SYSTem:COMMunicate:SERial:[:RECeive]:PACE
SYSTem:COMMunicate:SERial:[:RECeive]:PARity:[TYPE]
SYSTem:COMMunicate:SERial:[:RECeive]:SBITs
SYSTem:COMMunicate:SERial:TRANsmit:AUTO?
SYSTem:COMMunicate:SERial:TRANsmit:BAUD
SYSTem:COMMunicate:SERial:TRANsmit:BITs
SYSTem:COMMunicate:SERial:TRANsmit:ECHO
SYSTem:COMMunicate:SERial:TRANsmit:PARity:[TYPE]
SYSTem:COMMunicate:SERial:TRANsmit:SBITs
```

SYSTem:COMMunicate:SERial:CONTrol:DTR <boolean>

This command sets the serial interface (RS232) DTR signal line either high always (ON) or low always (OFF). In addition, the DTR signal line can be tied to the condition of the interface receiver buffer (IBFull) resulting in the line going high when the receiver is ready to accept data and low when the receiver buffer is full (not ready for data). Also, with DTR in IBFull mode, the transmitter will be inhibited when DSR is low.

Syntax

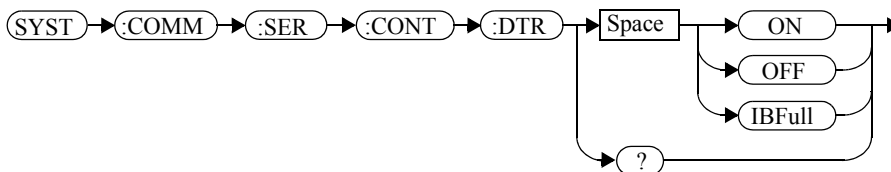

Example

SYST:COMM:SER:CONT:DTR ON *This command sets the DTR signal line high (always).*

Reset Condition

On reset, the DTR signal line setting is unaffected.

Query

SYSTem:COMMunicate:SERial:CONTrol:DTR?

The query returns the current DTR signal line setting, ON, OFF or IBFull.

Query Example

SYST:COMM:SER:CONT:DTR? *This command queries the setting of the DTR signal line.*

Error messages

If the RS422 interface is selected, then the error message -221 “Settings conflict” will occur.

SYSTem:COMMunicate:SERial:CONTrol:RTS <boolean>

This command is used to set the serial interface (RS232 or RS422) RTS signal line either high always (ON) or low always (OFF). In addition, the RTS signal line can be tied to the condition of the interface receiver buffer (IBFull) resulting in the line going high when the receiver is ready to accept data and low when the receiver buffer is full (not ready for data). Also, with RTS in IBFull mode, the transmitter will be inhibited when CTS is low.

Syntax

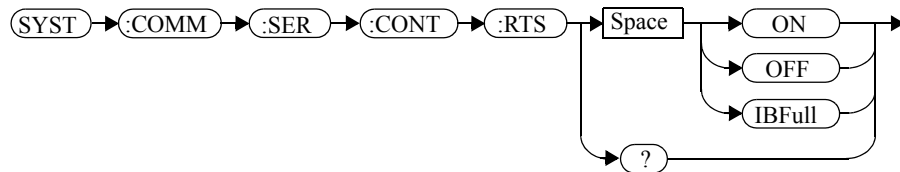

Example

SYST:COMM:SER:CONT:RTS ON *This command sets the RTS signal line high (always).*

Reset Condition

On reset, the condition of the RTS signal line is unaffected.

Query

SYSTem:COMMunicate:SERial:CONTrol:RTS?

The query returns the current RTS signal line setting, ON, OFF or IBFull.

Query Example

SYST:COMM:SER:CONT:RTS? *This command queries the setting of the RTS signal line.*

SYSTem:COMMunicate:SERial[:RECeive]:BAUD <numeric_value>

This command sets the baud rate for both the receiver and the transmitter. The baud rate for the receiver and transmitter are tied together and can either be set by this command or the equivalent transmitter command :TRANsmitt:BAUD.

Syntax

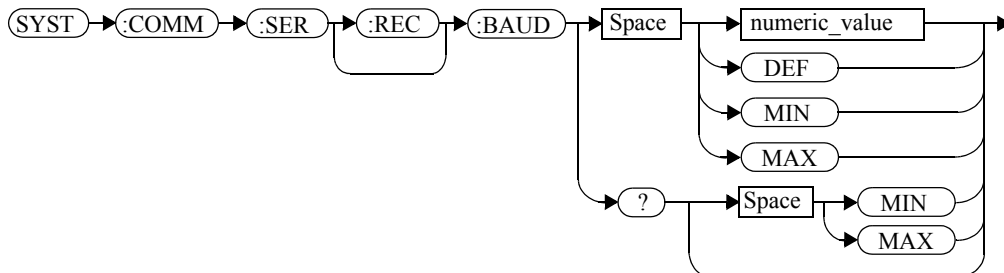

Parameters

Item	Description/Default	Range of Values
numeric_value	A numeric value for the baud rate. <ul style="list-style-type: none"> • DEF: the default value is 9600. • MIN: 50. • MAX: 115200. 	50, 75, 110, 150, 300, 1200, 1800, 2000, 2400, 3600, 4800, 7200, 9600, 19200, 38400, 57600, 115200 DEF MIN MAX

Example

SYST:COMM:SER:REC:BAUD 38400 *This command sets the receiver and transmitter baud rate to 38400.*

Reset Condition

On reset, the baud rate is unaffected.

Query

```
SYSTem:COMMunicate:SERial[:RECEive]:BAUD? MIN|MAX
```

The query returns the current setting of the receive/transmit baud rate or the values associated with MIN and MAX.

Query Example

```
SYST:COMM:SER:REC:BAUD?
```

This command queries the setting of the receive/transmit baud rate.

Error Messages

If the baud rate is not in the range of values shown in the parameter table, the error message -224, “Illegal parameter value” occurs.

SYSTem:COMMunicate:SERial[:RECeive]:BITs <numeric_value>

This command sets the word length for both the receiver and the transmitter. The word length for the receiver and transmitter are tied together and can either be set by this command or the equivalent transmitter command :TRANsmit:BITs.

Syntax

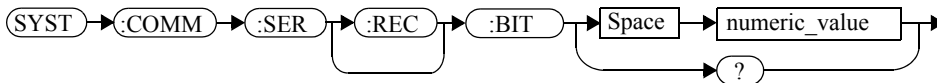

Parameters

Item	Description/Default	Range of Values
numeric_value	A numeric value for the word length	7 or 8

Example

`SYSem:COMM:SER:REC:BITs 8` *This command sets the receiver and transmitter word length to 8.*

Reset Condition

On reset, the word length is unaffected.

Query

`SYSem:COMMunicate:SERial[:RECeive]:BITs?`

The query returns the current setting of the receive/transmit word length.

Query Example

`SYSem:COMM:SER:REC:BITs?` *This command queries the setting of the receive/transmit word length.*

Error Messages

If the word length is not in the range of values shown in the parameter table, then the error message -224, “Illegal parameter value” will occur.

SYSTEM:COMMunicate:SERial[:RECeive]:PACE XON|NONE

This command enables (XON) and disables (NONE) an Xon/Xoff software handshake for the receiver. When enabled, an Xon control character is transmitted when the receiver is ready to accept data and an Xoff control character is transmitted when the receiver is unable to receive further data (not ready for data).

Syntax

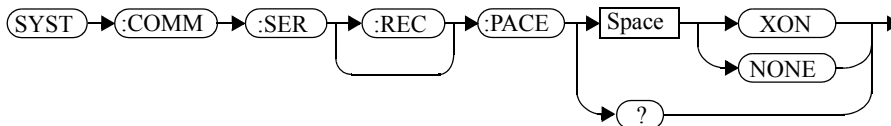

Example

`SYSTEM:COMM:SER:REC:PACE XON` *This command enables the receiver Xon/Xoff software handshake.*

Reset Condition

On reset, pacing is unaffected.

Query

`SYSTEM:COMMunicate:SERial[:RECeive]:PACE?`

The query returns XON if the handshake is enabled and NONE if the handshake is disabled.

Query Example

`SYSTEM:COMM:SER:REC:PACE?` *This command queries whether the receiver Xon/Xoff software handshake is enabled (XON) or disabled (NONE).*

SYSTem:COMMunicate:SERial[:RECeive]:PARity[:TYPE] EVEN|ODD|ZERO|ONE|NONE

This command decides what type of parity checking (if any) will take place on received data and also decides what parity (if any) will be included with transmitted data. The following choices are available and can be set using either this command or the equivalent `TRANsmit:PARity[:TYPE]` command.

Parity Type	Description
EVEN	The receiver expects a parity bit. All data received is checked for even parity. An error is generated if this test fails. Transmitted data includes a parity bit set for even parity indication.
ODD	The receiver expects a parity bit. All data received is checked for odd parity. An error is generated if this test fails. Transmitted data includes a parity bit set for odd parity indication.
ZERO	The receiver expects a parity bit. All data received has the parity checked and if it is not a logic low an error will be generated. Transmitted data includes a parity bit that is always set low (stick 0 parity).
ONE	The receiver expects a parity bit. All data received has the parity checked and if it is not a logic high an error will be generated. Transmitted data includes a parity bit that is always set high (stick 1 parity).
NONE	The receiver is not expecting a parity bit included in received data and does not perform a parity check. The transmitter does not include a parity bit in the transmitted data.

Syntax

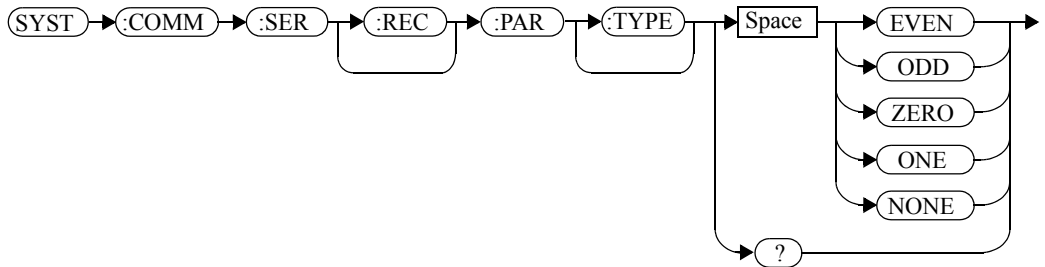

Example

```
SYST:COMM:SER:REC:PAR ODD
```

This command sets the transmitter to include an odd parity bit in the transmitted data and the receiver to check for odd parity in the received data.

Reset Condition

On reset, the parity setting is unaffected.

Query

```
SYSTem:COMMunicate:SERial[:RECeive]:PARity[:TYPE]?
```

The query returns the current setting of the receive/transmit parity type (EVEN, ODD, ZERO, ONE or NONE).

Query Example

```
SYST:COMM:SER:REC:PAR?
```

This command queries what type of parity has been set on the received/transmitted data.

SYSTem:COMMunicate:SERial[:RECeive]:SBITs <numeric_value>

This command sets the number of stop bits expected by the receiver on received data and the number of stop bits included by the transmitter in transmitted data.

Syntax

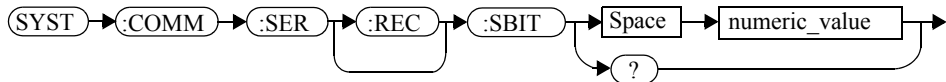

Parameters

Item	Description/Default	Range of Values
numeric_value	A numeric value for the number of stop bits.	1 or 2

Example

`SYST:COMM:SER:REC:SBIT 2` *This command sets the number of stop bits for the receiver and transmitter to 2.*

Reset Condition

On reset, the number of stop bits is unaffected.

Query

`SYSTem:COMMunicate:SERial[:RECeive]:SBITs?`

The query returns the current setting of the receive/transmit stop bits.

Query Example

`SYST:COMM:SER:REC:SBIT?` *This command queries the setting of the receive/transmit stop bits.*

SYSTem:COMMunicate:SERial:TRANsmit:AUTO?

This query always returns a 1 confirming that the transmitter parameter settings for baud rate, word length, stop bits and parity are coupled to the receiver values.

Syntax

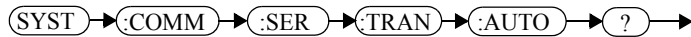

Example

SYST:COMM:SER:TRAN:AUTO?

This command always returns a 1 to show that the transmitter and receiver settings for baud rate, word length, stop bits and parity are the same.

SYSTem:COMMunicate:SERial:TRANsmit:BAUD <numeric_value>

This command sets the baud rate for both the transmitter and the receiver. The baud rate for the transmitter and receiver are tied together and can either be set by this command or the equivalent receiver command [RECEive]:BAUD.

Syntax

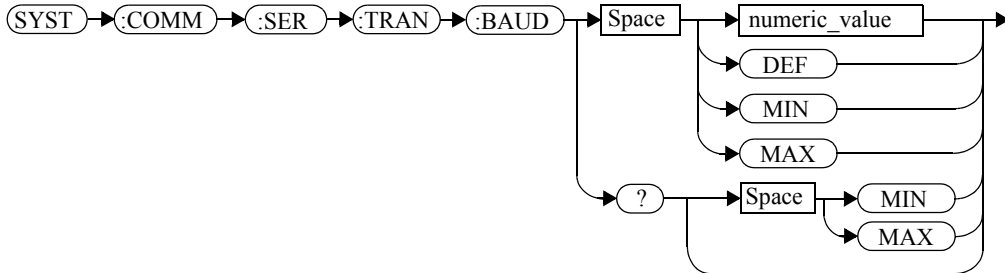

Parameters

Item	Description/Default	Range of Values
numeric_value	A numeric value for the baud rate. <ul style="list-style-type: none"> • DEF: the default value is 9600. • MIN: 50. • MAX: 115200. 	50, 75, 110, 150, 300, 1200, 1800, 2000, 2400, 3600, 4800, 7200, 9600, 19200, 38400, 57600, 115200 DEF MIN MAX

Example

SYST:COMM:SER:TRAN:BAUD 38400 *This command sets the transmitter and receiver baud rate to 38400.*

Reset Condition

On reset, the baud rate is unaffected.

Query

```
SYSTem:COMMunicate:SERial:TRANsmit:BAUD? MIN|MAX
```

The query returns the current setting of the transmit/receive baud rate or the values associated with MIN and MAX.

Query Example

```
SYST:COMM:SER:TRAN:BAUD?      This command queries the setting of the  
                                transmit/ receive baud rate.
```

Error Messages

If the baud rate is not in the range of values shown in the parameter table, then the error message -224, “Illegal parameter value” will occur.

SYSTem:COMMunicate:SERial:TRANsmit:BITs <numeric_value>

This command sets the word length for both the transmitter and the receiver. The word length for the transmitter and receiver are tied together and can either be set by this command or the equivalent receiver command [:RECEiver]:BITs.

Syntax

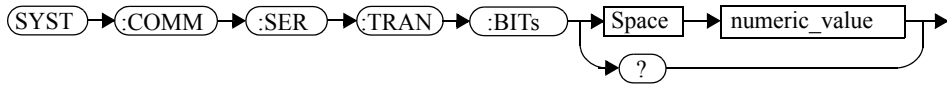

Parameters

Item	Description/Default	Range of Values
numeric_value	A numeric value for the word length	7 or 8

Example

SYST:COMM:SER:TRAN:BITs 8 *This command sets the transmitter and receiver word length to 8.*

Reset Condition

On reset, the word length is unaffected.

Query

SYSTem:COMMunicate:SERial:TRANsmit:BITs?

The query returns the current setting of the transmit/receive word length.

Query Example

SYST:COMM:SER:TRAN:BITs? *This command queries the setting of the receive/transmit word length.*

SYSTem:COMMunicate:SERial:TRANsmit:ECHO <boolean>

This command turns echo mode on and off, allowing the power meter to be controlled by a dumb terminal that may require its transmitted characters to be echoed. If ON is specified, data received by the receiver is transmitted back to the sender (echo on). If OFF is specified, data received by the receiver is not transmitted back to the sender (echo off).

Syntax

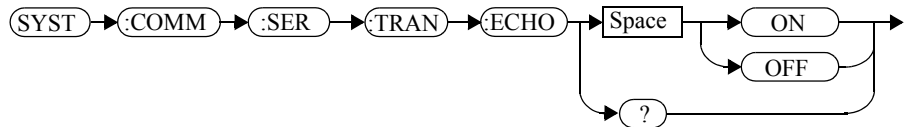

Example

`SYST:COMM:SER:TRAN:ECHO ON` *This command sets the power meter to transmit any data received back to the sender.*

Reset Condition

On reset, the echo selection is unaffected.

Query

`SYSTem:COMMunicate:SERial:TRANsmit:ECHO?`

The query returns the current setting of the transmit/receive word length.

- ON is returned if the power meter is set to return received data back to the sender (echo on).
- OFF is returned if the power meter is not set to return received data back to the sender (echo off).

Query Example

`SYST:COMM:SER:TRAN:ECHO?` *This command queries whether or not the power meter has been set to return received data back to the sender.*

SYSTEM:COMMunicate:SERial:TRANsmit:PACE XON|NONE

This command enables (XON) and disables (NONE) an Xon/Xoff software handshake for the transmitter. When enabled, if an Xoff control character is detected by the receiver, the transmitter will not transmit further characters until an Xon control character is detected by the receiver.

Syntax

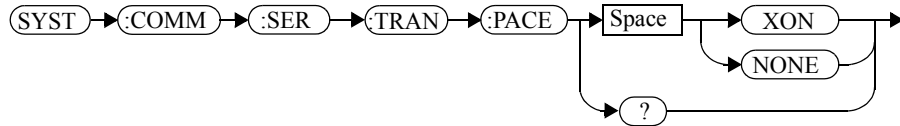

Example

```
SYST:COMM:SER:TRAN:PACE XON
```

This command enables the transmitter Xon/Xoff software handshake.

Reset Condition

On reset, pacing is unaffected.

Query

```
SYSTEM:COMMunicate:SERial:TRANsmit:PACE?
```

The query returns XON if the handshake is enabled and NONE if the handshake is disabled.

Query Example

```
SYST:COMM:SER:TRAN:PACE?
```

This command queries whether the transmitter Xon/Xoff software handshake is enabled (XON) or disabled (NONE).

SYSTem:COMMunicate:SERial:TRANsmit:PARity[:TYPE] EVEN|ODD|ZERO|ONE|NONE

This command decides what type of parity checking (if any) will take place on received data and also decides what parity (if any) will be included with transmitted data. The following choices are available and can be set using either this command or the equivalent [:RECEive]:PARity[:TYPE] command.

Parity Type	Description
EVEN	The receiver expects a parity bit. All data received is checked for even parity. An error is generated if this test fails. Transmitted data includes a parity bit set for even parity indication.
ODD	The receiver expects a parity bit. All data received is checked for odd parity. An error is generated if this test fails. Transmitted data includes a parity bit set for odd parity indication.
ZERO	The receiver expects a parity bit. All data received has the parity checked and if it is not a logic low an error will be generated. Transmitted data includes a parity bit that is always set low (stick 0 parity).
ONE	The receiver expects a parity bit. All data received has the parity checked and if it is not a logic high an error will be generated. Transmitted data includes a parity bit that is always set high (stick 1 parity).
NONE	The receiver is not expecting a parity bit included in received data and does not perform a parity check. The transmitter does not include a parity bit in the transmitted data.

Syntax

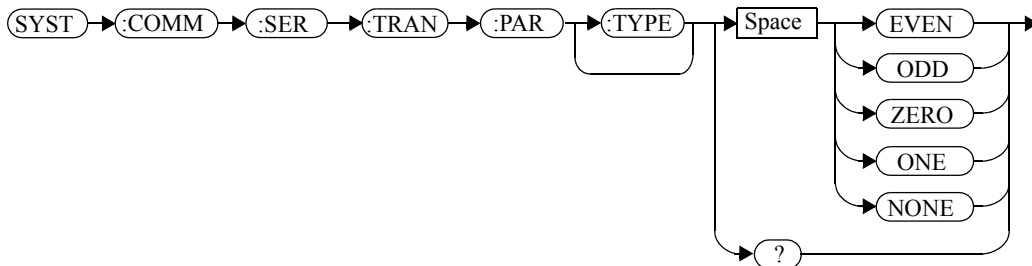

Example

SYST:COMM:SER:TRAN:PAR ODD *This command sets the transmitter to include an odd parity bit in the transmitted data and the receiver to check for odd parity in the received data.*

Reset Condition

On reset, the parity selection is unaffected.

Query

SYSTem:COMMunicate:SERial:TRANsmit:PARity[:TYPE]?

The query returns the current setting of the transmit/receive parity type (EVEN, ODD, ZERO, ONE or NONE).

Query Example

SYST:COMM:SER:TRAN:PAR? *This command queries what type of parity has been set on the transmitted/received data.*

SYSTem:COMMunicate:SERial:TRANsmit:SBITs <numeric_value>

This command sets the number of stop bits expected by the receiver on received data and the number of stop bits included by the transmitter in transmitted data.

Syntax

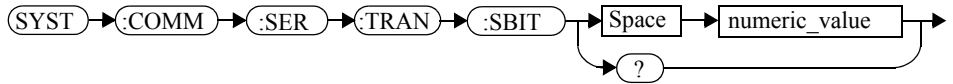

Parameters

Item	Description/Default	Range of Values
numeric_value	A numeric value for the number of stop bits.	1 or 2

Example

SYST:COMM:SER:TRAN:SBIT 2 *This command sets the number of stop bits for the transmitter and receiver to 2.*

Reset Condition

On reset, the number of stop bits is unaffected.

Query

SYSTem:COMMunicate:SERial:TRANsmit:SBITs?

The query returns the current setting of the transmit/receive stop bits.

Query Example

SYST:COMM:SER:TRAN:SBIT? *This command queries the setting of the receive/transmit stop bits.*

SYSTem:HELP:HEADers?

This query returns a list of all SCPI commands supported by the instrument.

Data is returned in IEEE 488.2 arbitrary block program data format as follows:

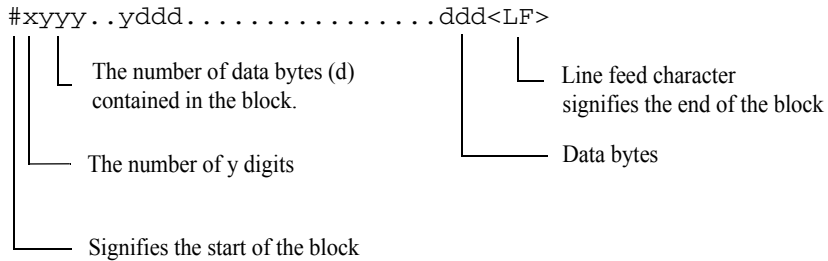

Example: if there are 12435 data bytes, $y = 12435$ and $x = 5$

Each point in the trace is represented as an IEEE 754 32 bit floating point number, made up of four bytes in the data block. The MS byte is transmitted first. Each complete block is terminated by a line feed.

Commands are listed in alphabetical order.

Syntax

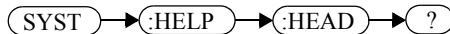

Example

SYST:HELP:HEAD?

This command returns the SCPI commands supported by the instrument.

SYSTem:LOCal

This command unlocks the front panel keypad and enables the power meter to be controlled locally from the front panel. The power meter display status reporting line will show “LCL”.

Syntax

(SYST) → (:LOC) →

Example

SYST:LOC

This command unlocks the power meter front panel keypad and enables local front panel control.

Error Messages

If this command is sent when the GPIB interface is selected, the error -113, “Undefined header” occurs.

SYSTem:PRESet <character_data>

This command presets the power meter to values appropriate for measuring the communications format specified by <character_data>. The power meter is preset to default values if no value or if the value DEFault is supplied.

Note DEFault settings apply to both *RST and to
 SYSTem:PRESet DEFault unless stated otherwise.

For further information on preset configurations, refer to
Tables 11-1 to 11-25.

Command results differ according to the sensor(s) connected to the power meter:

- If both an E9320 sensor and non-E9320 sensor are connected to a dual channel power meter, the channel connected to the E9320 sensor is set up according to the <character_data> value and the non-E9320 channel is set to DEFault values.
- If two E9320 sensors are connected to a dual channel power meter, both channels are set to the same values except for bandwidth which is set to an appropriate value for each sensor.

Primary and secondary channels

Dual channel meter channels are defined as either primary or secondary. The primary channel is always the trigger master and primary channel measurements occupy a greater share of the display space than secondary channel measurements.

- If a dual channel meter has one E9320 sensor connected, the E9320 sensor channel is the primary channel. In such cases the primary channel could be either channel A or channel B. The non-E9320 channel is the secondary channel.
- If a dual channel meter has two E9320 sensors connected to it, the primary channel is always channel A and the secondary channel is channel B.

Syntax

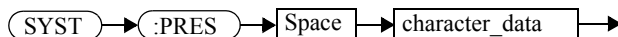

Parameters

Item	Description/Default	Range of Values
character_data	A communications format which determines the preset values. Refer to Tables 11.1 to 11.25 for the preset values for each format.	Default GSM900 EDGE NADC BLUetooth CDMAone WCDMA CDMA2000 IDEN

Example

SYST:PRESet DEF

This command presets the power meter with default values. The same default values are set when the parameter is omitted.

Error messages

- If a non-E-Series power sensor or N8480 Series power sensor with Option CFT is connected, the command can be used to set the power meter to Default settings. When non-of the connected sensors is E9320 sensor, attempts to set the power meter to any of the other settings result in error -241 “Hardware missing: E9320 Series sensor required” occurring.
- If BLUetooth or CDMAone is selected and an E9322/6A (1.5 MHz bandwidth) or E9323/7A (5 MHz bandwidth) power sensor is not connected, error -241 “Hardware missing: Higher bandwidth E9320 sensor required on channel X. Measurements on channel X may be inaccurate” occurs.
- If WCDMA or CDMA2000 is selected and an E9323/7A (5 MHz bandwidth) power sensor is not connected, error -241 “Hardware missing: Higher bandwidth E9320 sensor required on channel X. Measurements on channel X may be inaccurate” occurs.
- If two E9320 power sensors are connected to a dual channel power meter and only one is of sufficient bandwidth to support the selected format, error -241 “Hardware missing: Higher bandwidth E9320 sensor required on channel X. Measurements on channel X may be inaccurate” occurs.

Preset Values

DEFAult

The following table shows the power meter presets when <character_data> is set to DEFAult or omitted. Values are shown for all SCPI commands:

Table 0-1: DEFAult: Power Meter Presets

Command	Setting	Comments
CALC[1] 2 3 4:FEED[1] 2	"POW:AVER"	Select average measurement type
CALC[1] 2 3 4:GAIN[:MAGN]	0.000 dB	Display offset value
CALC[1] 2 3 4:GAIN:STAT	OFF	Display offset disabled
CALC[1] 2 3 4:LIM:CLE:AUTO	ON	Clear limit data at INIT
CALC[1] 2 3 4:LIM:LOW[:DATA]	-90 dBm	Lower limit
CALC[1] 2 3 4:LIM:STAT	OFF	Window limits checking disabled
CALC[1] 2 3 4:LIM:UPP[:DATA]	+90 dBm	
CALC[1] 2 3 4:MATH[:EXPR]	Agilent E4416A: Upper - channel A Lower - channel A Agilent E4417A Upper - channel A Lower - channel B	Math expression
CALC[1] 2 3 4:REL[:MAGN]:AUTO	OFF	Reference value disabled
CALC[1] 2 3 4:REL:STAT	OFF	Relative offset disabled
CAL[1] 2:ECON:STAT	OFF	TTL zero/calibration inputs disabled
CAL[1] 2:RCAL	not affected	zero/cal lockout
CAL[1] 2:RCF	100.0%	Reference calibration factor
DISP:CONT	not affected	Display contrast
DISP:ENAB	ON	Display enabled
DISP:SCR:FORM	WIND	Display format set to windowed
DISP[:WIND[1] 2]:ANAL:LOW	-70 dBm	Lower scale limit
DISP[:WIND[1] 2]:ANAL:UPP	20 dBm	Upper scale limit

Command	Setting	Comments
DISP[:WIND[1] 2]:FORM	Agilent E4416A: Upper - digital Lower - analog Agilent E4417A Upper - digital Lower - digital	Display format
DISP[:WIND[1] 2]:MET:LOW	-70.000 dBm	Analog meter lower limit
DISP[:WIND[1] 2]:MET:UPP	+20.000 dBm	Analog meter upper limit
DISP[:WIND[1] 2][[:NUM[1] 2]:RES	3	Window resolution
DISP[:WIND[1] 2]:SEL[1] 2	upper window	Window selected
DISP[:WIND[1] 2][[:STAT]	ON	Both windows enabled on display
DISP[:WIND[1] 2]:TRAC:LOW	DEF	Maximum power
DISP[:WIND[1] 2]:TRAC:UPP	DEF	Minimum power
FORM[:READ]:BORD	normal	Binary order
FORM[:READ][[:DATA]	ascii	Data format
INIT[1] 2:CONT	*RST: OFF SYS:PRES ON	Power Meter in idle state Power Meter in wait for trigger state
MEM:TABL:SEL	not affected	Active sensor calibration table
OUTP:REC[1] 2:FEED	not affected	Previous measurement
OUTP:REC[1] 2:LIM:LOW	-150 dBm	Minimum scaling value
OUTP:REC[1] 2:LIM:UPP	20 dBm	Maximum scaling value
OUTP:ROSC:STAT	OFF	50 MHz reference disabled
OUTP:TRIG:STAT	OFF	Trigger output signal disabled
OUTP:TTL[1] 2:ACT	LOW	TTL output active low
OUTP:TTL[1] 2:FEED	"CALC[1] 2 3 4:LIM:UPP"	TTL output represents upper limit fail
OUTP:TTL[1] 2:STAT	OFF	TTL output is disabled
[SENS[1] SENS2:AVER:COUN	4	Filter length
[SENS[1] SENS2:AVER:COUN:AUTO	ON	Auto-filtering enabled
[SENS[1] SENS2:AVER:SDET	1	Step detection enabled
[SENS[1] SENS2:AVER[:STAT]	ON	Averaging enabled
[SENS[1] SENS2:AVER2:COUN	4	Video average length
[SENS[1] SENS2:AVER2[:STAT]	ON	Video averaging enabled

SYSTEM Subsystem
SYSTEM:PRESet <character_data>

Command	Setting	Comments
[SENS[1]] SENS2:BAND BWID:VID	OFF	Sensor video bandwidth set to off
[SENS[1]] SENS2:CORR:CFAC GAIN[1] [:INPut] [:MAGNitude]	100.0%	Calibration factor
[SENS[1]] SENS2:CORR:CSET[1] CSET2[:SEL]	not affected	Selected sensor calibration table
[SENS[1]] SENS2:CORR:CSET[1] CSET2:STAT	not affected	Sensor calibration table disabled
[SENS[1]] SENS2:CORR:DCYC GAIN3 [:INP] [:MAGN]	1.000%	Duty cycle factor
[SENS[1]] SENS2:CORR:DCYC GAIN3 :STAT	OFF	Duty cycle correction disabled
[SENS[1]] SENS2:CORR:FDOF GAIN4 [:INP] [:MAGN]	not affected	Return frequency dependent offset
[SENS[1]] SENS2:CORR:GAIN2:STAT	OFF	Channel offset disabled
[SENS[1]] SENS2:CORR:GAIN2:STAT [:INPut] [:MAGNitude]	0.0 dB	Enter channel offset value
[SENS[1]] SENS2:DET:FUNC	NORM	Measurement mode
[SENS[1]] SENS2:FREQ[:CW] [:FIX]	+50.000 MHz	Frequency setting
[SENSe[1]] SENS2:MRAT	NORM	Measurement speed
[SENS[1]] SENS2:POW:AC:RANG	upper	Upper range selected
[SENS[1]] SENS2:POW:AC:RANG: AUTO	ON	Auto-ranging selected
[SENS[1]] SENS2:SPE	20 readings/ second	Speed
[SENS[1]] SENS2:SWE[1] 2 3 4 :OFFS:TIME	0	Set delay
[SENS[1]] SENS2:SWE[1] 2 3 4 :TIME	Gate 1: 100 us Other gates: 0 sec	Set time gated period
[SENS[1]] SENS2:TRACe:OFFSet: TIME	0	Delay
[SENS[1]] SENS2:TRACe:TIME	100 us	Duration of trace
[SENS[1]] SENS2:V2P	ATYP	Select linearity correction
SYST:GPIB[:SEL] ADDR	not affected	Power meter address
SYST:COMM:SER:CONT:DTR	not affected	DTR signal line
SYST:COMM:SER:CONT:RTS	not affected	RTS signal line
SYST:COMM:SER[:REC]:BAUD	not affected	Baud rate
SYST:COMM:SER[:REC]:BITS	not affected	Word length

Command	Setting	Comments
SYST:COMM:SER[:REC]:PACE	not affected	Xon/Xoff software handshake
SYST:COMM:SER[:REC]: PAR[:TYPE]	not affected	Parity setting
SYST:COMM:SER[:REC]:SBIT	not affected	Number of stop bits
SYST:COMM:SER:TRAN:BAUD	not affected	Baud rate
SYST:COMM:SER:TRAN:BITS	not affected	Word length
SYST:COMM:SER:TRAN:ECHO	not affected	Dumb terminal control
SYST:COMM:SER:TRAN:PACE	not affected	Xon/Xoff software handshake
SYST:COMM:SER:TRAN: PAR[:TYPE]	not affected	Parity setting
SYST:COMM:SER:TRAN:SBIT	not affected	Number of stop bits
TRAC[1] 2:STAT	OFF	Disable trace capture
TRAC[1] 2:UNIT	dBm	Trace units
TRIG[1] 2:DEL:AUTO	ON	Insert settling time delay
TRIG[:SEQ]:DEL	0	Delay between recognition of trigger event and start of a measurement
TRIG[:SEQ]:HOLD	1 us	Trigger holdoff
TRIG[:SEQ]:HYST	0 db	Fall/rise below/above TRIG:LEV
TRIG[:SEQ]:LEV	0 db	Power level
TRIG[:SEQ]:LEV:AUTO	ON	Enable automatic setting of trigger level
TRIG[:SEQ]:SLOP	POS	Trigger event recognized on rising edge
TRIG[:SEQ[1] 2]:COUN	1	Trigger events for measurement cycle
TRIG[:SEQ[1] 2]:DEL:AUTO	ON	Enable settling time delay
TRIG[:SEQ[1] 2]:SOUR	IMM	Trigger source set up
UNIT:POW	dBm	Power units
UNIT:POW:RAT	dB	Ratio units

GSM900

The following table shows the power meter presets when <character_data> is set to GSM900.

The GSM900 set-up provides the following:

- Average power measurement in one GSM timeslot.
- Trace display showing “on” timeslot.

A GSM900 measurement is started by detecting the rising edge of a GSM RF burst—for example the burst emitted by a GSM mobile—using the internal RF level trigger. The trigger level is set to -20dBm. Time-gating is used to measure the average power in the useful part of a GSM burst.

Commands not listed are preset according to their DEFault values (for further information refer to Table 11-1).

Table 0-2: GSM900: Power Meter Presets

Command	Setting	Comments
<i>Frequency</i>		
[SENS[1]] SENS2:FREQ[:CW :FIX]	+900.000 MHz	Frequency setting
<i>Sensor measurement mode</i>		
[SENS[1]] SENS2:DET:FUNC	NORM	Measurement mode
<i>Sensor video bandwidth setup</i>		
[SENS[1]] SENS2:BAND BWID:VID	E9321A/25A: HIGH E9322A/26A: MED E9323A/27A: LOW	Sensor video bandwidth
<i>Gate setup</i>		
[SENS[1]] SENS2:SWE[1] 2 3 4 :OFF:TIME	Gate 1: 20 us Gates 2 - 4: 0	Delay between trigger point and time gated period.
[SENS[1]] SENS2:SWE[1] 2 3 4 :TIME	Gate 1: 520 us Gates 2 - 4: 0	Length of time gated period for time gated measurements.
<i>Trigger setup</i>		
TRIG[:SEQ[1] 2]:SOUR	INT1	Trigger source set up and acquisition mode continuous triggering
INIT:CONT	ON	
TRIG[:SEQ]:LEV:AUTO	OFF	Disable automatic setting of the trigger level
TRIG[:SEQ]:LEV	-20 dBm	Power level
TRIG[:SEQ]:SLOP	POS	Trigger event recognized on the rising edge of a signal

Command	Setting	Comments
TRIG[:SEQ]:DEL	20 us	Delay between recognition of trigger event and start of a measurement
TRIG[:SEQ]:HOLD	4275 us	Trigger holdoff
<i>Step detection</i>		
[SENSe[1]] SENS2:AVER:SDET	1	Step detection enabled
<i>Trace setup</i>		
DISP[:WIND[1] 2]:TRAC:LOW	+20 dBm	Maximum power
DISP[:WIND[1] 2]:TRAC:UPP	-35 dBm	Minimum power
[SENS[1]] SENS2:TRAC:OFFS:TIME <numeric_value>	-40 us	Delay between delayed trigger point and the start of the trace
[SENS[1]] SENS2:TRAC:TIME <numeric_value>	700 us	Length of the trace

Table 0-3: GSM900: Power Meter Presets: Window/Measurement Settings

Function	Setting	
	No Sensor	Non E9320 Sensor
<i>Display setup</i>		
Upper window	Channel A trace	Primary channel ¹ trace
Lower window	LU single numeric	See Table 0-4
<i>Window/measurement setup</i>		
<i>Upper window/upper measurement (UU)</i>		
Feed	N/A	N/A
Measurement	N/A	N/A
<i>Upper window/lower measurement (UL)</i>		
Feed	N/A	N/A
Measurement	N/A	N/A
<i>Lower window/upper measurement (LU)</i>		
Feed	Gate 1 Channel A	Gate 1 primary channel ¹
Measurement	Avg	Avg
<i>Lower window/lower measurement (LL)</i>		
Feed	DEF	See Table 0-4
Measurement	DEF	See Table 0-4

1. For further information refer to “Primary and secondary channels”, on page 11-28.

Table 0-4: GSM900: Power Meter Presets For Secondary Channel Sensors

Function	Secondary Channel Sensor		
	No Sensor	Non E9320 Sensor	E9320 Sensor
<i>Display setup</i>			
Lower window	LU single numeric	Dual numeric	Dual numeric
<i>Lower window/lower measurement (LL)</i>			
Feed	DEF	Secondary channel ¹	Gate1 secondary channel ¹ (channel B)
Measurement	DEF	Avg	Avg

1. For further information refer to “Primary and secondary channels”, on page 11-28.

EDGE

EDGE (Enhanced Data for Global Evolution or Enhanced Data for GSM Evolution) is an enhancement of the GSM standard. Whereas the GSM modulation scheme is GMSK which has constant amplitude, the EDGE modulation scheme is 8PSK which has variable amplitude.

The EDGE set-up provides:

- Average power measurement in an EDGE burst.
- Peak-to-average ratio in an EDGE burst.
- A trace display of the burst profile

An EDGE measurement is started by detecting the rising edge of the EDGE RF burst—for example the burst emitted by a mobile—using the internal RF level trigger. The internal level trigger is set to -20dBm . Trigger level hysteresis is used to prevent the power meter re-triggering on the varying power levels within the EDGE burst. Time-gating is used to measure the average power and the peak-to-average ratio in the useful part of the RF burst.

The following table shows the power meter presets when <character_data> is set to EDGE. Commands not listed are preset according to their DEFault values (for further information refer to Table 11-1).

Table 0-5: EDGE: Power Meter Presets

Command	Setting	Comments
<i>Frequency</i>		
[SENS[1]] SENS2:FREQ[:CW :FIX]	+900.000 MHz	Frequency setting
<i>Sensor measurement mode</i>		
[SENS[1]] SENS2:DET:FUNC	NORM	Measurement mode
<i>Sensor video bandwidth setup</i>		
[SENS[1]] SENS2:BAND BWID:VID	E9321A/25A: HIGH E9322A/26A: MED E9323A/27A: LOW	Sensor video bandwidth
<i>Gate setup</i>		
[SENS[1]] SENS2:SWE[1] 2 3 4 :OFF:TIME	Gate 1: 20 us Gates 2 - 4: 0	Delay between trigger point and time gated period.
[SENS[1]] SENS2:SWE[1] 2 3 4 :TIME	Gate 1: 520 us Gates 2 - 4: 0	Length of time gated period for time gated measurements
<i>Trigger setup</i>		
TRIGger[:SEQuence[1] 2]:SOUR	INT1	Trigger source setup and acquisition mode continuous triggering
INIT:CONT	ON	
TRIG[:SEQ]:LEV:AUTO	OFF	Disable automatic setting of the trigger level
TRIG[:SEQ]:LEV	-20 dBm	Power level
TRIG[:SEQ]:SLOP	POS	Trigger event recognized on the rising edge of a signal
TRIG[:SEQ]:DEL	0	Delay between recognition of trigger event and start of a measurement
TRIG[:SEQ]:HOLD	4275 us	Trigger holdoff
<i>Step detection</i>		
[SENSe[1]] SENS2:AVER:SDET	1	Step detection enabled
<i>Trace setup</i>		
DISP[:WIND[1] 2]:TRAC:LOW	+20 dBm	Maximum power
DISP[:WIND[1] 2]:TRAC:UPP	-35 dBm	Minimum power
[SENS[1]] SENS2:TRAC:OFFS :TIME <numeric_value>	-40 us	Delay between delayed trigger point and the start of the trace
[SENS[1]] SENS2:TRAC:TIME <numeric_value>	700 us	Length of the trace

Table 0-6: EDGE: Power Meter Presets: Window/Measurement Settings

Function	Setting	
	No Sensor	Non E9320 Sensor
<i>Display setup</i>		
Upper window	Channel A trace	Primary channel ¹ trace
Lower window	Dual numeric	See Table 0-7
<i>Window/measurement setup</i>		
<i>Upper window/upper measurement (UU)</i>		
Feed	N/A	N/A
Measurement	N/A	N/A
<i>Upper window/lower measurement (UL)</i>		
Feed	N/A	N/A
Measurement	N/A	N/A
<i>Lower window/upper measurement (LU)</i>		
Feed	Gate 1 Channel A	Gate 1 primary channel ¹
Measurement	Avg	Avg
<i>Lower window/lower measurement (LL)</i>		
Feed	Gate 1 Channel A	See Table 0-7
Measurement	Peak to avg	See Table 0-7

1. For further information refer to “Primary and secondary channels”, on page 11-28.

Table 0-7: EDGE: Power Meter Presets For Secondary Channel Sensors

Function	Secondary Channel Sensor		
	No Sensor	Non E9320 Sensor	E9320 Sensor
<i>Display setup</i>			
Lower window	Dual numeric	Dual numeric	Dual numeric
<i>Lower window/lower measurement (LL)</i>			
Feed	Gate 1 primary channel ¹	Secondary channel ¹	Gate1 secondary channel ¹ (channel B)
Measurement	Peak to avg	Avg	Avg

1. For further information refer to “Primary and secondary channels”, on page 11-28.

NADC

The NADC set-up provides:

- Average power measurement of both active timeslots in NADC or IS-136 “full rate” transmission. This assumes that there are two timeslots to be measured in each frame as for example with timeslots 0 in the following diagram:

Figure 0-1: A Trace Display Of The Active Timeslots

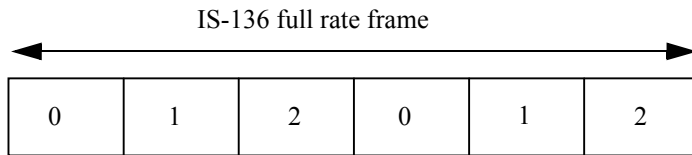

- A trace display of the active timeslots.

The measurement is started by detecting the RF burst—for example the burst emitted by a mobile—using the internal RF level trigger. The internal level trigger is set to -20dBm. Time-gating is used to measure the average power in two active timeslots which are separated by two inactive timeslots

The following table shows the power meter presets when <character_data> is set to NADC. Commands not listed are preset according to their DEFault values (for further information refer to Table 11-1):

Table 0-8: NADC: Power Meter Presets

Command	Setting	Comments
<i>Frequency</i>		
[SENS [1]] SENS2 : FREQ [: CW : FIX]	+800.000 MHz	Frequency setting
<i>Sensor measurement mode</i>		
[SENS [1]] SENS2 : DET : FUNC	NORM	Measurement mode
<i>Sensor video bandwidth setup</i>		
[SENS [1]] SENS2 : BAND BWID : VID	E9321A/25A: OFF E9322A/26A: OFF E9323A/27A: OFF	Sensor video bandwidth
<i>Gate setup</i>		

Command	Setting	Comments
[SENS[1]] SENS2:SWE[1] 2 3 4 :OFF:TIME	Gate 1: 123.5 us Gate 2: 20.123 ms Gates 3 - 4: 0	Delay between trigger point and time gated period.
[SENS[1]] SENS2:SWE[1] 2 3 4 :TIME	Gates 1 - 2: 6.46 ms Gates 3 - 4: 0	Length of time gated period for time gated measurements.
<i>Trigger setup</i>		
TRIG[:SEQ][1] 2]:SOUR	INT1	Trigger source set up and acquisition mode continuous triggering
INIT:CONT	ON	
TRIG[:SEQ]:LEV:AUTO	OFF	Disable automatic setting of the trigger level
TRIG[:SEQ]:LEV	-20 dBm	Power level
TRIG[:SEQ]:SLOP	POS	Trigger event recognized on the rising edge of a signal
TRIG[:SEQ]:DEL	0	Delay between recognition of trigger event and start of a measurement
TRIG[:SEQ]:HOLD	30 ms	Trigger holdoff
<i>Step detection</i>		
[SENS[1]] SENS2:AVER:SDET	0	Step detection disabled
<i>Trace setup</i>		
DISP[:WIND[1] 2]:TRAC:LOW	+20 dBm	Maximum power
DISP[:WIND[1] 2]:TRAC:UPP	-35 dBm	Minimum power
[SENS[1]] SENS2:TRAC:OFFS :TIME <numeric_value>	-0.2 ms	Delay between delayed trigger point and the start of the trace
[SENS[1]] SENS2:TRAC:TIME <numeric_value>	-28 ms	Length of the trace

Table 0-9: NADC: Power Meter Presets: Window/Measurement Settings

Function	Setting	
	No Sensor	Non E9320 Sensor
<i>Display setup</i>		
Upper window	Channel A trace	Primary channel ¹ trace
Lower window	Dual numeric	See Table 0-10
<i>Window/measurement setup</i>		
<i>Upper window/upper measurement (UU)</i>		
Feed	N/A	N/A
Measurement	N/A	N/A
<i>Upper window/lower measurement (UL)</i>		
Feed	N/A	N/A
Measurement	N/A	N/A
<i>Lower window/upper measurement (LU)</i>		
Feed	Gate 1 Channel A	Gate 1 primary channel ¹
Measurement	Avg	Avg
<i>Lower window/lower measurement (LL)</i>		
Feed	Gate 2 Channel A	See Table 0-10
Measurement	Avg	See Table 0-10

1. For further information refer to “Primary and secondary channels”, on page 11-28.

Table 0-10: NADC: Power Meter Presets For Secondary Channel Sensors

Function	Secondary Channel Sensor		
	No Sensor	Non E9320 Sensor	E9320 Sensor
<i>Display setup</i>			
Lower window	Dual numeric	Dual numeric	Dual numeric
<i>Lower window/lower measurement (LL)</i>			
Feed	Gate 2 primary channel ¹	Secondary channel ¹	Gate1 secondary channel ¹ (channel B)
Measurement	Avg	Avg	Avg

1. For further information refer to “Primary and secondary channels”, on page 11-28.

BLUetooth

The Bluetooth set-up provides:

- Average power in a Bluetooth DHI data burst.
- Peak power in the same burst.
- Display of RF pulse in one timeslot.

The measurement is started by detecting the Bluetooth RF burst using the internal RF level trigger. The internal trigger is set to -20dBm . Time-gating is used to measure the peak and average power in a single Bluetooth DHI data burst which lasts for $366\mu\text{s}$. The DHI burst does not occupy a full Bluetooth timeslot, which lasts for $625\mu\text{s}$.

The following table shows the power meter presets when <character_data> is set to BLUetooth. Commands not listed are preset according to their DEFault values (for further information refer to Table 11-1):

Table 0-11: BLUetooth: Power Meter Presets

Command	Setting	Comments
<i>Frequency</i>		
[SENS[1]] SENS2:FREQ[:CW :FIX]	+2400.000 MHz	Frequency setting
<i>Sensor measurement mode</i>		
[SENS[1]] SENS2:DET:FUNC	NORM	Measurement mode
<i>Sensor video bandwidth setup</i>		
[SENS[1]] SENS2:BAND BWID:VID	E9321A/25A: DEF E9322A/26A: HIGH E9323A/27A: MEDium	Sensor video bandwidth
<i>Gate setup</i>		
[SENS[1]] SENS2:SWE[1] 2 3 4 :OFF:TIME	Gate 1: 0.2 us Gates 2 - 4: 0	Delay between trigger point and time gated period.
[SENS[1]] SENS2:SWE[1] 2 3 4 :TIME	Gate 1: 366 us Gates 2 - 4: 0	Length of time gated period for time gated measurements.
<i>Trigger setup</i>		
TRIGger[:SEQuence[1] 2]:SOUR	INT1	Trigger source set up and acquisition mode continuous triggering
INIT:CONT	ON	
TRIG[:SEQ]:LEV:AUTO	OFF	Disable automatic setting of the trigger level
TRIG[:SEQ]:LEV	-20 dBm	Power level
TRIG[:SEQ]:SLOP	POS	Trigger event recognized on the rising edge of a signal
TRIG[:SEQ]:DEL	0	Delay between recognition of trigger event and start of a measurement
TRIG[:SEQ]:HOLD	650 us	Trigger holdoff
<i>Step detection</i>		
[SENSe[1]] SENS2:AVER:SDET	1	Step detection enabled
<i>Trace setup</i>		
DISP[:WIND[1] 2]:TRAC:LOW	+20 dBm	Maximum power
DISP[:WIND[1] 2]:TRAC:UPP	-35 dBm	Minimum power
[SENS[1]] SENS2:TRAC:OFF :TIME <numeric_value>	-50 us	Delay between delayed trigger point and the start of the trace
[SENS[1]] SENS2:TRAC:TIME <numeric_value>	3.8 ms	Length of the trace

Table 0-12: BLUetooth: Power Meter Presets: Window/Measurement Settings

Function	Setting	
	No Sensor	Non E9320 Sensor
<i>Display setup</i>		
Upper window	Channel A trace	Primary channel ¹ trace
Lower window	Dual numeric	See Table 0-13
<i>Window/measurement setup</i>		
<i>Upper window/upper measurement (UU)</i>		
Feed	N/A	N/A
Measurement	N/A	N/A
<i>Upper window/lower measurement (UL)</i>		
Feed	N/A	N/A
Measurement	N/A	N/A
<i>Lower window/upper measurement (LU)</i>		
Feed	Gate 1 Channel A	Gate 1 primary channel ¹
Measurement	Avg	Avg
<i>Lower window/lower measurement (LL)</i>		
Feed	Gate 1 Channel A	See Table 0-13
Measurement	Peak	See Table 0-13

1. For further information refer to “Primary and secondary channels”, on page 11-28.

Table 0-13: BLUetooth: Power Meter Presets For Secondary Channel Sensors

Function	Secondary Channel Sensor		
	No Sensor	Non E9320 Sensor	E9320 Sensor
<i>Display setup</i>			
Lower window	Dual numeric	Dual numeric	Dual numeric
<i>Lower window/lower measurement (LL)</i>			
Feed	Gate 1 primary channel ¹	Secondary channel ¹	Gate1 secondary channel ¹ (channel B)
Measurement	Peak	Avg	Avg

1. For further information refer to “Primary and secondary channels”, on page 11-28.

CDMAone

The cdmaOne set-up provides:

- Average power in an IS-95 cdmaOne signal (bandwidth is less than 1.5MHz).
- Peak power and peak-to-average ratio of the signal over a defined, statistically valid number of samples. The reading is continuously refreshed. This gives an indication of how cdmaOne channel loading affects peak power and power distribution.

The measurement is a continuously gated measurement on a cdmaOne signal. Its aim is to measure the peak and average power corresponding to a <0.01% probability that there are no peaks above the returned peak reading. Time gating is therefore set to 10ms, corresponding to 200000 samples. Triggering is set to occur continuously internally to the meter. The internal trigger is set to AutoLevel. A reading over the 10ms period is returned and the reading is then re-initiated for the next 10ms period. In this way the reading always relates to a position beyond 0.01% on the CCDF curve and will refresh to track any signal or DUT changes.

The following table shows the power meter presets when <character_data> is set to CDMAone. Commands not listed are preset according to their DEFault values (for further information refer to Table 11-1):

Table 0-14: CDMAone: Power Meter Presets

Command	Setting	Comments
<i>Frequency</i>		
[SENS[1]] SENS2:FREQ[:CW :FIX]	+850.000 MHz	Frequency setting
<i>Sensor measurement mode</i>		
[SENS[1]] SENS2:DET:FUNC	NORM	Measurement mode
<i>Sensor video bandwidth setup</i>		
[SENS[1]] SENS2:BAND BWID:VID	E9321A/25A: DEF E9322A/26A: HIGH E9323A/27A: MEDium	Sensor video bandwidth
<i>Gate setup</i>		
[SENS[1]] SENS2:SWE[1] 2 3 4 :OFF:TIME	Gates 1 - 4: 0	Delay between trigger point and time gated period.
[SENS[1]] SENS2:SWE[1] 2 3 4 :TIME	Gate 1: 10 ms Gates 2 - 4: 0	Length of time gated period for time gated measurements.
<i>Trigger setup</i>		

Command	Setting	Comments
TRIGger [:SEQuence[1] 2] :SOUR	INT1	Trigger source set up and acquisition mode continuous triggering
INIT:CONT	ON	
TRIG[:SEQ]:LEV:AUTO	ON	Enable automatic setting of the trigger level
TRIG[:SEQ]:LEV	Automatically determined by power meter	Power level
TRIG[:SEQ]:SLOP	POS	Trigger event recognized on the rising edge of a signal
TRIG[:SEQ]:DEL	0	Delay between recognition of trigger event and start of a measurement
TRIG[:SEQ]:HOLD	MIN	Trigger holdoff
<i>Step detection</i>		
[SENSe[1]] SENS2:AVER:SDET	0	Step detection disabled

Table 0-15: CDMAone: Power Meter Presets: Window/Measurement Settings

Function	Setting	
	No Sensor	Non E9320 Sensor
<i>Display setup</i>		
Upper window	UU single numeric	See Table 0-16
Lower window	Dual numeric	See Table 0-16
<i>Window/measurement setup</i>		
<i>Upper window/upper measurement (UU)</i>		
Feed	Gate 1 channel A	Gate 1 primary channel ¹
Measurement	Avg	Avg
<i>Upper window/lower measurement (UL)</i>		
Feed	DEF	See Table 0-16
Measurement	DEF	See Table 0-16
<i>Lower window/upper measurement (LU)</i>		
Feed	Gate 1 Channel A	See Table 0-16
Measurement	Peak	See Table 0-16
<i>Lower window/lower measurement (LL)</i>		
Feed	Gate 1 Channel A	See Table 0-16

Function	Setting	
	No Sensor	Non E9320 Sensor
Measurement	Peak to avg	See Table 0-16

1. For further information refer to “Primary and secondary channels”, on page 11-28.

Table 0-16: CDMAone: Power Meter Presets For Secondary Channel Sensors

Function	Secondary Channel Sensor		
	No Sensor	Non E9320 Sensor	E9320 Sensor
<i>Display setup</i>			
Upper window	UU single numeric	Dual numeric	Dual numeric
Lower window	Dual numeric	Dual numeric	Dual numeric
<i>Upper window/lower measurement (UL)</i>			
Feed	DEF	Gate 1 primary channel ¹	Gate 1 primary channel ¹ (channel A)
Measurement	DEF	Peak	Peak
<i>Lower window/upper measurement (LU)</i>			
Feed	Gate 1 primary channel ¹	Gate 1 primary channel ¹	Gate 1 secondary channel ¹ (channel B)
Measurement	Peak	Peak to avg	Avg
<i>Lower window/lower measurement (LL)</i>			
Feed	Gate 1 primary channel ¹	Secondary channel ¹	Gate1 secondary channel ¹ (channel B)
Measurement	Peak to avg	Avg	Peak to avg

1. For further information refer to “Primary and secondary channels”, on page 11-28.

WCDMA

The W-CDMA set-up provides:

- Average power in a W-CDMA signal (bandwidth <=5MHz)
- Peak power and peak-to-average ratio of the signal over a defined, statistically valid number of samples. The reading is continuously refreshed. This indicates how W-CDMA channel loading affects peak power and power distribution.

The measurement is a continuously gated measurement on a 3GPP W-CDMA signal. Its aim is to measure the peak and average power corresponding to a <0.01% probability that there are no peaks above the returned peak reading. Time gating is set to 10ms, corresponding to 200000 samples. Triggering is set to occur continuously internally to the meter. The internal trigger is set to AutoLevel. A reading over the 10ms period is returned then re-initiated for the next 10ms period. In this way the reading always relates to a position beyond 0.01% on the CCDF curve and will refresh to track any signal or DUT changes.

The following table shows the power meter presets when <character_data> is set to WCDMA. Commands not listed are preset according to their DEFault values (for further information refer to

Table 11-1):

Table 0-17: WCDMA: Power Meter Presets

Command	Setting	Comments
<i>Frequency</i>		
[SENS[1]] SENS2:FREQ[:CW :FIX]	+1900.000 MHz	Frequency setting
<i>Sensor measurement mode</i>		
[SENS[1]] SENS2:DET:FUNC	NORM	Measurement mode
<i>Sensor video bandwidth setup</i>		
[SENS[1]] SENS2:BAND BWID:VID	E9321A/25A: DEF E9322A/26A: DEF E9323A/27A: HIGH	Sensor video bandwidth
<i>Gate setup</i>		
[SENS[1]] SENS2:SWE[1] 2 3 4 :OFF:TIME	Gates 1 -4: 0	Delay between trigger point and time gated period.
[SENS[1]] SENS2:SWE[1] 2 3 4 :TIME	Gate 1: 10 ms Gates 2 - 4: 0	Length of time gated period for time gated measurements.
<i>Trigger setup</i>		

Command	Setting	Comments
TRIGger [:SEQuence [1] 2] :SOUR	INT1	Trigger source set up and acquisition mode continuous triggering
INIT:CONT	ON	
TRIG [:SEQ] :LEV:AUTO	ON	Enable automatic setting of the trigger level
TRIG [:SEQ] :LEV	Automatically determined by power meter	Power level
TRIG [:SEQ] :SLOP	POS	Trigger event recognized on the rising edge of a signal
TRIG [:SEQ] :DEL	0	Delay between recognition of trigger event and start of a measurement
TRIG [:SEQ] :HOLD	MIN	Trigger holdoff
<i>Step detection</i>		
[SENSE [1]] SENS2 : AVER : SDET	0	Step detection enabled

Table 0-18: WCDMA: Power Meter Presets: Window/Measurement Settings

Function	Setting	
	No Sensor	Non E9320 Sensor
<i>Display setup</i>		
Upper window	UU single numeric	See Table 0-19
Lower window	Dual numeric	See Table 0-19
<i>Window/measurement setup</i>		
<i>Upper window/upper measurement (UU)</i>		
Feed	Gate 1 channel A	Gate 1 primary channel ¹
Measurement	Avg	Avg
<i>Upper window/lower measurement (UL)</i>		
Feed	DEF	See Table 0-19
Measurement	DEF	See Table 0-19
<i>Lower window/upper measurement (LU)</i>		
Feed	Gate 1 Channel A	See Table 0-19
Measurement	Peak	See Table 0-19
<i>Lower window/lower measurement (LL)</i>		
Feed	Gate 1 Channel A	See Table 0-19

Function	Setting	
	No Sensor	Non E9320 Sensor
Measurement	Peak to avg	See Table 0-19

1. For further information refer to “Primary and secondary channels”, on page 11-28.

Table 0-19: WCDMA: Power Meter Presets For Secondary Channel Sensors

Function	Secondary Channel Sensor		
	No Sensor	Non E9320 Sensor	E9320 Sensor
<i>Display setup</i>			
Upper window	UU single numeric	Dual numeric	Dual numeric
Lower window	Dual numeric	Dual numeric	Dual numeric
<i>Upper window/lower measurement (UL)</i>			
Feed	DEF	Gate 1 primary channel ¹	Gate 1 primary channel ¹ (channel A)
Measurement	DEF	Peak	Peak
<i>Lower window/upper measurement (LU)</i>			
Feed	Gate 1 primary channel ¹	Gate 1 primary channel ¹	Gate 1 secondary channel ¹ (channel B)
Measurement	Peak	Peak to avg	Avg
<i>Lower window/lower measurement (LL)</i>			
Feed	Gate 1 primary channel ¹	Secondary channel ¹	Gate1 secondary channel ¹ (channel B)
Measurement	Peak to avg	Avg	Peak to avg

1. For further information refer to “Primary and secondary channels”, on page 11-28.

CDMA2000

The cdma2000 set-up provides:

- Average power in a cdma2000 signal (bandwidth ≤ 5 MHz).
- Peak power and peak-to-average ratio of the signal over a defined, statistically valid number of samples. The reading is continuously refreshed. This indicates how cdma2000 channel loading affects peak power and power distribution.

The measurement is a continuously gated measurement on a 3GPP cdma2000 signal. Its aim is to measure the peak and average power corresponding to a $<0.01\%$ probability that there are no peaks above the returned peak reading. Time gating is set to 10ms, corresponding to 200,000 samples. Triggering is set to occur continuously internally to the meter. The internal trigger is set to AutoLevel. A reading over the 10ms period is returned, then the reading is re-initiated for the next 10ms period. In this way the reading always relates to a position beyond 0.01% on the CCDF curve and will refresh to track any signal or DUT changes.

The following table shows the power meter presets when <character_data> is set to CDMA2000. Commands not listed are preset according to their DEFault values (for further information refer to Table 11-1):

Table 0-20: CDMA2000: Power Meter Presets

Command	Setting	Comments
<i>Frequency</i>		
[SENS[1]] SENS2:FREQ[:CW :FIX]	+1900.000 MHz	Frequency setting
<i>Sensor measurement mode</i>		
[SENS[1]] SENS2:DET:FUNC	NORM	Measurement mode
<i>Sensor video bandwidth setup</i>		
[SENS[1]] SENS2:BAND BWID:VID	E9321A/25A: DEF E9322A/26A: DEF E9323A/27A: HIGH	Sensor video bandwidth
<i>Gate setup</i>		
[SENS[1]] SENS2:SWE[1] 2 3 4 :OFF:TIME	Gates 1 - 4: 0	Delay between trigger point and time gated period.
[SENS[1]] SENS2:SWE[1] 2 3 4 :TIME	Gate 1: 10 ms Gates 2 - 4: 0	Length of time gated period for time gated measurements.
<i>Trigger setup</i>		

Command	Setting	Comments
TRIGger [:SEQuence[1] 2] :SOUR	INT1	Trigger source set up and acquisition mode continuous triggering
INIT:CONT	ON	
TRIG[:SEQ]:LEV:AUTO	ON	Enable automatic setting of the trigger level
TRIG[:SEQ]:LEV	Automatically determined by power meter	Power level
TRIG[:SEQ]:SLOP	POS	Trigger event recognized on the rising edge of a signal
TRIG[:SEQ]:DEL	0	Delay between recognition of trigger event and start of a measurement
TRIG[:SEQ]:HOLD	MIN	Trigger holdoff
<i>Step detection</i>		
[SENSe[1]] SENS2: AVER: SDET	0	Step detection disabled

Table 0-21: CDMA2000: Power Meter Presets: Window/Measurement Settings

Function	Setting	
	No Sensor	Non E9320 Sensor
<i>Display setup</i>		
Upper window	UU single numeric	UU single numeric
Lower window	Dual numeric	See Table 0-22
<i>Window/measurement setup</i>		
<i>Upper window/upper measurement (UU)</i>		
Feed	Gate 1 channel A	Gate 1 primary channel ¹
Measurement	Avg	Avg
<i>Upper window/lower measurement (UL)</i>		
Feed	DEF	DEF
Measurement	DEF	DEF
<i>Lower window/upper measurement (LU)</i>		
Feed	Gate 1 Channel A	Gate1 primary channel ¹
Measurement	Peak	Peak
<i>Lower window/lower measurement (LL)</i>		
Feed	Gate 1 Channel A	See Table 0-22

Function	Setting	
	No Sensor	Non E9320 Sensor
Measurement	Peak to avg	See Table 0-22

1. For further information refer to “Primary and secondary channels”, on page 11-28.

Table 0-22: CDMA2000: Power Meter Presets For Secondary Channel Sensors

Function	Secondary Channel Sensor		
	No Sensor	Non E9320 Sensor	E9320 Sensor
<i>Display setup</i>			
Upper window	UU single numeric	Dual numeric	Dual numeric
Lower window	Dual numeric	Dual numeric	Dual numeric
<i>Upper window/lower measurement (UL)</i>			
Feed	DEF	Gate 1 primary channel ¹	Gate 1 primary channel ¹ (channel A)
Measurement	DEF	Peak	Peak
<i>Lower window/upper measurement (LU)</i>			
Feed	Gate 1 primary channel ¹	Gate 1 primary channel ¹	Gate 1 secondary channel ¹ (channel B)
Measurement	Peak	Peak to avg	Avg
<i>Lower window/lower measurement (LL)</i>			
Feed	Gate 1 primary channel ¹	Secondary channel ¹	Gate1 secondary channel ¹ (channel B)
Measurement	Peak to avg	Avg	Peak to avg

1. For further information refer to “Primary and secondary channels”, on page 11-28.

IDEN

The iDEN set-up provides:

- Average power in one iDEN training and data pulse.
- Peak-to-average one iDEN training and data pulse.
- Average power in a 90ms iDEN frame.

The measurement is started by detecting the iDEN training burst—for example the burst emitted by a mobile—using the internal RF level trigger. Time gating is used to measure the average power in the following 15ms (data pulse). Gate 1 is used to measure this data pulse. The 90ms frame is also captured to measure the average power in the entire frame. Gate 2 is used to measure the 90ms frame.

The following table shows the power meter presets when <character_data> is set to IDEN. Commands not listed are preset according to their DEFault values (for further information refer to Table 11-1):

Table 0-23: iDEN: Power Meter Presets

Command	Setting	Comments
<i>Frequency</i>		
[SENS [1]] SENS2 : FREQ [: CW : FIX]	+800.000 MHz	Frequency setting
<i>Sensor measurement mode</i>		
[SENS [1]] SENS2 : DET : FUNC	NORM	Measurement mode
<i>Sensor video bandwidth setup</i>		
[SENS [1]] SENS2 : BAND BWID : VID	E9321A/25A: OFF E9322A/26A: OFF E9323A/27A: OFF	Sensor video bandwidth
<i>Gate setup</i>		
[SENS [1]] SENS2 : SWE [1] 2 3 4 : OFF : TIME	Gate 1: 10 us Gates 2 - 4: 0	Delay between trigger point and time gated period.
[SENS [1]] SENS2 : SWE [1] 2 3 4 : TIME	Gate 1: 15 ms Gate 2: 90 ms Gates 3 - 4: 0	Length of time gated period for time gated measurements.
<i>Trigger setup</i>		
TRIG [: SEQ [1] 2] : SOUR	INT1	Trigger source set up and acquisition mode continuous triggering
INIT : CONT	ON	
TRIG [: SEQ] : LEV : AUTO	OFF	Disable automatic setting of the trigger level
TRIG [: SEQ] : LEV	-20 dBm	Power level

Command	Setting	Comments
TRIG[:SEQ]:SLOP	POS	Trigger event recognized on the rising edge of a signal
TRIG[:SEQ]:DEL	0	Delay between recognition of trigger event and start of a measurement
TRIG[:SEQ]:HOLD	20 ms	Trigger holdoff
<i>Step detection</i>		
[SENSe[1]] SENS2:AVER:SDET	1	Step detection enabled

Table 0-24: iDEN: Power Meter Presets: Window/Measurement Settings

Function	Setting	
	No Sensor	Non E9320 Sensor
<i>Display setup</i>		
Upper window	UU single numeric	See Table 0-25
Lower window	Dual numeric	See Table 0-25
<i>Window/measurement setup</i>		
<i>Upper window/upper measurement (UU)</i>		
Feed	Gate 1 channel A	Gate 1 primary channel ¹
Measurement	Avg	Avg
<i>Upper window/lower measurement (UL)</i>		
Feed	DEF	See Table 0-25
Measurement	DEF	See Table 0-25
<i>Lower window/upper measurement (LU)</i>		
Feed	Gate 1 Channel A	See Table 0-25
Measurement	Peak to avg	See Table 0-25
<i>Lower window/lower measurement (LL)</i>		
Feed	Gate 2 Channel A	See Table 0-25
Measurement	Avg	See Table 0-25

1. For further information refer to “Primary and secondary channels”, on page 11-28.

Table 0-25: iDEN: Power Meter Presets For Secondary Channel Sensors

Function	Secondary Channel Sensor		
	No Sensor	Non E9320 Sensor	E9320 Sensor
<i>Display setup</i>			
Upper window	UU single numeric	Dual numeric	Dual numeric
Lower window	Dual numeric	Dual numeric	Dual numeric
<i>Upper window/lower measurement (UL)</i>			
Feed	DEF	Gate 1 primary channel ¹	Gate 1 primary channel ¹ (channel A)
Measurement	DEF	Peak to Avg	Peak to Avg
<i>Lower window/upper measurement (LU)</i>			
Feed	Gate 1 primary channel ¹	Gate 2 primary channel ¹	Gate 1 secondary channel ¹ (channel B)
Measurement	Peak to avg	Avg	Avg
<i>Lower window/lower measurement (LL)</i>			
Feed	Gate 2 primary channel ¹	Secondary channel ¹	Gate1 secondary channel ¹ (channel B)
Measurement	Avg	Avg	Avg

1. For further information refer to “Primary and secondary channels”, on page 11-28.

SYSTem:REMOte

This command locks the power meter front panel keypad excepting the **Local** key. The power meter display status reporting line will show “RMT”. Local front panel operation of the power meter is inhibited but can be enabled by pressing the **Local** key.

Syntax

The diagram shows the command syntax SYST:REM. The word SYST is enclosed in an oval, followed by a right-pointing arrow. This is followed by the word REM, also enclosed in an oval, followed by another right-pointing arrow.

Example

SYST:REM

*This command locks the power meter front panel keypad excepting the **Local** key.*

Error Messages

If this command is sent when the GPIB interface is selected, the error -113, “Undefined header” occurs.

SYSTEM:RINTerface GPIB|RS232|RS422

This command allows the remote control interface to be selected from GPIB, RS232, and RS422 .

Syntax

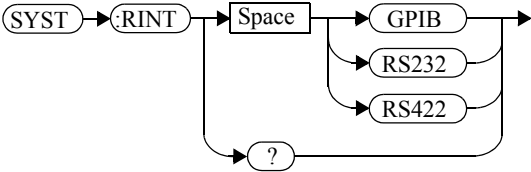

Example

```
SYSTEM:RINT RS232
```

This command sets the power meter remote control interface to RS232.

Query

```
SYSTEM:RINTerface?
```

The query returns the current setting of the remote control interface (GPIB, RS232, or RS422).

Query Example

```
SYSTEM:RINT?
```

This command queries the current setting of the remote control interface.

SYSTem:RWLock

This command locks out the front panel keypad - including the front panel Local key. The power meter display status reporting line will show “RMT”. In this state the power meter cannot be returned to manual control from the front panel.

Syntax

SYST → **:RWL** →

Example

SYST :RWL

*This command locks the power meter front panel keypad - including the **Local** key.*

Error Messages

If this command is sent when the GPIB interface is selected, the error -113, “Undefined header” occurs.

SYSTem:VERSion?

This query returns the version of SCPI used in the power meter. The response is in the form of XXXX.Y, where XXXX is the year and Y is the version number.

Syntax



Example

SYST:VERS?

This command queries which version of SCPI is used in the power meter.

SYSTem Subsystem
SYSTem:VERSiOn?

THIS PAGE HAS BEEN INTENTIONALLY LEFT BLANK.

12

———— **TRACe Subsystem**

TRACe Subsystem

Note This command can only be used with E9320 Series sensors.

The TRACe subsystem is used to:

- Specify the type of trace to be captured.
- Enable/disable trace capture.
- Specify the trace units.

There are two pre-defined TRACE blocks:

- TRACe1: associated with channel A.
- TRACe2: associated with channel B.

The following commands are described in this chapter:

Keyword	Parameter Form	Notes	Page
TRACe[1] 2			
[:DATA]?	<character_data>	[query only]	page 12-3
:STATE	<boolean>		page 12-5
:UNIT	<character_data>		page 12-6

TRACe[1]|2[:DATA]? <character_data>

This query returns trace data from the specified channel. The trace resolution is determined by <character_data>.

Note This command cannot be used over RS232 or RS422 serial interfaces.

Data is returned in IEEE 488.2 arbitrary block program data format as follows:

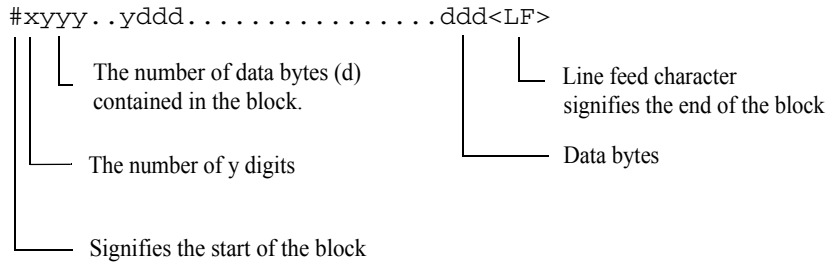

Example: if there are 12435 data bytes, y = 12435 and x = 5

Each point in the trace is represented as an IEEE 754 32 bit floating point number, made up of four bytes in the data block. The MS byte is transmitted first. Each complete block is terminated by a line feed.

Note TRACe data formatting is not affected by FORMAt subsystem formatting.

Syntax

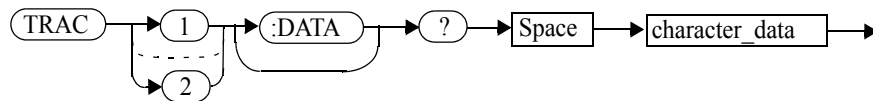

Parameters

Item	Description/Default	Range of Values
character_data	<ul style="list-style-type: none">• HRESolution: high resolution. The complete capture buffer at the internal sample rate. The number of points in this trace is determined by SENS:TRACe:TIME.• MRESolution: medium resolution. A subset of the capture buffer decimated to 1000 points.• LRESolution: low resolution. A subset of the capture buffer, decimated to the number of points required for the display. This is really a way of outputting the same data used to generate the graphical power display.	HRES MRES LRES

Example

TRAC:DATA? HRES

This command returns the trace data for channel A at high resolution.

Error Messages

If TRAC:STAT is off, the error -221, “Settings Conflict” occurs.

TRACe[1]|2:STATe <boolean>

This command enables or disables trace capture for the specified channel.

Syntax

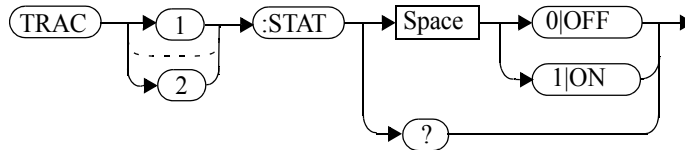

Example

```
TRAC2 : STAT 1
```

This command enables trace capture for channel B.

Reset Condition

On reset trace capture is set to OFF.

Query

```
TRACe [ 1 ] | 2 : STATe?
```

The query command enters a 1 or 0 into the output buffer indicating whether or not trace capture is enabled or disabled.

- 1 is returned when trace capture is enabled.
- 0 is returned when trace capture is disabled.

Query Example

```
TRAC1 : STAT?
```

This command queries the current state of trace capture for channel A.

Error Messages

- If an E-Series E9320 sensor is not connected, error -241, “Hardware missing” occurs.
- If an E-Series E9320 sensor is connected and set to AVERAge mode rather than NORMAl mode, error -221, “Settings conflict” occurs.

TRACe[1]|2:UNIT <character_data>

This command sets the units for the trace for the specified channel

Note This command is included for compatibility purposes only. It has the same purpose as
 [SENSe[1]] | SENSe2:TRACe:UNIT <character_data>
 which should be used in preference.

Syntax

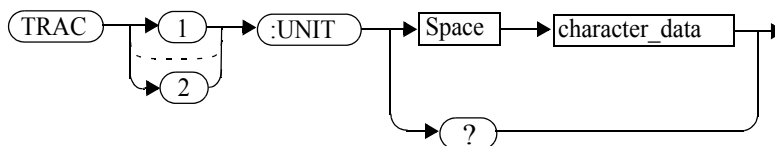

Parameters

Item	Description/Default	Range of Values
character_data	<ul style="list-style-type: none"> • DBM: dBm. • W: Watts. 	DBM W

Example

TRAC2:UNIT W

This command sets the trace units for channel B Watts.

Reset Condition

On reset the units are set to dBm.

Query

TRACe[1] | 2:UNIT?

The query command returns the current value of character_data.

Query Example

TRAC2 : UNIT?

This command queries the current trace units for channel B.

THIS PAGE HAS BEEN INTENTIONALLY LEFT BLANK.

13

———— **TRIGger Subsystem**

TRIGger Subsystem

The TRIGger subsystem is used to synchronize device actions with events. It includes the ABORT, INITiate and TRIGger commands. These are all at the root level in the command hierarchy but they are grouped here because of their close functional relationship.

Keyword	Parameter Form	Notes	Page
ABORT [1] 2		[no query] [non-SCPI]	page 13-3
INITiate [1] 2			
:CONTinuous	<boolean>		page 13-5
[:IMMediate]		[no query]	page 13-7
INITiate			
:CONTinuous			
:ALL	<boolean>		page 13-8
:SEQuence [1] 2	<boolean>		page 13-9
[:IMMediate]			
:ALL		[no query]	page 13-11
:SEQuence [1] 2		[no query]	page 13-12
TRIGger [1] 2			
:DELAy			
:AUTO	<boolean>		page 13-14
[:IMMediate]		[no query]	page 13-16
:SOURce	BUS EXTeRnal HOLD IMMediate INTeRnal [[1] 2]		page 13-17
TRIGger			
[:SEQuence]			
:DELAy	<numeric_value>		page 13-17
:HOLDoff	<numeric_value>		page 13-21
:HYSTeresis	<numeric_value>		page 13-23
:LEVel	<numeric_value>		page 13-25
:AUTO	<boolean>		page 13-27
:SLOPe	<character_data>		page 13-29
[:SEQuence [1] 2]			
:COUNt	<numeric_value>		page 13-31
:DELAy			
:AUTO	<boolean>		page 13-33
:IMMediate		[no query]	page 13-35
:SOURce	BUS EXTeRnal HOLD IMMediate INTeRnal [[1] 2]		page 13-36

Many of the above commands contain a numeric which represents a channel number. For example TRIGger1 and TRIGger2 represent channel A and channel B respectively. Channel B commands cannot be used with the single channel 4416A power meter and result in the error “Header suffix out of range.”

ABORt[1]|2]

This command removes the specified channel from the wait for trigger state and places it in the idle state. It does not affect any other settings of the trigger system. When the INITiate command is sent, the trigger system responds as it did before ABORt was executed.

If INITiate:CONTinuous is ON, then after ABORt the specified channel immediately goes into the wait for trigger state.

Syntax

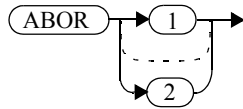

Example

ABOR

This command places channel A in the idle state.

INITiate Commands

Initiate commands allow you to place the power meter in the wait for trigger state.

The `INITiate` commands are overlapped, that is, the power meter can continue parsing and executing subsequent commands while initiated. Refer to IEEE 488.2, section 12 for further details. Note that the pending operation flag is set when the power meter moves out of the idle state and is cleared when it re-enters the idle state.

The following commands are described in this section:

```
INITiate[1] | 2:CONTinuous <boolean>  
INITiate[1] | 2[:IMMediate]  
INITiate:CONTinuous:ALL <boolean>  
INITiate:CONTinuous:SEQuence[1] | 2 <boolean>  
INITiate[:IMMediate]:ALL  
INITiate[:IMMediate]:SEQuence[1] | 2
```

INITiate[1]2:CONTInuous <boolean>

This command sets the power meter for either a single trigger cycle or continuous trigger cycles. A trigger cycle means that the power meter exits the wait for trigger state and starts a measurement.

When entering local mode, if TRIGger [:SEQuence [1] | 2] :SOURce is set to INT [[1] | 2] or EXT, INITiate:CONTInuous is not changed. For other trigger sources, INITiate:CONTInuous is set to ON.

If INITiate:CONTInuous is set to:

- OFF, the trigger system remains in the idle state until it is set to ON, or INITiate:IMMEdiate is received. Once this trigger cycle is complete the trigger system returns to the idle state.
- ON, the trigger system is initiated and exits the idle state. On completion of each trigger cycle, the trigger system immediately commences another trigger cycle without entering the idle state.

Note

This command performs the same function as
 INITiate:CONTInuous:SEQuence [1] | 2 <boolean>.

Syntax

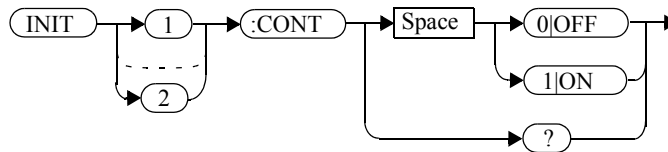

Example

```
INIT2:CONT ON
```

This command places channel B in the wait for trigger state.

Reset Condition

On reset (*RST), this command is set to OFF.

On preset (SYSTEM:PRESet) and instrument power-up, when entering local mode, if TRIGger [:SEQuence [1] | 2] :SOURce is set to INT [[1] | 2] or EXT,

TRIGger Subsystem
INITiate[1]|2:CONTInuous <boolean>

INITiate:CONTInuous is not changed. For other trigger sources, INITiate:CONTInuous is set to ON.

Query

INITiate[1] | 2:CONTInuous?

The query enters a 1 or 0 into the output buffer.

- 1 is returned when there is continuous triggering.
- 0 is returned when there is only a single trigger.

Query Example

INIT2:CONT?

This command queries whether channel B is set for single or continuous triggering.

INITiate[1]2[:IMMEDIATE]

This command sets the power meter in the wait for trigger state. When a trigger is received, the measurement is taken and the result placed in the power meter memory. If TRIGger:SOURce is set to IMMEDIATE the measurement begins as soon as INITiate:IMMEDIATE is executed.

Use FETCh? to transfer a measurement from memory to the output buffer. Refer to “FETCh[1]2|3|4 Queries”, on page 2-21 for further details.

Note

This command performs the same function as
 INITiate:[IMMEDIATE]:SEQuence[1] | 2.

Syntax

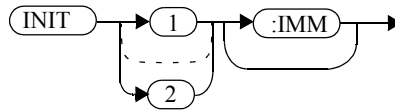

Example

INIT2:IMM

This command places channel B in the wait for trigger state.

Error Messages

If the power meter is not in the idle state or INITiate:CONTinuous is ON, error -213, “INIT ignored” occurs.

INITiate:CONTInuous:ALL <boolean>

Sets all trigger sequences to be continuously initiated.

If INITiate:CONTInuous:ALL is set to:

- ON, trigger sequences are set to be continuously initiated.
- OFF, trigger sequences are not set to be continuously initiated.

Syntax

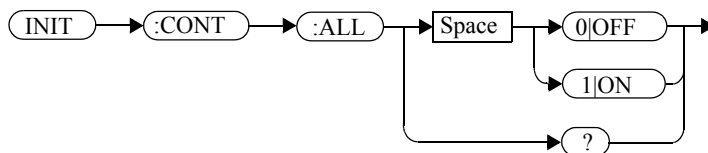

Example

```
INIT:CONT:ALL ON
```

This command sets all trigger sequences to be continuously initiated.

Reset Condition

On reset (*RST), this command is set to OFF.

On preset (SYSTEM:PRESet) and instrument power-up, when entering local mode, if TRIGger[:SEquence[1]|2]:SOURCE is set to INT[[1]|2] or EXT, INITiate:CONTInuous is not changed. For other trigger sources, INITiate:CONTInuous is set to ON.

Query

```
INITiate:CONTInuous:ALL?
```

The query enters a 1 or 0 into the output buffer.

- 1 is returned when trigger sequences are set to be continuously initiated.
- 0 is returned when trigger sequences are not set to be continuously initiated.

Query Example

```
INIT:CONT:ALL?
```

This command queries whether both channels are in a wait for trigger state.

INITiate:CONTInuous:SEQuence[1]|2 <boolean>

This command sets the power meter for either a single trigger cycle or continuous trigger cycles. A trigger cycle means that the power meter exits the wait for trigger state and starts a measurement. When entering local mode, INITiate:CONTInuous is set to ON.

If INITiate:CONTInuous:SEQuence[1|2] <boolean> is set to:

- OFF, the trigger system remains in the idle state until it is set to ON, or INITiate:IMMEDIATE is received. Once this trigger cycle is complete the trigger system returns to the idle state.
- ON, the trigger system is initiated and exits the idle state. On completion of each trigger cycle, the trigger system immediately commences another trigger cycle without entering the idle state.

Note This command performs the same functions as INITiate[1|2]:CONTInuous <boolean>.

Syntax

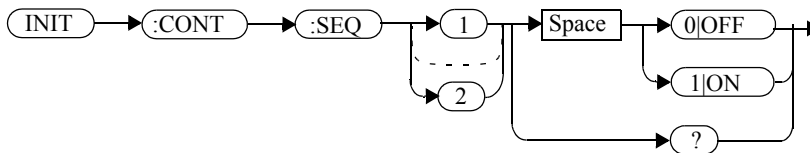

Example

INIT:CONT:SEQ2 ON

This command places channel B in a wait for trigger state.

Reset Condition

On reset (*RST), this command is disabled.

On preset (SYSTEM:PRESet) and instrument power-up, this command is enabled.

TRIGger Subsystem
INITiate:CONTInuous:SEQuence[1]2 <boolean>

Query

INITiate[1] | 2:CONTInuous:SEQuence?

The query enters a 1 or 0 into the output buffer.

- 1 is returned when there is continuous triggering.
- 0 is returned when there is only a single trigger.

Query Example

INIT2:CONT:SEQ?

This command queries whether channel B is set for single or continuous triggering.

INITiate[:IMMediate]:ALL

This command initiates all trigger sequences.

Syntax



Example

INIT:IMM:ALL

This command initiates all trigger sequences.

Error Messages

If the power meter is not in the idle state or INITiate:CONTinuous is ON, error -213, “INIT ignored” occurs.

INITiate[:IMMEDIATE]:SEQUENCE[1]|2

This command sets the power meter in the wait for trigger state. When a trigger is received, the measurement is taken and the result placed in the power meter memory. If TRIGger:SOURce is set to IMMEDIATE the measurement begins as soon as INITiate:IMMEDIATE is executed.

Use FETCh? to transfer a measurement from memory to the output buffer. Refer to FETCh1|2|3|4 in chapter 2 for further information.

Note This command performs the same function as INITiate[1] | 2: [IMMEDIATE].

Syntax

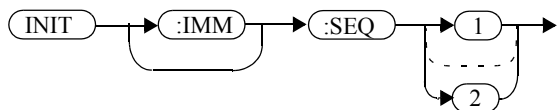

Example

INIT:IMM:SEQ1

This command places channel A in the wait for trigger state.

Error Messages

If the power meter is not in the “idle” state or INITiate:CONTinuous is ON, error -213, “INIT ignored” occurs.

TRIGger Commands

TRIGger commands control the behavior of the trigger system.

The following commands are described in this section:

```
TRIGger[1] | 2:DElay:AUTO <boolean>
TRIGger[1] | 2[:IMMediate]
TRIGger[1] | 2:SOURce BUS|IMMediate|HOLD
TRIGger[:SEQuence]:DElay <numeric_value>
TRIGger[:SEQuence]:HOLDoff <numeric_value>
TRIGger[:SEQuence]:HYSTeresis <numeric_value>
TRIGger[:SEQuence]:LEVel <numeric_value>
TRIGger[:SEQuence]:LEVel:AUTO <boolean>
TRIGger[:SEQuence]:SLOPe <character_data>
TRIGger[:SEQuence[1] | 2]:COUnT <numeric_value>
TRIGger[:SEQuence[1] | 2]:DElay:AUTO <boolean>
TRIGger[:SEQuence[1] | 2]:IMMediate
TRIGger[:SEQuence[1] | 2]:SOURce
    BUS|EXTErnal|HOLD|IMMediate|INTernAl[[1] | 2
```

TRIGger[1]|2:DElay:AUTO <boolean>

This command is used to determine whether or not there is a settling-time delay before a measurement is made.

When this command is set to:

- ON, the power meter inserts a settling-time delay before taking the requested measurement. This settling time allows the internal digital filter to be updated with new values to produce valid, accurate measurement results. The trigger with delay command allows settling time for the internal amplifiers and filters. It does not allow time for power sensor delay

In cases of large power changes, the delay may not be sufficient for complete settling. Accurate readings can be assured by taking two successive measurements for comparison.

- OFF, the power meter makes the measurement immediately a trigger is received.

TRIGger [1] | 2 :DElay:AUTO is ignored if TRIGger [1] | 2 [:IMMEDIATE] is set to ON.

Syntax

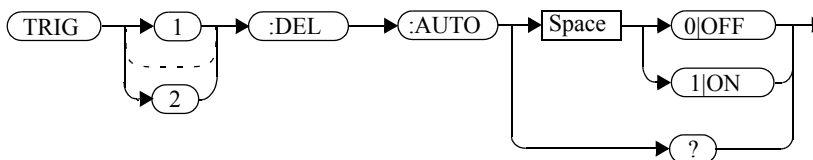

Example

```
TRIG:DEL:AUTO ON
```

This command enables a delay on channel A.

Reset Condition

On reset, TRIGger :DElay:AUTO is set to ON.

Query

TRIGger:DELay:AUTO?

The query enters a 1 or 0 into the output buffer indicating the status of TRIGger:DELay:AUTO.

- 1 is returned when it is ON.
- 0 is returned when it is OFF.

TRIGger[1]|2[:IMMEDIATE]

This command causes a trigger to occur immediately, provided the specified channel is in the wait for trigger state. When this command is executed, the measurement result is stored in the power meter's memory. Use `FETCh?` to place the measurement result in the output buffer.

`TRIGger [1] | 2 : DELay : AUTO` is ignored if `TRIGger [1] | 2 [: IMMEDIATE]` is set to ON.

Note This command performs the same function as `INITiate[1] | 2 : [IMMEDIATE]`.

Syntax

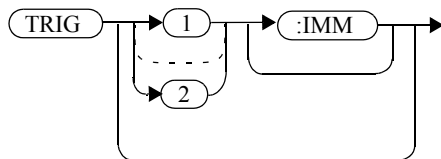

Example

TRIG

This command causes a channel A trigger to occur immediately.

Error Messages

If the power meter is not in the wait for trigger state, then `TRIGger : IMMEDIATE` causes error -211, "Trigger ignored".

TRIGger[1]|2:SOURce BUS|EXTErnal|HOLD|IMMediate|INTernAl[[1]|2]

This command configures the trigger system to respond to the specified source. This command only selects the trigger source. Use the `INITiate` command to place the power meter in the wait for trigger state.

Note This command has been included for compatibility purposes. It has the same purpose as `TRIGger[:SEquence[1]|2]:SOURce BUS|EXTErnal|HOLD|IMMediate|INTernAl[[1]|2]` which should be used in preference.

Syntax

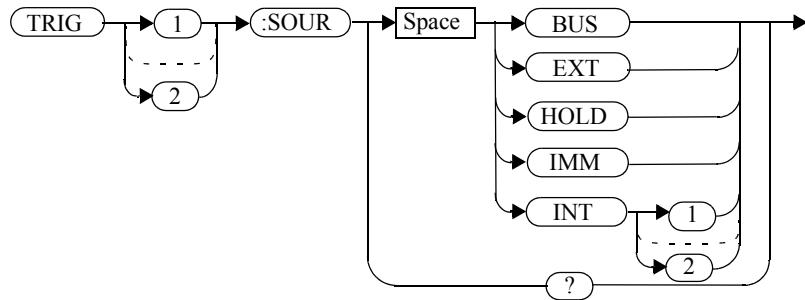

Parameters

Item	Description/Default	Range of Values
source	<p>Available trigger sources:</p> <ul style="list-style-type: none"> BUS: the trigger source is the group execute trigger <code><GET></code> bus command, a <code>*TRG</code> common command or the <code>TRIGGER:IMMediate</code> SCPI command. EXTErnal: the trigger source is the trigger input in the back panel. HOLD: triggering is suspended. The only way to trigger the power meter is to use <code>TRIGger:IMMediate</code>. IMMediate: the trigger system is always true. If <code>INITiate:CONTinuous</code> is ON the power meter is continually triggering free (free run mode). If an <code>INITiate:IMMediate</code> command is sent a measurement is triggered then the power meter returns to the idle state. INTernAl: either INT1 (channel A) or INT2 (channel B). 	<p>BUS EXTErnal HOLD IMMediate INTernAl[[1] 2]</p>

Note

The trigger source is set to IMMeDiate on instrument power-up and when entering local mode.

The MEASure and CONFIgure commands automatically set the trigger source to IMMeDiate.

The READ? or MEASure commands should not be used if the trigger source is set to BUS or HOLD.

Example

```
TRIG:SOUR IMM
```

This command configures channel A for immediate triggering.

Reset Condition

On reset, the trigger source is set to IMMeDiate.

Query

```
TRIGger:SOURce?
```

The query returns the current trigger source, either IMM, BUS or HOLD.

Query Example

```
TRIG:SOUR?
```

This command queries channel A's trigger source.

Error Messages

- For dual channel power meters: if the master is changed to IMM, BUS or HOLD, error -221 “Settings Conflict” occurs. In such situations the slave’s TRIG:SOUR must be changed so that it is no longer a slave.
- If the source is changed to INT1, INT2 or EXT and SENS:SPEED has a value of 200, error -221 “Settings Conflict” occurs.
- If the source is changed to INT1, INT2 or EXT and SENS:DET:FUNC is set to AVERAge, error -221 “Settings Conflict” occurs.

TRIGger[:SEQuence]:DELay <numeric_value>

This command sets the delay between the recognition of a trigger event and the start of a measurement.

Note The command is accepted for TRIGger [: SEQuence [1]] (channel A) only, for both single and dual channel power meters.

Syntax

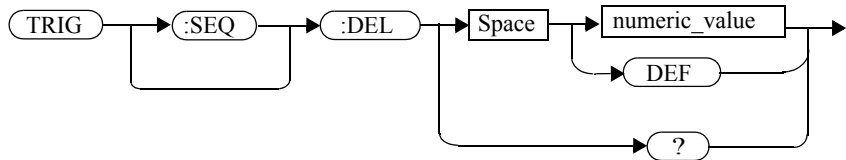

Parameters

Item	Description/Default	Range of Values
numeric_value	The delay between the recognition of a trigger event and the start of the measurement. <ul style="list-style-type: none"> DEF : the default value is 0 seconds. Units are resolved to 50 ns.	-1 to 1 seconds DEF

Example

TRIG:SEQ:DEL 0.001

This command sets a delay of 1 ms for channel A.

Reset Condition

On reset, the trigger delay is set to 0 seconds.

TRIGger Subsystem

TRIGger[:SEQuence]:DELay <numeric_value>

Query

TRIGger [:SEQuence] :DELay?

The query returns the current setting of the trigger delay.

Query Example

TRIG:SEQ:DEL?

This command queries the trigger delay of channel A.

Reset Condition

On reset, trigger delay is set to 0 seconds.

TRIGger[:SEQuence]:HOLDoff <numeric_value>

This command sets the trigger holdoff in seconds.

Note The command is accepted for TRIGger [: SEQuence [1]] (channel A) only, for both single and dual channel power meters.

Syntax

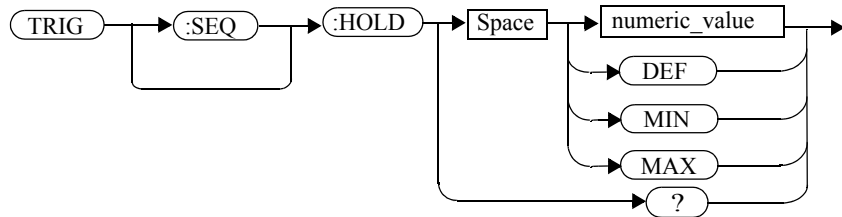

Parameters

Item	Description/Default	Range of Values
numeric_value	The trigger holdoff in seconds. <ul style="list-style-type: none"> DEF: the default value is 1 us. MIN: 1 us. MAX: 400 ms. Units are resolved to 100 ns.	1 us to 0.4 seconds DEF MIN MAX

Example

TRIG:SEQ1:HOLD 0.1

This command sets the trigger holdoff to 100 ms for channel A.

Reset Condition

On reset the trigger holdoff is set to 1 us.

TRIGger Subsystem
TRIGger[:SEQuence]:HOLDoff <numeric_value>

Query

TRIGger [:SEQuence] :HOLDoff?

The query returns the current trigger holdoff setting.

Query Example

TRIG:SEQ:HOLD?

This command queries the trigger holdoff setting for channel A.

TRIGger[:SEquence]:HYSTeresis <numeric_value>

This command sets:

- How far a signal must fall below TRIG:LEVel before a rising edge can be detected.
- How far a signal must rise above TRIG:LEVel before a falling edge can be detected.

Note The command is accepted for TRIGger[:SEquence[1]] (channel A) only, for both single and dual channel power meters.

Syntax

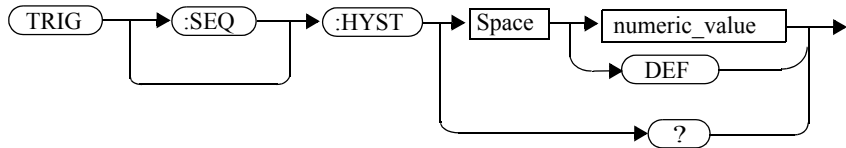

Example

TRIG:SEQ:HYST 0.1

This command sets the value to 2 dB for channel A.

Parameters

Item	Description/Default	Range of Values
numeric_value	How far a signal must fall/rise before a rising or falling edge can be detected. DEF: the default value is 0 dB. Units are resolved to 0.05 dB.	0 to 3 dB DEF

Reset Condition

On reset the value is set to 0 dB.

TRIGger Subsystem
TRIGger[:SEQuence]:HYSTeresis <numeric_value>

Query

TRIGger [:SEQuence] :HYSTeresis?

The query returns the current value in dB.

Query Example

TRIG:SEQ:HYST?

This command queries the value for channel A.

TRIGger[:SEQuence]:LEVel <numeric_value>

This command sets the power level at which a trigger event is recognized.

Note The command is accepted for TRIGger [: SEQuence [1]] (channel A) only, for both single and dual channel power meters.

Syntax

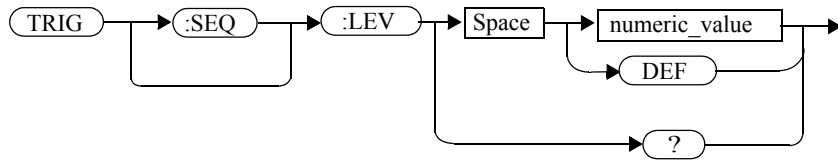

Example

TRIG:SEQ:LEV 10

This command sets the power level for a trigger event to 10 dBm

Parameters

Item	Description/Default	Range of Values
numeric_value	The power level at which a trigger event is recognized. <ul style="list-style-type: none"> DEF : the default value is 0 dBm. Units are resolved to 0.1 dBm.	-40 to 20 dBm DEF

Reset Condition

On reset the power level is set to 0 dBm.

Query

TRIGger [: SEQuence] : LEVel ?

The query returns the current power level setting.

TRIGger Subsystem
TRIGger[:SEQuence]:LEVel <numeric_value>

Query Example

TRIG:SEQ1:LEV?

This command queries the power level setting for channel A.

TRIGger[:SEquence]:LEVel:AUTO <boolean>

This command enables/disables automatic setting of the trigger level.

When this command is set to:

- ON, automatic setting of the trigger level is enabled.
- OFF, automatic setting of the trigger level is disabled.
- ONCE, automatic setting of the trigger level is enabled for one trigger event only. The value is then set to OFF.

Note The command is accepted for TRIGger [: SEquence [1]] (channel A) only, for both single and dual channel power meters.

Syntax

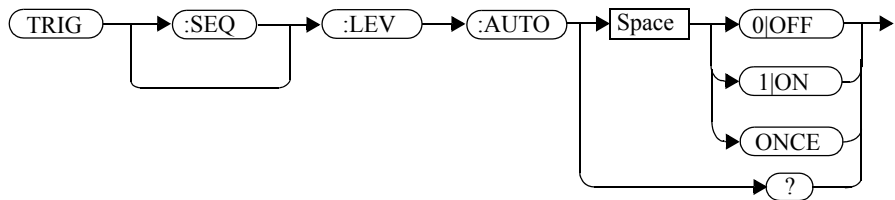

Example

```
TRIG:SEQ:LEV:AUTO 0
```

This command disables the automatic setting of the trigger level for channel A.

Reset Condition

On reset the value is set to ON.

Query

```
TRIGger [ : SEquence ] : LEVel : AUTO?
```

The query enters a 1 or 0 into the output buffer indicating the status of TRIGger [: SEquence] : LEVel : AUTO.

- 1 is returned when it is ON.
- 0 is returned when it is OFF.

TRIGger Subsystem
TRIGger[:SEQuence]:LEVel:AUTO <boolean>

Query Example

TRIG:SEQ:LEV:AUTO?

This command queries the setting for channel A.

TRIGger[:SEQuence]:SLOPe <character_data>

This command specifies whether a trigger event is recognized on the rising or falling edge of a signal.

Note The command is accepted for TRIGger [: SEQuence [1]] (channel A) only, for both single and dual channel power meters.

Syntax

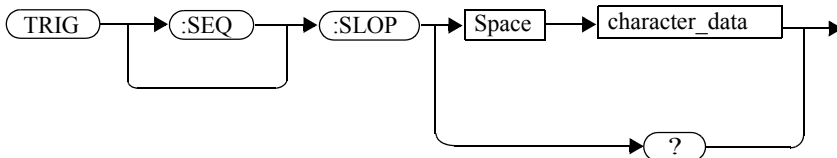

Parameters

Item	Description/Default	Range of Values
character_data	How a trigger event is recognized: <ul style="list-style-type: none"> • POSitive: a trigger event is recognized on the rising edge of a signal. • NEGative: a trigger event is recognized on the falling edge of a signal. 	POSitive NEGative

Reset Condition

On reset the value is set to POSitive.

Query

TRIGger [: SEQuence] : SLOPe?

The query returns the current value of <character_data>.

TRIGger Subsystem
TRIGger[:SEQuence]:SLOPe <character_data>

Query Example

TRIG:SEQ:SLOP?

This command queries the current value of <character_data> for channel A.

TRIGger[:SEquence[1]]2:COUNT <numeric_value>

This command controls the path of the trigger subsystem in the upward traverse of the wait for trigger state. COUNT loops through the event detection/measurement cycle are performed. That is, COUNT measurements are performed in response to COUNT trigger events.

COUNT can be set to a value >1 only when:

- [SENSe[1]] | SENSe2:MRATe <character_data> is set to FAST and
- TRIGger[1] | 2:SOURce set to BUS, IMMEDIATE or HOLD.

Syntax

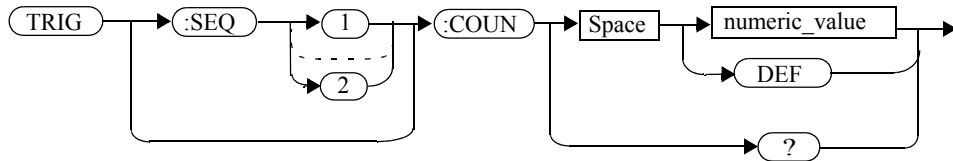

Parameters

Item	Description/Default	Range of Values
numeric_value	The number of triggered events for the measurement cycle. <ul style="list-style-type: none"> • DEF: the default value is 1. 	1 to 50 DEF

Example

TRIG:SEQ1:COUNT 10

This command sets the number of triggered events to 10 for the channel A measurement cycle.

Reset Condition

On reset, the value is set to 1.

Query

```
TRIGger [1] | 2 [:SEQuence [1] | 2] :COUNT?
```

The query returns the current setting of trigger events for a specified channel.

Query Example

```
TRIG:SEQ2:COUN?
```

This command queries the number of triggered events for the channel B measurement cycle.

Error Messages

If COUNT >1 when [SENSe[1]] |SENSe2:MRATe <character_data> is set to NORMAl or DOUBle, Error -221, “Settings Conflict” occurs.

TRIGger[:SEQuence[1]|2]:DELay:AUTO <boolean>

This command is used to determine whether or not there is a settling-time delay before a measurement is made.

When this command is set to:

- ON, the power meter inserts a settling-time delay before taking the requested measurement and for subsequent measurements. This settling time allows the internal digital filter to be updated with new values to produce valid, accurate measurement results. The trigger with delay command allows settling time for the internal amplifiers and filters. It does not allow time for power sensor delay.

In cases of large power changes, the delay may not be sufficient for complete settling. Accurate readings can be assured by taking two successive measurements for comparison.

- OFF, no settling-time delay is inserted and the power meter makes the measurement immediately a trigger is received.
- ONCE, a settling-time delay is inserted before taking the requested measurement, for one measurement only.

TRIGger [1] | 2 :DELay:AUTO is ignored if TRIGger [1] | 2 [:IMMEDIATE] is set to ON.

Syntax

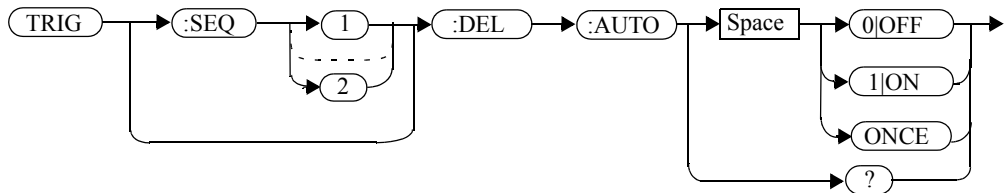

Example

TRIG:SEQ:DEL:AUTO ON

This command enables a delay on channel A.

Reset Condition

On reset, TRIGger:DELay:AUTO is set to ON.

TRIGger Subsystem
TRIGger[:SEQuence[1]|2]:DELay:AUTO <boolean>

Query

TRIGger:DELay:AUTO?

The query enters a 1 or 0 into the output buffer indicating the status of TRIGger:DELay:AUTO.

- 1 is returned when it is ON.
- 0 is returned when it is OFF.

Query Example

TRIG:SEQ2:DEL:AUTO?

This command queries the settling-time delay of channel B.

TRIGger[:SEquence[1][2]:IMMEDIATE

This command provides a one time over-ride of the normal process of the downward path through the wait for trigger state. It causes the immediate exit of the event detection layer if the trigger system is in this layer when the command is received. In other words, the instrument stops waiting for a trigger and takes a measurement ignoring any delay set by TRIG:DElay.

Syntax

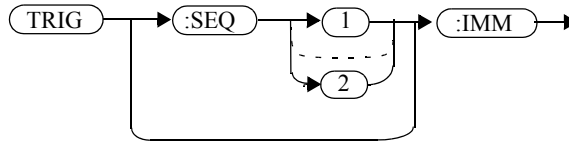

Example

TRIG:SEQ:IMM

This command initiates a measurement on channel A.

TRIGger[:SEQuence[1]|2]:SOURce BUS|EXTErnal|HOLD|IMMEdiate|INTErnal[[1]|2]

This command configures the trigger system to respond to the specified source. This command only selects the trigger source. Use the INITiate command to place the power meter in the wait for trigger state.

Note This command has the same purpose as
 TRIGger [1] | 2 : SOURce
 BUS | EXTErnal | HOLD | IMMEdiate | INTErnal [[1] | 2]

Syntax

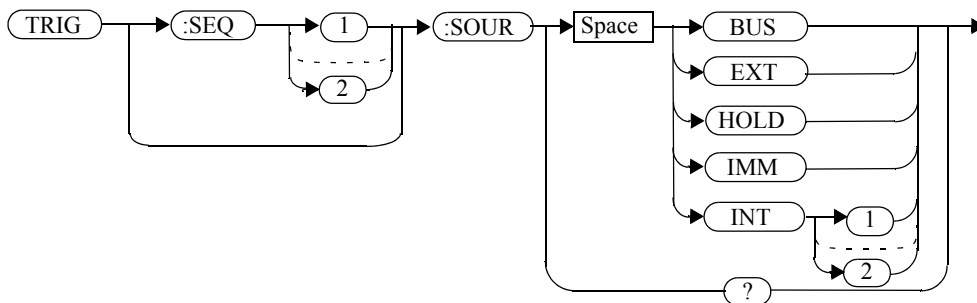

Parameters

Item	Description/Default	Range of Values
source	Available trigger sources: <ul style="list-style-type: none"> BUS: the trigger source is the group execute trigger <GET> bus command, a *TRG common command or the TRIGGER:IMMEdiate SCPI command. EXTErnal: the trigger source is the trigger input in the back panel. HOLD: triggering is suspended. The only way to trigger the power meter is to use TRIGger:IMMEdiate. IMMEdiate: the trigger system is always true. If INITiate:CONTInuous is ON the power meter is continually triggering free (free run mode). If an INITiate:IMMEdiate command is sent a measurement is triggered then the power meter returns to the idle state. INTErnal: either INT1 (channel A) or INT2 (channel B). 	BUS EXTErnal HOLD IMMEdiate INTErnal [[1] 2]

Note

The trigger source is set to IMMEDIATE on instrument power-up and when entering local mode.

The MEASure and CONFIgure commands automatically set the trigger source to IMMEDIATE.

The READ? or MEASure commands should not be used if the trigger source is set to BUS or HOLD.

Example

```
TRIG:SOUR IMM
```

This command configures channel A for immediate triggering.

Reset Condition

On reset, the trigger source is set to IMMEDIATE.

Query

```
TRIGger[:SEQuence[1]|2]:SOURce?
```

The query returns the current trigger source.

Query Example

```
TRIG:SEQ1:SOUR?
```

This command queries the current trigger source for channel A.

Error Messages

- For dual channel power meters: if the master is changed to IMM, BUS or HOLD, error -221 “Settings Conflict” occurs. In such situations the slave’s TRIG:SOUR must be changed so that it is no longer a slave.
- If the source is changed to INT1, INT2 or EXT and SENS:SPEED has a value of 200, error -221 “Settings Conflict” occurs.
- If the source is changed to INT1, INT2 or EXT and SENS:DET:FUNC is set to AVERAGE, error -221 “Settings Conflict” occurs.

THIS PAGE HAS BEEN INTENTIONALLY LEFT BLANK.

14

———— **UNIT Subsystem**

UNIT Subsystem

The UNIT command subsystem:

- Sets power measurement units to dBm or Watts.
- Sets measurement ratio units to dB or % (linear).

Both UNIT commands have a numeric suffix which determines which window/measurement is set:

- UNIT1: units are set for the upper window/upper measurement.
- UNIT2: units are set for the lower window/upper measurement.
- UNIT3: units are set for the upper window/lower measurement.
- UNIT4: units are set for the lower window/lower measurement.

The following commands are described in this section:

Keyword	Parameter Form	Notes	Page
UNIT[1] 2 3 4			
:POWer	<amplitude unit>		page 14-3
:RATio	<ratio_unit>	[non-SCPI]	page 14-6

The UNIT:POWer and UNIT:POWer:RATio commands are coupled as follows:

- If UNIT:POWer is set to dBm then UNIT:POWer:RATio is dB.
- If UNIT:POWer is set to W then UNIT:POWer:RATio is %.

UNIT[1]2|3|4:POWer <amplitude_unit>

This command sets the power measurement units for a specified window/measurement. The power suffix set by `UNIT : POWer` is used for any command which accepts a numeric value in more than one unit

For the E4416A:

- `UNIT1 : POWer` sets the power measurement units for the upper window/upper measurement.
- `UNIT2 : POWer` sets the power measurement units for the lower window/upper measurement.
- `UNIT3 : POWer` sets the power measurement units for the upper window/lower measurement.
- `UNIT4 : POWer` sets the power measurement units for the lower window/lower measurement.

For ratio and relative power measurements:

- If `UNIT : POWer` is `W`, the measurement units are percentage.
- If `UNIT : POWer` is `DBM`, the measurement units are dB relative.

Syntax

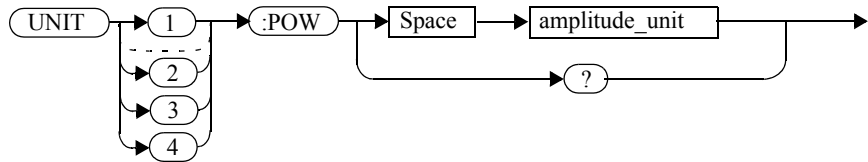

Parameters

Item	Description/Default	Range of Values
amplitude_unit	The measurement unit. <ul style="list-style-type: none"> • The default unit is dBm. 	W DBM

Example

```
UNIT1:POW DBM
```

This command sets the power measurement units for the upper window/upper measurement.

Reset Condition

On reset, all windows/measurements are set to DBM.

Query

```
UNIT[1] | 2 | 3 | 4 : POWer?
```

The query returns the current setting of the power measurement units.

Query Example

```
UNIT2 : POW?
```

This command queries which measurement units are being used on the lower window/upper measurement.

UNIT[1|2|3|4]:POWer:RATio <ratio_unit>

This command sets the window/measurement ratio units.

- UNIT1:POWer:RATio sets the ratio measurement units for the upper window/upper measurement.
- UNIT2:POWer:RATio sets the ratio measurement units for the lower window/upper measurement.
- UNIT3:POWer:RATio sets the ratio measurement units for the upper window/lower measurement.
- UNIT4:POWer:RATio sets the ratio measurement units for the lower window/lower measurement.

Syntax

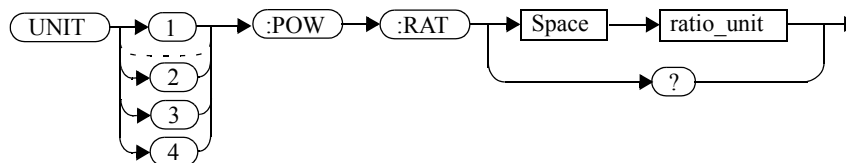

Parameters

Item	Description/Default	Range of Values
ratio_unit	The ratio measurement unit. The default unit is DB.	DB PCT

Example

UNIT1:POW:RAT DB

This command sets the ratio measurement units for the upper window/upper measurement.

Reset Condition

On reset, the value is set to DB.

Query

```
UNIT[1]|2|3|4:POWer:RATio?
```

The query returns the current setting of the ratio measurement units.

Query Example

```
UNIT2:POW:RAT?
```

This command queries which ratio measurement units are being used on the lower window/upper measurement.

UNIT Subsystem
UNIT[1]|2|3|4:POWer:RATio <ratio_unit>

THIS PAGE HAS BEEN INTENTIONALLY LEFT BLANK.

15

———— **SERVice Subsystem**

SERVICE Subsystem

The SERVICE command subsystem is used to load information such as the power meter processor board revision version and obtain information such as the serial number of the current sensor(s) being used.

Keyword	Parameter Form	Notes	Page
SERVICE			
:BIST			
:CALibrator	<boolean>		page 15-3
:FPATH[1] 2			
:MEASure?		[query only]	
:REFerence	<numeric_value>	[no query]	
:STATe	<boolean>	[no query]	
:TBASe			
:STATe	<boolean>		page 15-6
:TRIG			
:LEVel			
:STATe?		[query only]	page 15-8
:TEST?		[query only]	page 15-9
:OPTion	<character_data>		page 15-10
:SENSor[1] 2			
:CALFactor	<cal_factor_data>		page 15-11
:CDATe?		[query only]	page 15-13
:CORRections			
:STATe	<boolean>		page 15-14
:CPLace?		[query only]	page 15-14
:FREQuency			
:MAXimum?		[query only]	page 15-17
:MINimum?		[query only]	page 15-18
:PCALfactor	<cal_factor_data>		page 15-19
:POWER			
:AVERAge			
:MAXimum?		[query only]	page 15-20
:PEAK			
:MAXimum?		[query only]	page 15-21
:USABle			
:MAXimum?		[query only]	page 15-22
:MINimum?		[query only]	page 15-23
:RADc?		[query only]	page 15-24
:SNUMber?		[query only]	page 15-25
:TNUMber?		[query only]	page 15-26
:TYPE?		[query only]	page 15-27
:SNUMber	<character_data>		page 15-28
:VERSion			
:PROcessor	<character_data>		page 15-29
:SYSTem	<character_data>		page 15-30

SERvice:BIST:CALibrator <boolean>

This command enables/disables the calibrator self-test during power-up. It can be used to disable the self-test if it incorrectly indicates failure—for example a long sensor cable may cause an incorrect failure.

Syntax

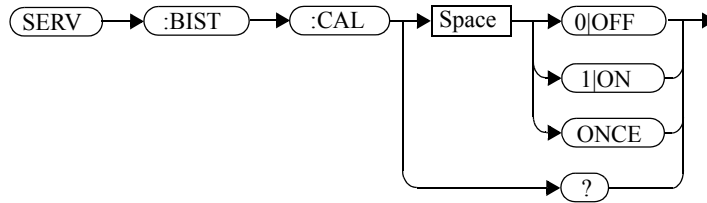

Example

SERV:BIST:CAL OFF

This command disables the calibrator self-test during power-up.

Reset Condition

On reset, the value is set to OFF.

Query

SERvice:BIST:CALibrator?

The query enters a 1 or 0 into the output buffer indicating the status of the self-test.

- 1 is returned when the self-test is enabled.
- 0 is returned when the self-test is disabled.

Query Example

SERV:BIST:CAL?

This command queries whether the self-test is enabled or disabled.

SERvice:BIST:FPATH[1]2:MEASure?

This query returns the power measured by the meter as a DC voltage, for the specified channel. It applies to E9320 Series power sensors only.

Note Additional hardware is needed to run this command. For further information refer to the power meter *Service Guide*.

Syntax

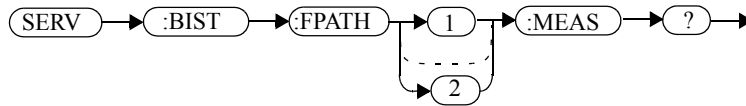

Example

SERV:BIST:FPATH:MEAS?

This command queries DC voltage measured by the power meter on channel A.

Error Messages

- If no power sensor is connected, error -241 “Hardware missing” occurs.
- If a non E9320 Series power sensor is connected, error -241 “Hardware missing” occurs.
- If FPATH2 is sent to a single channel meter, error -113 “Undefined header” occurs.

SERVice:BIST:FPATH[1]2:REFerence <numeric_value>

This command enters an externally measured sensor DC voltage at 0.0 dBm for use as a reference, for the specified channel. It applies to E9320 Series power sensors only.

Note Additional hardware is needed to run this command. For further information refer to the power meter *Service Guide*.

Syntax

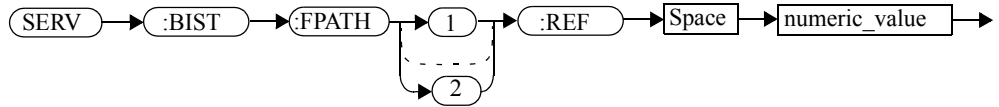

Parameters

Item	Description/Default	Range of Values
numeric_value	An externally measured DC voltage when 0.0 dBm is applied to the sensor.	0.1 to 2.4 v

Example

`SERV:BIST:FPATH2:REF 1.2` *This command enters an externally measured sensor voltage of 1.2 v DC to be used as a reference, for channel B.*

Reset Condition

On reset, the last entered value is retained.

Error Messages

- If no power sensor is connected, error -241 “Hardware missing” occurs.
- If a non E9320 Series power sensor is connected, error -241 “Hardware missing” occurs.
- If FPATH2 is sent to a single channel meter, error -113 “Undefined header” occurs.

SERVICE:BIST:FPATH[1]2:STATE <boolean>

This command enables/disables fast path accuracy test mode for the specified channel. It applies to E9320 Series power sensors only.

Note Additional hardware is needed to run this command. For further information refer to the power meter *Service Guide*.

After using this command, a system preset is recommended.

If the command is set to:

- ON, fast path accuracy test mode is enabled for the specified channel.
- OFF, fast path accuracy test mode is disabled for the specified channel.

Syntax

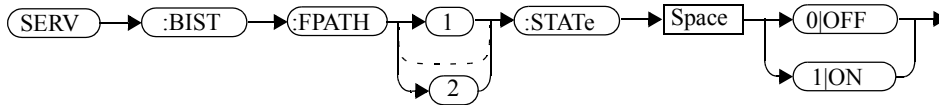

Example

`SERV:BIST:FPATH:STATE OFF` *This command disables fast path accuracy test mode for channel A.*

Reset Condition

On reset, test mode is disabled.

Error Messages

- If no power sensor is connected, error -241 “Hardware missing” occurs.
- If a non E9320 Series power sensor is connected, error -241 “Hardware missing” occurs.
- If FPATH2 is sent to a single channel meter, error -113 “Undefined header” occurs.

SERVICE:BIST:TBASe:STATe <boolean>

This command sends a 10 MHz time base signal to the rear panel trig out for testing purposes.

If the command is set to:

- ON, the 10 MHz time base signal is sent to the rear panel trigger out connector.
- OFF, the 10 MHz time base signal is disabled.

Syntax

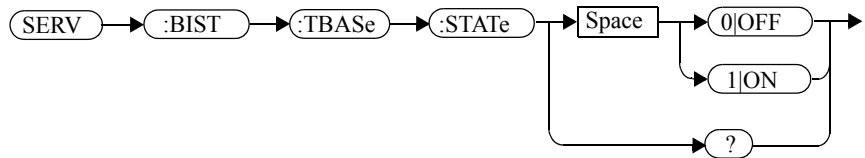

Example

`SERV:BIST:TBAS:STAT OFF` *This command disables the signal.*

Reset Condition

On reset, the signal is disabled.

Query

`SERVICE:BIST:TBASe:STAT?`

The query enters a 1 or 0 into the output buffer indicating the status of the 10 MHz time base testing.

- 1 is returned when the signal is enabled.
- 0 is returned when the signal is disabled.

Query Example

`SERV:BIST:TBASe:STAT?` *This command queries whether the test is enabled or disabled.*

SERvice:BIST:TRIGger:LEVel:STATe

This command queries trigger level.

- 1 is returned when the external trigger-in is high.
- 0 is returned when the external trigger-in is low.

Syntax



Example

SERV:BIST:TRIG:LEV:STAT?

This command queries trigger level.

SERvice:BIST:TRIGger:TEST?

This command queries trigger in and out.

- 1 is returned if the test passes.
- 0 is returned if the test fails.

Note

Before running this command, the read panel trigger out must be jumpered to the rear panel trigger in.

Syntax



Example

SERV:BIST:TRIG:TEST?

This command queries trigger in and out.

SERvice:OPTion <character_data>

This command loads the power meter memory with the options fitted. The query form of the command can be used to determine which options are fitted to the unit.

Syntax

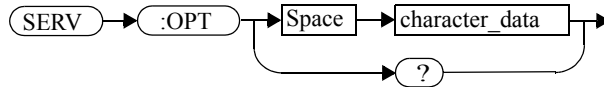

Parameters

Item	Description/Default	Range of Values
character_data	Details the option number in a comma separated list. A maximum of 30 characters can be used.	A to Z (uppercase) a to z (lowercase) 0 - 9 _ (underscore)

Example

```
SERV:OPT "002"
```

This command loads the power meter memory with 002 indicating that the unit is fitted with a rear panel sensor input.

Query

```
SERvice:OPTion?
```

The query returns the current option string. For example, if the string "003" is returned, the power meter is fitted with a sensor input and power reference on the back panel.

SERvice:SENSor[1]|2:CALFactor <cal_factor_data>

This command writes calibration factor data to, or reads calibration factor data from, the currently connected sensor. The whole calibration factor block must be written at once as a checksum is generated. The new block must not be larger than the existing block.

This command applies to the following sensors:

- E4410 Series.
- N8480 Series (excluding Option CFT)
- E9300 Series.
- E9320 Series, average path data.

For E9320 Series sensors, peak path, refer to
SERvice:SENSor[1]|2:PCALFactor <cal_factor_data>.

Syntax



Parameters

Item	Description/Default
cal_factor_data	A binary data block. Refer to Appendix A for further information.

Query

SERvice:SENSor[1]|2:CALFactor?

The query returns the current calibration factor block.

Query Example

SERV : SENS : CALF ?

This command returns the calibration factor block for channel A.

Error Messages

- If no power sensor is connected, error -241 “Hardware missing” occurs.
- If a non E-Series sensor or N8480 Series sensor with Option CFT is connected, error -241 “Hardware missing” occurs.
- If an E9320 Series sensor is connected and SERVICE:SENSOR[1]2:CORRECTIONS:STATE is set to ON, error -221, “Settings conflict” occurs.
- If INIT:CONT is not set to OFF, error -221, “Settings conflict” occurs.

SERvice:SENSor[1]|2:CDATe?

This query returns the calibration date in **E-Series and N8480 Series sensors**. Calibration date information is stored in the sensor's EEPROM.

Syntax

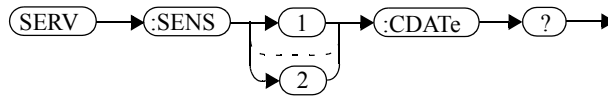

Example

SERV : SENS2 : CDATe?

This query returns the calibration date of the E-Series or N8480 Series sensor connected to channel B.

Error Messages

- If no power sensor is connected, error -241 “Hardware missing” occurs.
- If a non E-Series N8480 Series sensor is connected, error -241 “Hardware missing” occurs.

SERVICE:SENSOR[1]|2:CORRECTIONS:STATE <boolean>

This command enables/disables the voltage to corrected power conversion. It applies to E9320 Series power sensors only.

Note Before setting this command to OFF, you must set the INIT:CONF command to OFF.

After setting this command to OFF, you must only run commands relating to the gathering of ADC values—for example, the SERV:SENS:RADC command.

Syntax

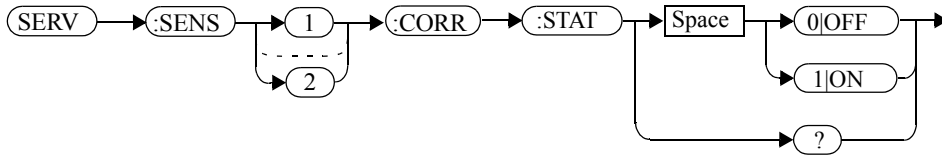

Example

```
SERV:SENS2:CORR:STAT ON
```

This command enables the voltage to corrected power conversion for channel B.

Reset Condition

On reset, the value is set to OFF.

Query

```
SERVICE:SENSOR[1]|2:CORRECTIONS:STATE?
```

The query enters a 1 or 0 into the output buffer indicating the status of the voltage to corrected power conversion.

- 1 is returned when voltage to corrected power conversion is enabled.
- 0 is returned when voltage to corrected power conversion is disabled.

Query Example

SERV:SENS:CORR:STAT?

This command queries whether voltage to corrected power conversion is enabled for channel A.

Error Messages

- If INIT:CONT is not set to off, error -221, “Settings conflict” occurs.
- If a non E9320 Series sensor is connected, error -241, “Hardware missing” occurs.

SERvice:SENSor[1]|2:CPLace?

This query returns the calibration place in E-Series and N8480 Series sensors. Calibration place information is stored in the sensor's EEPROM.

Syntax

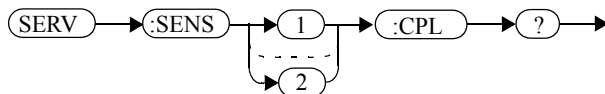

Example

SERV : SENS2 : CPL?

This query returns the place of calibration of the E-Series or N8480 Series sensor connected to channel B.

Error Messages

- If no power sensor is connected, error -241 “Hardware missing” occurs.
- If a non E-Series or N8480 Series sensor is connected, error -241 “Hardware missing” occurs.

SERvice:SENSor[1]|2:FREQuency:MAXimum?

This query returns the maximum frequency that can be measured by the currently connected sensor. It is applicable to E-Series sensors only. Maximum frequency information is stored in the sensor's EEPROM.

Syntax

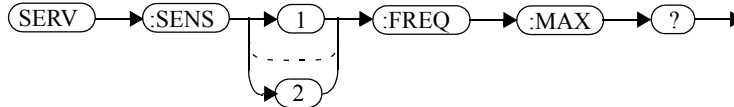

Example

SERV : SENS2 : FREQ : MAX?

This query returns the maximum frequency that can be measured by the E-Series sensor currently connected to channel B.

Error Messages

- If no sensor is connected, error -241, “Hardware missing” occurs.
- If a non E-Series is connected, error -241 “Hardware missing” occurs.
- If the E-Series sensor currently connected does not contain the necessary information in EEPROM, error -241 “Hardware missing” occurs.

SERVICE:SENSOR[1]2:FREQUENCY:MINIMUM?

This query returns the minimum frequency that can be measured by the currently connected sensor. It is applicable to E-Series sensors only. Minimum frequency information is stored in the sensor's EEPROM.

Syntax

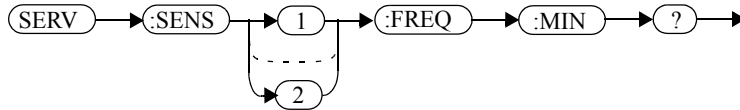

Example

```
SERV : SENS1 : FREQ : MIN?
```

This query returns the minimum frequency that can be measured by the E-Series sensor currently connected to channel A.

Error Messages

- If no sensor is connected, error -241, “Hardware missing” occurs.
- If a non E-Series is connected, error -241 “Hardware missing” occurs.
- If the E-Series sensor currently connected does not contain the necessary information in EEPROM, error -241 “Hardware missing” occurs.

SERvice:SENSor[1]2:PCALfactor <cal_factor_data>

This command writes calibration factor data to, or reads calibration factor data from, the currently connected sensor. The whole calibration factor block must be written at once as a checksum is generated. The new block must not be larger than the existing block.

This command applies to E9320 Series sensors for peak path data only. For E4410 Series, E9300 Series, and E9320 Series sensors, average path data, refer to `SERvice:SENSor[1]2:CALFactor <cal_factor_data>`.

Syntax



Parameters

Item	Description/Default
cal_factor_data	A binary data block. Refer to Appendix A for further information.

Query

`SERvice:SENSor[1]2:PCALfactor?`

The query returns the current peak path calibration factor block.

Query Example

`SERV:SENS:PCALf?`

This command returns the peak path calibration factor block for channel A.

Error Messages

- If no power sensor is connected, error -241 “Hardware missing” occurs.
- If a non E9320 Series sensor is connected, error -241 “Hardware missing” occurs.
- If `INIT:CONT` is not set to `OFF`, error -221, “Settings conflict” occurs.

SERvice:SENSor[1]|2:POWer:AVERage:MAXimum?

This query returns the maximum average power that can be measured by the currently connected sensor. It is applicable to E-Series sensors only. Maximum average power information is stored in the sensor's EEPROM.

Syntax

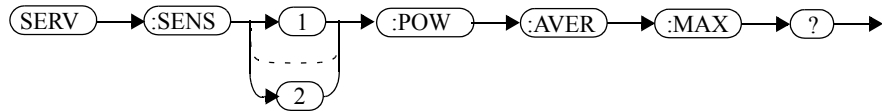

Example

SERV : SENS : POW : AVER : MAX ?

This query returns the maximum average power that can be measured by the E-Series sensor currently connected to channel A.

Error Messages

- If no sensor is connected, error -241, “Hardware missing” occurs.
- If a non E-Series is connected, error -241 “Hardware missing” occurs.
- If the E-Series sensor currently connected does not contain the necessary information in EEPROM, error -241 “Hardware missing” occurs.

SERvice:SENSor[1]2:POWer:PEAK:MAXimum?

This query returns the maximum peak power that can be measured by the currently connected sensor. It is applicable to E-Series sensors only. Maximum peak power information is stored in the sensor's EEPROM.

Syntax

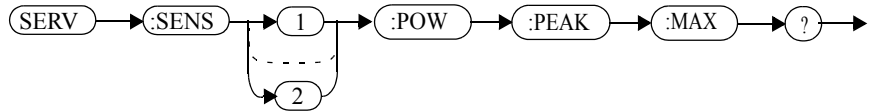

Example

SERV : SENS2 : POW : PEAK : MAX?

This query returns the maximum peak power that can be measured by the E-Series sensor currently connected to channel B.

Error Messages

- If no sensor is connected, error -241, “Hardware missing” occurs.
- If a non E-Series is connected, error -241 “Hardware missing” occurs.
- If the E-Series sensor currently connected does not contain the necessary information in EEPROM, error -241 “Hardware missing” occurs.

SERvice:SENSor[1]2:POWer:USABle:MAXimum?

This query returns the maximum power that can be accurately measured by the currently connected sensor. It is applicable to E-Series sensors only. Maximum power information is stored in the sensor's EEPROM.

Syntax

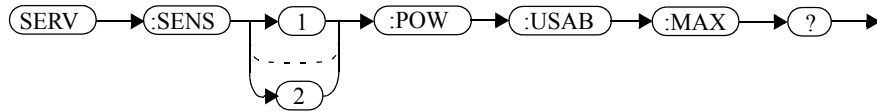

Example

SERV : SENS1 : POW : USAB : MAX?

This query returns the maximum power that can be accurately measured by the E-Series sensor currently connected to channel A.

Error Messages

- If no sensor is connected, error -241, “Hardware missing” occurs.
- If a non E-Series is connected, error -241 “Hardware missing” occurs.
- If the E-Series sensor currently connected does not contain the necessary information in EEPROM, error -241 “Hardware missing” occurs.

SERvice:SENSor[1]2:POWer:USABle:MINimum?

This query returns the minimum power that can be accurately measured by the currently connected sensor. It is applicable to E-Series sensors only. Maximum power information is stored in the sensor's EEPROM.

Syntax

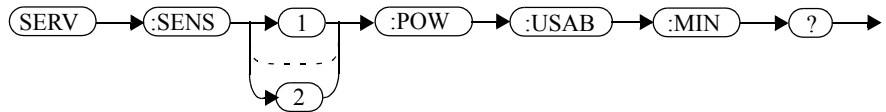

Example

```
SERV : SENS : POW : USAB : MIN?
```

This query returns the minimum power that can be accurately measured by the E-Series sensor currently connected to channel A.

Error Messages

- If no sensor is connected, error -241, “Hardware missing” occurs.
- If a non E-Series is connected, error -241 “Hardware missing” occurs.
- If the E-Series sensor currently connected does not contain the necessary information in EEPROM, error -241 “Hardware missing” occurs.

SERVICE:SENSOR[1]2:RADC?

This query returns a new raw uncorrected measurement in volts, as a 32 bit signed integer.

Note

For E9320 Series sensors:
before running this query, the voltage to corrected power conversion must be disabled using the `SERVICE:SENSOR[1]2:CORRECTIONS:STATE` command.

Syntax

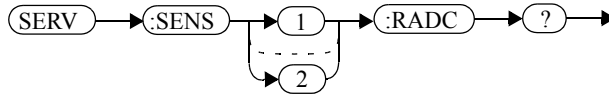

Example

`SERV:SENS2:RADC?`

This query returns a new raw uncorrected measurement for the sensor connected to channel B.

Error Messages

- If `INIT:CONT` is set to ON, error -221 “Settings Conflict” occurs.
- If an E9320 Series sensor is connected and `SERVICE:SENSOR[1]2:CORRECTIONS:STATE` is set to ON, error -221 “Settings Conflict” occurs.

SERvice:SENSor[1]|2:SNUMber?

This query returns the serial number for E-Series and N8480 Series sensors. Serial number information is stored in the sensor's EEPROM.

Syntax

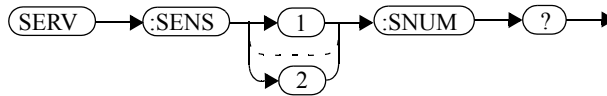

Example

SERV : SENS2 : SNUM?

This query returns the serial number of the E-Series or N8480 Series sensor connected to channel B.

Error Messages

- If no sensor is connected, error -241, “Hardware missing” occurs.
- If a non E-Series or N8480 Series sensor is connected, error -241 “Hardware missing” occurs.

SERvice:SENSor[1]2:TNUMber?

This query returns the tracking number for E-Series sensors. Tracking number information is stored in the sensor's EEPROM.

Syntax

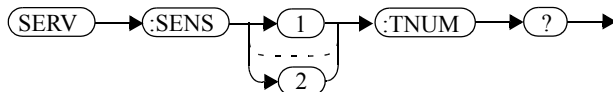

Example

SERV : SENS2 : TNUM?

This query returns the serial number of the E-Series sensor connected to channel B.

Error Messages

- If no sensor is connected, error -241, “Hardware missing” occurs.
- If a non E-Series sensor is connected, error -241 “Hardware missing” occurs.

SERvice:SENSor[1]2:TYPE?

This query identifies the sensor type connected to the power meter input channel(s). For Agilent 8480 Series sensors, either “A”, “B”, “D”, or “H” is returned. For E-Series and N8480 Series sensors, the model number stored in EEPROM is returned.

Syntax

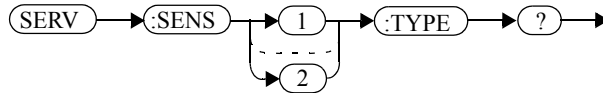

Example

SERV : SENS2 : TYPE?

This query returns either, “A”, “B”, “D”, or “H” if an Agilent 8480 Series sensor is connected to channel B, or the sensor model number if an E-Series or N8480 Series sensor is connected to channel B.

Error Messages

- If no sensor is connected, error -241, “Hardware missing” occurs.

SERVICE:SNUMBER <character_data>

This command loads the power meter with a serial number in the form GB12345678 or US12345678.

Syntax

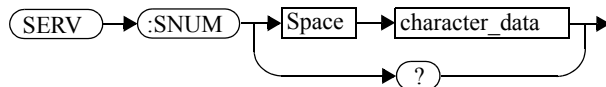

Parameters

Item	Description/Default	Range of Values
character_data	Details the power meter serial number in the form GB12345678 or US12345678. A maximum of 30 characters can be used.	A to Z (uppercase) a to z (lowercase) 0 - 9

Example

```
SERV:SNUM GB12345678
```

This command loads the power meter with the serial number GB12345678.

Query

```
SERVICE:SNUMBER?
```

The query returns the power meter serial number in the form GB12345678 or US12345678.

SERvice:VERsion:PROcessor <character_data>

This command loads the power meter with the processor board revision version.

Syntax

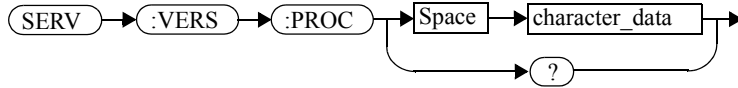

Parameters

Item	Description/Default	Range of Values
character_data	Details the processor board revision version. A maximum of 20 characters can be used.	A to Z (uppercase) a to z (lowercase) 0 - 9 _ (underscore)

Example

SERV:VERS:PROC "C"

This command loads the power meter with processor board revision version C.

Query

SERvice:VERsion:PROcessor?

The query returns the current processor board revision version.

SERvice:VERSion:SYSTem <character_data>

This command loads the power meter with the system version number.

Syntax

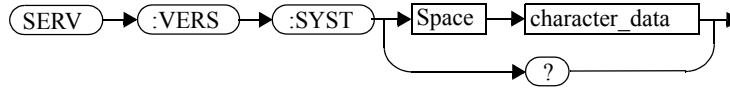

Parameters

Item	Description/Default	Range of Values
character_data	Details the system version number. A maximum of 20 characters can be used.	A to Z (uppercase) a to z (lowercase) 0 - 9 _ (underscore)

Example

```
SERV:VERS:SYST "1"
```

This command loads the power meter with system version number 1.

Query

```
SERvice:VERSion:SYSTem?
```

The query returns the current power meter system version number.

IEEE-488 Compliance Information

This chapter contains information about the IEEE 488.2 Common (*) Commands that the power meter supports. It also describes the universal command statements which form the nucleus of GPIB programming; they are understood by all instruments in the network. When combined with programming language codes, they provide all management and data communication instructions for the system.

The command descriptions are in alphabetical order.

IEEE-488.2 Common Commands

*CLS	Clear Status	page 16-6
*DDT	Define Device Trigger	page 16-7
*DDT?	Define Device Trigger	page 16-7
*ESE	Event Status Enable	page 16-9
*ESE?	Event Status Enable	page 16-9
*ESR?	Event Status Register	page 16-10
*IDN?	Identify	page 16-11
*OPC	Operation Complete	page 16-12
*OPC?	Operation Complete	page 16-12
*OPT?	Options	page 16-13
*RCL	Recall	page 16-14
*RST	Reset	page 16-15
*SAV	Save	page 16-16
*SRE	Service Request Enable	page 16-17
*SRE?	Service Request Enable	page 16-17
*STB?	Status Byte	page 16-19
*TRG	Trigger	page 16-21
*TST?	Test	page 16-22
*WAI	Wait	page 16-23

Universal Commands

DCL

The DCL (Device Clear) command causes all GPIB instruments, or addressed instruments, to assume a cleared condition. The definition of device clear is unique for each instrument. For the power meter:

- All pending operations are halted, that is, *OPC? and *WAI.
- The parser (the software that interprets the programming codes) is reset and now expects to receive the first character of a programming code.
- The output buffer is cleared.

GET

The GET (Group Execute Trigger) command triggers all channels that are in the “wait-for-trigger” state.

Using the *DDT command may change the function of the GET command.

Error Message

If TRIGger : SOURce is not set to BUS then error -211, “Trigger ignored” occurs.

If the power meter is not in the “wait-for-trigger” state then error -211, “Trigger ignored” occurs.

GTL

The GTL (Go To Local) command is the complement to remote. It causes the power meter to return to local control with a fully enabled front panel. When reverting to local mode the power meter triggering is set to free run.

LLO

The LLO (Local Lock Out) command can be used to disable the front panel local key. With this key disabled, only the controller (or a hard reset by the line power switch) can restore local control.

PPC

When addressed to listen, the PPC (Parallel Poll Configure) command will cause the power meter to be configured according to the parallel poll enable secondary command which should follow this command.

PPD

Sending the PPC command followed by the PPD (Parallel Poll Disable) command will disable the power meter from responding to a parallel poll. This is effectively a selective disable.

Table 0-26: PPD Mapping

Bit	Weight	Meaning
0	1	Always 0
1	2	Always 0
2	4	Always 0
3	8	Always 0
4	16	Always 1
5	32	Always 1
6	64	Always 1
7	128	Always 0

PPE

Once the power meter has received a PPC command, the PPE (Parallel Poll Enable) secondary command configures the power meter to respond to a parallel poll on a particular data line with a particular level.

Table 0-27: PPE Mapping

Bit	Weight	Meaning
0	1	Bit positions for response: 000 (bit 0), 001 (bit 1), 010 (bit 2), 011 (bit 3), 100 (bit 4), 101 (bit 5), 110 (bit 6), 111 (bit 7)
1	2	
2	4	

Bit	Weight	Meaning
3	8	Sense bit 0 - response bit is cleared during a parallel poll if requesting service 1 - response bit is set during a parallel poll if requesting service
4	16	Always 0
5	32	Always 1
6	64	Always 1
7	128	Always 0

PPU

The PPU (Parallel Poll Unconfigure) command disables the power meter from responding to a parallel poll. This is effectively a universal disable.

SDC

The SDC (Selected Device Clear) command causes all GPIB instruments in the listen state, to assume a cleared condition. The definition of a selected device clear is unique for each instrument. For the power meter:

- All pending operations are halted, that is, *OPC? and *WAI.
- The parser (the software that interprets the programming codes) is reset and now expects to receive the first character of a programming code.
- The output buffer is cleared.

SPD

The SPD (Serial Poll Disable) command terminates the serial poll mode for the power meter and returns it to its normal talker state where device dependent data is returned rather than the status byte.

SPE

The SPE (Serial Poll Enable) command establishes the serial poll mode for the power meter. When the power meter is addressed to talk, a single eight bit status byte is returned.

***CLS**

***CLS**

The `*CLS` (Clear Status) command clears the status data structures. The SCPI registers (Questionable Status, Operation Status and all the other SCPI registers), the Standard Event Status Register, the Status Byte, and the Error/Event Queue are all cleared.

Syntax

`*CLS` →

***DDT <arbitrary block program data>|<string program data>**

The *DDT (Define Device Trigger) command determines the power meter's response to a GET (Group Execute Trigger) message or *TRG common command. This command effectively turns GET and *TRG into queries, with the measured power being returned.

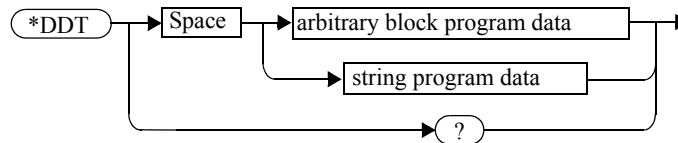
Syntax**Parameters**

Type	Description	Range of Values
arbitrary block program data	The command which is executed on a GET or *TRG.	#nN<action> ^{1,2}
string program data		"<action>" ¹

1. The <action> field of the parameter may contain:

- FETC?
- FETC1?
- FETC2? (E4417A only)
- *TRG
- TRIG1
- TRIG2 (E4417A only)

2. The first digit after the # indicates the number of following digits. The following digits indicate the length of the data.

Examples of <arbitrary block program data> parameters are:

- #15FETC? and #206FETCh?

Examples of <string program data> are:

- "FETCh1?", "FETCh?" and "TRIG1;FETC1"

Note

*DDT does not support "FETCh1?" and "FETCh2?" simultaneously.

***DDT <arbitrary block program data>|<string program data>**

Reset Condition

On reset, the <action> field of *DDT is set to *TRG.

Query

*DDT?

The query returns the action which is performed on receipt of a GET or *TRG. This is returned as a <definite length arbitrary block response data> value which is in the form of #nN<action> as described on page 16-7.

Error Message

- If an invalid parameter is received, error -224, “Illegal parameter value” occurs.

***ESE <NRf>**

The *ESE (Event Status Enable) <NRf> command sets the Standard Event Status Enable Register. This register contains a mask value for the bits to be enabled in the Standard Event Status Register. A 1 in the Enable Register enables the corresponding bit in the Status Register, a 0 disables the bit. The parameter value, when rounded to an integer and expressed in base 2, represents the bit values of the Standard Event Status Enable Register. Table 0-28 shows the contents of this register.

Table 0-28: *ESE Mapping

Bit	Weight	Meaning
0	1	Operation Complete
1	2	Request Control (not used)
2	4	Query Error
3	8	Device Dependent Error
4	16	Execution Error
5	32	Command Error
6	64	Not used
7	128	Power On

Syntax

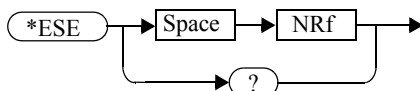

Parameters

Type	Description/Default	Range of Values
NRf	A value used to set the Standard Event Status Enable Register.	0 - 255

Query

*ESE?

The query returns the current contents of the Standard Event Status Enable Register. The format of the return is <NR1> in the range of 0 to 255.

*ESR?

The *ESR? query returns the contents of the Standard Event Status Register then clears it. The format of the return is <NR1> in the range of 0 to 255. Table 0-29 shows the contents of this register.

Table 0-29: *ESR? Mapping

Bit	Weight	Meaning
0	1	Operation Complete
1	2	Request Control (not used)
2	4	Query Error
3	8	Device Dependent Error
4	16	Execution Error
5	32	Command Error
6	64	Not used
7	128	Power On

Syntax

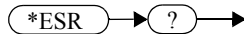

***IDN?**

The *IDN? query allows the power meter to identify itself. The string returned will be either:

```
Agilent Technologies,E4416A,<serial number>,A1.XX.YY
```

```
Agilent Technologies,E4417A,<serial number>,A2.XX.YY
```

where:

- <serial number> uniquely identifies each power meter.
- A1.XX.YY and A2.XX.YY represents the firmware revision with XX and YY representing the major and minor revisions respectively.

Syntax

***OPC**

***OPC**

The *OPC (Operation Complete) command causes the power meter to set the operation complete bit in the Standard Event Status Register when all pending device operations have completed.

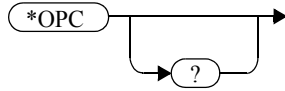
Syntax**Query**

*OPC?

The query places an ASCII 1 in the output queue when all pending device operations have completed.

***OPT?**

The *OPT? query reports the options installed in the power meter and returns:

- " " empty string for a standard instrument.
- "002" for an option 002 instrument.
- "003" for an option 003 instrument.

Syntax

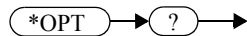

***RCL <NRf>**

The ***RCL <NRf>** (ReCaLI) command restores the state of the power meter from the specified save/recall register. An instrument setup must have been stored previously in the specified register.

Syntax

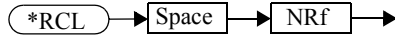

Parameters

Type	Description/Default	Range of Values
NRf	The number of the register to be recalled.	1 - 10

Error Message

- If the register does not contain a saved state, error -224, “Illegal parameter value” occurs.

***RST**

The *RST (ReSeT) command places the power meter in a known state. Refer to chapter 11 for information on reset values.

Syntax

`*RST` →

***SAV <NRf>**

***SAV <NRf>**

The *SAV <NRf> (SAVe) command stores the current state of the power meter in the specified register.

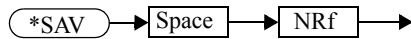
Syntax**Parameters**

Item	Description/Default	Range of Values
NRf	The number of the register that the current state of the power meter is to be saved to.	1 - 10

***SRE <NRf>**

The *SRE <NRf> command sets the Service Request Enable register bits. This register contains a mask value for the bits to be enabled in the Status Byte Register. A 1 in the Enable Register enables the corresponding bit in the Status Byte Register; a 0 disables the bit. The parameter value, when rounded to an integer and expressed in base 2, represents the bits 0 to 5 and bit 7 of the Service Request Enable Register. Bit 6 is always 0. Table 0-30 shows the contents of this register. Refer to the pullout at the end of chapter 1 for further information.

Table 0-30: *SRE Mapping

Bit	Weight	Meaning
0	1	Not used
1	2	Not used
2	4	Device Dependent
3	8	QUEStionable Status Summary
4	16	Message Available
5	32	Event Status Bit
6	64	Not used
7	128	OPERation Status Summary

Syntax

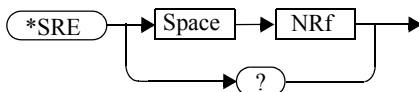

Parameters

Type	Description/Default	Range of Values
NRf	A value used to set the Service Request Enable Register.	0 - 255

***SRE <NRf>**

Query

*SRE?

The query returns the contents of bits 0 to 5 and bit 7 of the Service Request Enable Register. The format of the return is <NR1> in the ranges of 0 to 63 or 128 to 191 (that is, bit 6 is always 0).

***STB?**

The *STB? (Status Byte) query returns bit 0 to 5 and bit 7 of the power meter's status byte and returns the Master Summary Status (MSS) as bit 6. The MSS is the inclusive OR of the bitwise combination (excluding bit 6) of the Status Byte and the Service Request Enable registers. The format of the return is <NR1> in the ranges of 0 to 255. Table 0-31 shows the contents of this register. Refer to the pullout at the end of chapter 1 for further information.

Table 0-31: *STB? Mapping

Bit	Weight	Meaning
0	1	Not used
1	2	Device Dependent 0 - No device status conditions have occurred 1 - A device status condition has occurred
2	4	Error/Event Queue 0 - Queue empty 1 - Queue not empty
3	8	Questionable Status Summary 0 - No QUEStionable status conditions have occurred 1 - A QUEStionable status condition has occurred
4	16	Message Available 0 - no output messages are ready 1 - an output message is ready
5	32	Event Status Bit 0 - no event status conditions have occurred 1 - an event status condition has occurred
6	64	Master Summary Status 0 - power meter not requesting service 1 - there is at least one reason for requesting service
7	128	Operation Status Summary 0 - No OPERation status conditions have occurred 1 - An OPERation status condition has occurred

Syntax



***TRG**

The *TRG (TRiGger) command triggers all channels that are in the wait for trigger state. It has the same effect as Group Execute Trigger (GET).

Using the *DDT command may change the function of the *TRG command.

Syntax

 *TRG →

Error Message

- If TRIGger : SOURce is not set to BUS, error -211, “Trigger ignored” occurs.
- If the power meter is not in the wait-for-trigger state, error -211, “Trigger ignored” occurs.

***TST?**

***TST?**

The *TST? (TeST) query causes the power meter to perform the GPIB self test. The test takes approximately 30 seconds and consists of the following tests:

- ROM.
- RAM.
- Lithium battery.
- Display assembly.
- Calibrator.
- Measurement assembly channel A.
- Measurement assembly channel B (dual channel instruments only).
- Serial interface.

The result of the test is placed in the output queue.

- 0 is returned if the test passes.
- 1 if the test fails.

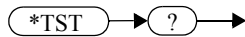
Syntax

***WAI**

The *WAI (WAI)t command causes the power meter to wait until either:

- All pending operations are complete.
- The device clear command is received.
- Power is cycled.

before executing any subsequent commands or queries.

Syntax

 *WAI →

THIS PAGE HAS BEEN INTENTIONALLY LEFT BLANK.

Appendix A

———— Calibration Factor Block Layout

Calibration Factor Block Layout

The following tables provide information on the calibration factor block layout for E4410 Series, E9300 Series, E9320 Series and N8480 Series sensors (excluding Option CFT). The information relates to service commands described in Chapter 15.

Calibration Factor Block Layout: E4410 Series Sensors

E4410 Series Sensors: Calibration Factor Block Layout	No. Bytes	Contents	Data Format	Data Range	Units	Notes
Header:						
Power, low	2	-	7.8 (signed)	-127.9 to +127.9	dBm	Power for low power flatness.
Power, high	2	-	7.8 (signed)	-127.9 to +127.9	dBm	Power for high power flatness.
Number of freq. points	2	-	16 bit integer	-	None	
Bytes per freq. point	1	-	-	-	None	Number of bytes in cal factor value at each frequency and power level.
Freq. LSB weight	2	1000		-	Hertz	Fhbp (Freq. Hz per bit). 1 KHz per bit for the cal factor: 1KHz x 2 ³² = 4.3E+12 = 4300 GHz range
Header Total:	9					
Cal Factor Table:						
Frequency (point '0')	4	-	32 bit fixed	0 to Fhpb* (2 ³²)	None	Fhpb = Freq Hz per bit
Cal factor (low power) ¹	2	-	2.14	0.25 to 3	None	Power (in watts) is divided by this value.
Cal factor (high power) ¹	2	-	2.14	0.25 to 3	None	Power (in watts) is divided by this value.
These table entries are repeated as shown for each frequency point						
Frequency (point 'N')	4	-	32 bit fixed	0 to Fhpb* (2 ³²)	None	Fhpb = Freq Hz per bit
Cal factor (low power) ¹	2	-	2.14	0.25 to 3	None	Power (in watts) is divided by this value.

E4410 Series Sensors: Calibration Factor Block Layout	No. Bytes	Contents	Data Format	Data Range	Units	Notes
Cal factor (high power) ¹	2	-	2.14	0.25 to 3	None	Power (in watts) is divided by this value.
Table Size:	-	See note ¹				The table size is dependent on the number of freq. points.

Calibration Factor Block Layout: E9300 Series Sensors

E9300 Series Sensors: Calibration Factor Block Layout	No. Bytes	Contents	Data Format	Data Range	Units	Notes
Header:						
Number of tables	1	2			None	Number of cal factor tables. Note that the power levels and freq. points will be the same for all tables.
Number of freq. points	2	-	16 bit integer		None	
Bytes per freq. point	1	-	-	-	None	Number of bytes in cal factor value at each frequency and power level.
Freq. LSB weight	2	1000		-	Hertz	Fhbp (Freq. Hz per bit). 1 KHz per bit for the cal factor: 1KHz x 2 ³² = 4.3E+12 = 4300 GHz range.
Header Total:	6					
For Each Table (tables are in the order of lower to upper):						
Power, low	2	-	7.8 (signed)	-127.9 to +127.9	dBm	Power for low power flatness.
Power, high	2	-	7.8 (signed)	-127.9 to +127.9	dBm	Power for high power flatness.
Frequency (point '0')	4	-	32 bit fixed	0 to Fhpb* (2 ³²)	None	Fhpb = freq Hz per bit
Cal factor (low power) ¹	2	-	2.14	0.25 to 3	None	Power (in watts) is divided by this value.

Calibration Factor Block Layout
Calibration Factor Block Layout

E9300 Series Sensors: Calibration Factor Block Layout	No. Bytes	Contents	Data Format	Data Range	Units	Notes
Cal factor (high power) ¹	2	-	2.14	0.25 to 3	None	Power (in watts) is divided by this value.
These table entries are repeated as shown for each frequency point						
Frequency (point 'N')	4	-	32 bit fixed	0 to Fhpb* (2 ³²)	None	Fhpb = Freq Hz per bit.
Cal factor (low power)	2	-	2.14	0.25 to 3	None	Power (in watts) is divided by this value.
Cal factor (high power)	2	-	2.14	0.25 to 3	None	Power (in watts) is divided by this value.
Table size:	-	See note				The table size is dependent on the number of freq. points.

Calibration Factor Block Layout: E9320 Series Sensors³

E9320 Series Sensors: Calibration Factor Block Layout	No. Bytes	Contents	Data Format	Data Range	Units	Notes
Header:						
Number of tables	1	1	-	-	None	Number of cal factor tables. This is currently unused but has been set to a default value of 1.
Number of freq. points	2	-	16 bit integer	-	None	
Bytes per freq. point	1	-	-	-	None	Number of bytes in cal factor value at each freq.
Freq. LSB weight	2	1000		-	Hertz	Fhpb (Freq. Hz per bit). 1 KHz per bit for the cal factor: 1KHz x 2 ³² = 4.3E+12 = 4300 GHz range
Header Total:	6					
Cal Factor Table:						
Frequency (point '0')	4	-	32 bit fixed	0 to Fhpb* (2 ³²)	None	Fhpb = Freq Hz per bit

E9320 Series Sensors: Calibration Factor Block Layout	No. Bytes	Contents	Data Format	Data Range	Units	Notes
Cal factor ²	2	-	2.14	0.25 to 3	None	Used to adjust analog to digital converter (ADC) values.
These table entries are repeated as shown for each frequency point						
Frequency (point 'N')	4	-	32 bit fixed	0 to Fhpb* (2 ³²)	None	Fhpb = Freq Hz per bit
Cal factor	2	-	2.14	0.25 to 3	None	Used to adjust analog to digital converter (ADC) values.
Table Size:	-	See note ³				The table size is dependent on the number of freq. points.

Calibration Factor Block Layout: N8480 Series Sensors

N8480 Series Sensors: Calibration Factor Block Layout	No. Bytes	Contents	Data Format	Data Range	Units	Notes
Header:						
Power, low	2	-	7.8 (signed)	-127.9 to +127.9	dBm	Power for low power flatness.
Power, high	2	-	7.8 (signed)	-127.9 to +127.9	dBm	Power for high power flatness.
Number of freq. points	2	-	16 bit integer	-	None	
Bytes per freq. point	1	-	-	-	None	Number of bytes in cal factor value at each frequency and power level.
Freq. LSB weight	2	1000		-	Hertz	Fhpb (Freq. Hz per bit). 1 KHz per bit for the cal factor: 1KHz x 2 ³² = 4.3E+12 = 4300 GHz range
Header Total:	9					
Cal Factor Table:						
Frequency (point '0')	4	-	32 bit fixed	0 to Fhpb* (2 ³²)	None	Fhpb = Freq Hz per bit

Calibration Factor Block Layout
Calibration Factor Block Layout

N8480 Series Sensors: Calibration Factor Block Layout	No. Bytes	Contents	Data Format	Data Range	Units	Notes
Cal factor (low power) ¹	2	-	2.14	0.25 to 3	None	Power (in watts) is divided by this value.
Cal factor (high power) ¹	2	-	2.14	0.25 to 3	None	Power (in watts) is divided by this value.
These table entries are repeated as shown for each frequency point						
Frequency (point 'N')	4	-	32 bit fixed	0 to Fhpb* (2 ³²)	None	Fhbp = Freq Hz per bit
Cal factor (low power) ¹	2	-	2.14	0.25 to 3	None	Power (in watts) is divided by this value.
Cal factor (high power) ¹	2	-	2.14	0.25 to 3	None	Power (in watts) is divided by this value.
Table Size:	-	See note ¹				The table size is dependent on the number of freq. points.

1. Corrections are applied in power for E4410, E9300 and N8480 Series sensors (excluding Option CFT).
2. Corrections are applied in voltage versus ADC reading for E9320 Series sensors. This format also requires only one correction factor across all power levels.
3. The block layout shown for E9320 Series sensors exists in two separate EEPROM locations. One location contains the calibration factor data for the average path and the other contains the calibration factor data for the peak path. These EEPROM blocks are accessed using the `SERV:SENS:CALFactor` and `SERV:SENS:PCALfactor` commands respectively.

Index

Numerics

1234 A-5

A

abort command 13-3

address

 GPIB 1-3

 setting 11-4

analog meter

 setting lower limit 5-10, 5-17

 setting upper limit 5-12, 5-19

ASCII output format 1-72

autoranging

 enabling/disabling 9-47

averaging 1-57, 1-58, 9-5

 auto averaging 1-58

 enabling/disabling 9-8, 9-13, 9-17

 filter length 1-60, 9-15

B

bandwidth

 setting 9-18

baud rate 11-17

 setting 11-9, 11-18

BLUetooth

 preset values 11-43

Bluetooth

 measuring 1-32

boolean

 definition 1-99

C

CALC block

 input measurement mode 3-4

CALCulate blocks 3-2

CALCulate commands

 summary 1-108

CALCulate subsystem 3-2

 calibrating 1-5, 4-3, 4-5, 4-7

 reference calibration factor 4-12

 calibrating and zeroing 4-2

 calibrating summary register 10-12

CALibration commands

 summary 1-109

calibration date

 sensor 15-13

calibration factor

 reading/writing data 15-11

calibration factor block layout A-1

 E4410 series sensors A-2, A-5

 E9300 series sensors A-3

 E9320 series sensors A-4

calibration factor/offset points

 returning number of 7-28

calibration factors

 entering 9-20

 entering into tables 7-26

calibration inputs

 enabling/disabling 4-9

calibration lockout

 enabling/disabling 4-10

calibration place

 sensor 15-16

CALibration subsystem 4-2

calibration summary register 10-21

caution -iii

cdma2000

 measuring 1-38

 preset values 11-52

cdmaone

 measuring 1-34

 preset values 11-46

channel offset

 enabling/disabling 9-36

- loss 9-38
- setting 9-38
- channel offsets 1-61
- channel trace display 5-26
- character_data
 - definition 1-100
- clear status command 16-6
- clearing peak hold value 3-28
- command summary 1-106
- condition register 1-76
 - contents of 10-4
- configurations
 - recalling 1-95
 - saving 1-95
- CONFigure
 - examples 1-14
 - using 1-14
- contrast
 - display 5-3
- control
 - front panel 11-27, 11-58, 11-60
 - local 11-27, 11-58
 - remote 11-58, 11-60
- corrected power 15-14
- correction
 - loss 9-35
- CORRection commands 9-20

D

- danger -iii
- data format 6-2
- default
 - preset values 11-30
- define device trigger command 16-7
- delay
 - between delayed trigger point and start of trace 9-61
 - setting 9-61
 - triggering 13-19, 13-25
- device clear 1-96
- device clear command 16-3
- device status registers 1-91, 10-8
- difference measurement 3-25
- display
 - contrast 5-3
 - enabling/disabling 5-5
 - selecting 5-24
 - selecting the format 5-14
 - setting analog meter lower limit 5-10, 5-17
 - setting analog meter upper limit 5-12, 5-19
 - setting the format 5-6
- display commands
 - summary 1-109
- display offset
 - enabling/disabling 3-9
 - setting 3-7
- display offsets 1-61
- DISPlay subsystem 5-2
- display window commands 5-8
- DTR
 - setting 11-7
- dual window 5-24
- duty cycle 1-67
 - enabling/disabling 9-32
 - setting 9-29
- duty cycle values
 - entering 9-20

E

- E4410 series sensors
 - calibration factor block layout A-2, A-5
- E9300 series sensors
 - calibration factor block layout A-3
- E9320 series sensors
 - calibration factor block layout A-4
- echo mode
 - enabling/disabling 11-21
- EDGE
 - measuring 1-25
 - preset values 11-37
- enable register 1-77
 - setting 10-5
- event register 1-76
 - contents of 10-4
- event status enable command 16-9
- external gains and losses
 - entering 9-20

F

- fail limits 1-63
- falling edge 13-29

- detecting 13-23
- fast path accuracy test 15-6
- FETCh?
 - using 1-14
- filter length 1-60
 - averaging 9-15
 - setting 9-6
- filtering
 - enabling/disabling 9-8
- format
 - transferring binary data 6-3
 - transferring numeric data 6-4
- FORMat commands
 - summary 1-109
- FORMat subsystem 6-2
- frequency
 - entering 9-42
 - maximum 15-17
 - minimum 15-18
- frequency data
 - entering into tables 7-22
- frequency dependent offset 9-34
- frequency dependent offset tables 1-50, 7-2
 - clearing data 7-11, 7-12
 - editing 1-52
 - enabling/disabling 1-55, 9-26
 - entering frequency 7-22
 - entering offsets 7-26
 - listing 1-53, 7-5, 7-8
 - modifying data 1-55
 - naming 1-54
 - overview 1-50
 - renaming 7-29
 - returning frequency points 7-25
 - returning number of calibration factor/offset points 7-28
 - reviewing data 1-54
 - selecting 1-55, 7-30, 9-24
- frequency dependent offsets
 - entering into tables 7-26
- frequency points
 - returning 7-25
- front panel
 - locking 11-58, 11-60
 - unlocking 11-27
- front panel control 11-27, 11-58, 11-60

G

- gain correction
 - enabling/disabling 9-36
 - setting 9-21
- gains and losses 9-20
- go to local command 16-3
- GPIB 11-59
 - configuring 1-3
- GPIB address 1-3
 - setting 11-4
- group execute trigger command 16-3
- GSM
 - measuring 1-24
- GSM900
 - preset values 11-34

H

- handshake 11-13, 11-22

I

- iDEN
 - measuring 1-30
 - preset values 11-43, 11-55
- identification query 16-11
- idle state 13-3
- IEEE commands 16-2
- INITiate
 - using 1-14
- initiate commands 13-4
- input measurement mode
 - CALC block 3-4
 - setting 3-4
- introduction to SCPI 1-97

L

- legal information -iii
- limit failures 1-65
- limits 1-63
 - clearing fail counter 3-12, 3-14
 - enabling/disabling 3-22
 - fail 3-15
 - fail count 3-16
 - lower 3-18
 - setting 1-63
 - setting, querying, counting, clearing 3-11

- upper 3-20
- limits fail
 - TTL outputs 8-12
- limits test
 - TTL outputs 8-14
- linear units 1-72
- linearity correction
 - selecting 9-66
- local control 11-27, 11-58
- local lock out command 16-3
- log units 1-72
- loss correction 9-35, 9-38
- lower limit
 - setting on the analog meter 5-10, 5-17
- lower limit fail summary register 10-13
- lower scale limit
 - setting on the trace window 5-28, 9-57

M

- making measurements 1-8, 1-55
 - measurements
 - making** 1-24
- math expressions
 - listing 3-27
 - setting 3-25
- maximum average power 15-20
- maximum frequency 15-17
- maximum peak power 15-21
- maximum usable power 15-22
- MEASure
 - using 1-9
- measured power 15-4
- measurement
 - sending to recorder output 8-3
- MEASurement commands
 - summary 1-107
- measurement correction
 - loss 9-35
- measurement limits 1-63
- measurement mode
 - setting 9-40
- measurement output format 1-72
- measurement rate 1-70
- measurement resolution 5-21

- measurement selection 5-23
- measurement speed
 - setting 9-44, 9-49
- measurement units
 - setting 14-3, 14-6
- measurements
 - making 1-8, 1-55
- measuring summary register 10-14
- memory
 - amount available 7-14, 7-15, 7-16
- MEMory commands
 - summary 1-111
- MEMory subsystem 7-2
- minimum frequency 15-18
- minimum usable power 15-23

N

- NADC
 - measuring 1-27
 - preset values 11-40
- NAN
 - definition 1-100
- negative transition register
 - setting 10-6
- non-decimal numeric
 - definition 1-101
- NR1
 - definition 1-102
- NR2
 - definition 1-102
- NR3
 - definition 1-103
- NRf
 - definition 1-102
- numeric_value
 - definition 1-103

O

- offset time
 - setting 9-51, 9-52
- offsets
 - channel 1-61
 - display 1-61
 - setting 1-61
- operation complete command 1-93, 16-12

- operation register sets 10-10
- operation status registers 1-89, 10-11
- options
 - loading 15-10, 15-19
 - querying 15-10, 15-19
- options installed query 16-13
- OUTput commands
 - summary 1-111
- output format 1-72
- OUTput subsystem 8-2
- overview -v

P

- parallel poll enable command 16-4
- parallel poll unconfigure command 16-5
- parallel port configure command 16-4
- parallel port disable command 16-4
- parity 11-17
- parity checking
 - setting 11-23
- parity type
 - setting 11-14
- pass limits 1-63
- peak hold value
 - clearing 3-28
- performance 1-70
- positive transition register
 - setting 10-7
- power
 - average maximum 15-20
 - maximum peak 15-21
 - maximum usable 15-22
- power level
 - setting 13-25
- power measured 15-4
- power measurement units
 - setting 14-3
- power meter
 - options 15-10, 15-19
 - processor revision 15-29
 - serial number 15-28
 - system version 15-30
- power minimum usable 15-23
- power range
 - selecting 9-46

- power reference output
 - enabling/disabling 8-10
- power summary register 10-22
- preset 11-28
- preset values 11-28
 - BLUetooth 11-43
 - cdma2000 11-52
 - cdmaone 11-46
 - default 11-30
 - EDGE 11-37
 - GSM900 11-34
 - iDEN 11-43, 11-55
 - NADC 11-40
 - wcdma 11-49
- processor revision
 - power meter 15-29
- pulse power 9-28, 9-29
 - enabling/disabling 9-32
- pulsed signals
 - measuring 1-67

Q

- questionable register set 10-20
- questionable register sets 10-19
- questionable status register 1-87

R

- range 1-57
 - selecting 9-46
 - setting 1-57
- ratio measurement 3-25
- ratio units
 - setting 14-6
- raw ADC measurement 15-24
- READ?
 - using 1-14
- REAL output format 1-72
- recall
 - registers available 7-17
- recall command 1-95, 16-14
- recall register
 - listing 7-19
- recall registers
 - clearing data 7-11
 - listing 7-5, 7-7

- naming 7-20
- receiver handshake
 - enabling/disabling 11-13
- recorder output
 - enabling/disabling 8-9
 - measurement 8-3
 - setting maximum scaling value 8-7
 - setting minimum scaling value 8-5
- reference calibration factor 4-2
 - querying 1-7
 - setting 1-7, 4-12
- reference value
 - setting 3-30
- reference voltage 15-5
- registers
 - available for save/recall 7-17
- relative mode
 - enabling/disabling 3-32
- relative value
 - setting 3-30
- remote control 11-58, 11-60
- remote control interface
 - selecting 11-59
- remote interface
 - configuring 1-3
- renaming tables 7-29
- reset command 16-15
- resolution 1-57, 1-58, 5-21
- rising edge
 - detecting 13-23
- RS232/RS422 11-59
 - configuring 1-3, 1-4
 - settings 11-6
- RTS
 - setting 11-8

S

- safety -iii
- save command 1-95, 16-16
- save/recall
 - registers available 7-17
- save/recall register
 - listing 7-19
- save/recall registers 7-2
 - clearing data 7-11

- listing 7-5, 7-7
- naming 7-20
- scaling value
 - setting maximum value 8-7
 - setting minimum value 8-5
- SCPI
 - compliance information 1-119
 - introduction 1-97
- SCPI commands
 - listing 11-26
- SCPI version 11-61
- screen
 - contrast 5-3
 - enabling/disabling 5-5
 - setting the format 5-6
- select device clear command 16-5
- selecting tables 7-30
- self test
 - enabling/disabling 15-3
- self test query 16-22
- SENSe
 - AVERage commands 9-5
- SENSe commands
 - summary 1-113
- SENSe subsystem 9-2
- sense summary register 10-15
- sensor bandwidth
 - setting 9-18
- sensor calibration date 15-13
- sensor calibration place 15-16
- sensor calibration table
 - selecting 1-48, 7-30
- sensor calibration tables 1-40, 7-2
 - clearing data 7-11, 7-12
 - editing 1-43
 - enabling 1-48
 - enabling/disabling 9-26
 - entering calibration factors 7-26
 - entering frequency 7-22
 - listing 1-44, 7-5, 7-8
 - naming 1-46
 - renaming 7-29
 - returning frequency points 7-25
 - returning number of calibration factor/offset points
 - 7-28
 - selecting 9-24

- sensor frequency 15-17, 15-18
- sensor serial number
 - serial number
 - sensor** 15-25
- sensor tracking number 15-26
- sensor type 15-27
- serial interface
 - setting 11-7, 11-8
 - settings 11-6
- serial number
 - loading 15-28
- serial port disable command 16-5
- serial port enable command 16-5
- SERVice commands
 - summary 1-118
- service request enable command 16-17
- SERVice subsystem 15-2
 - setting 11-20
- setting display offset 3-7
- setting input measurement mode 3-4
- setting math expressions 3-25
- settling time delay
 - enabling/disabling 13-14
 - setting 13-33
- single window 5-24
- speed 1-70
 - setting 9-44, 9-49
- standard event register 1-85
- standard event status register query 16-10
- status byte query 1-85, 16-19
- status byte summary register 1-84
- STATus commands
 - summary 1-115
- status register model 1-76
- status registers 1-83
 - examining 10-2
- status reporting 1-75
- STATus subsystem 10-2
- step detection
 - enabling/disabling 9-11
- stop bits 11-17
 - setting 11-16, 11-25
- string
 - definition 1-104

- summary
 - commands 1-106
- supported commands
 - listing 11-26
- SYSTEM commands
 - summary 1-116
- SYSTEM subsystem 11-2
- system version
 - power meter 15-30

T

- testing
 - enabling/disabling 15-3, 15-6
 - fast path accuracy 15-6
 - time base signal 15-7
- time base signal 15-7
- time gate length
 - setting 9-51, 9-54
- trace
 - setting which channel's trace is displayed 5-26
- trace capture
 - enabling/disabling 12-5
- TRACe commands
 - summary 1-116
- trace data
 - resolution 12-3
- trace display 5-26
- trace duration
 - setting 9-63
- TRACe subsystem 12-2
- trace units
 - setting 9-65, 12-6
- trace window
 - setting lower scale limit 5-28, 9-57
 - setting upper scale limit 5-30, 9-59
- tracking number
 - sensor 15-26
- transferring binary data
 - format 6-3
- transferring numeric data
 - format 6-4
- transition filter 1-76
- transmitter handshake
 - enabling/disabling 11-22
- trigger command 16-21

- TRIGger commands
 - summary 1-117
- trigger commands 13-13
- trigger cycle
 - continuous 13-5, 13-9
 - setting 13-9
 - single 13-5, 13-9
- trigger cycle,setting 13-5
- trigger delay
 - over-ride 13-35
 - setting 13-19
- trigger event 13-25
 - recognizing
 - rising edge 13-29
- trigger events
 - setting 13-31
- trigger holdoff
 - setting 13-21
- trigger immediate 13-16
- trigger in/out
 - querying 15-9
- trigger level
 - automatic setting 13-27
 - enabling/disabling 13-27
 - querying 15-8
- trigger output signal
 - enabling/disabling 8-11
- trigger sequences
 - continuously initiated 13-8
 - initiating 13-11
 - setting 13-8
- trigger source
 - setting 13-17, 13-36
- TRIGger subsystem 13-2
- trigger summary register 10-16
- triggering 1-71
- TTL outputs 8-2
 - enabling/disabling 8-16
 - limits fail 8-12
 - limits test 8-14

- U**
- uncorrected measurement 15-24
- UNIT commands
 - summary 1-117

- UNIT subsystem 14-2
- units 1-72
- upper limit
 - setting on the analog meter 5-12, 5-19
- upper limit fail summary register 10-17
- upper scale limit
 - setting on the trace window 5-30, 9-59
- user environment -iv

V

- version 11-61
- video averaging
 - enabling/disabling 9-17
- video filter length
 - averaging 9-15
- voltage
 - reference 15-5
- voltage to corrected power conversion
 - enabling/disabling 15-14

W

- wait command 16-23
- wait for trigger state 13-3, 13-4, 13-5
 - setting 13-7, 13-12
- warning -iii
- W-CDMA
 - measuring 1-36
- wcdmapreset values 11-49
- window
 - selecting 5-24
 - selecting the format 5-14
- window resolution 5-21
- window selection 5-23
- word length 11-17, 11-20
 - setting 11-11

X

- Xon/Xoff 11-13, 11-22

Z

- zeroing 1-5, 4-14, 4-15
- zeroing and calibrating 4-2